

## Pre-set thermostat NC



### Description

<b>Order Number:</b>	301010
<b>Brand Name:</b>	SOLIFLEX
<b>Colour:</b>	Grey RAL 7011
<b>Housing Material:</b>	PC plastic
<b>IP protection class to EN 60 529:</b>	IP 20
<b>Note:</b>	Hyst.10±2K / Sw.Pt.tol ±2K
<b>Approvals:</b>	CE, cURus
<b>UL File Number:</b>	E358385

## Technical Data

<b>Operating Temperature Range:</b>	-45°C - 120°C / -40°C - 80°C (UL)
<b>Setting range:</b>	OFF 15°C/59°F - ON 5°C/41°F
<b>Mounting:</b>	DIN Rail 35 mm
<b>Dimensions A x B x C (D+E):</b>	60 x 39 x 38.9 mm
<b>Weight:</b>	~ 50 g
<b>Voltage / Frequency:</b>	max. 250 V AC 16 A(res) / 10 A(ind) max. 72 V DC max. 30 W
<b>Lifetime:</b>	30k Cycles
<b>Connection:</b>	2-pole terminal, clamping torque 0.5 Nm max. solid wire - 2.5 mm <sup>2</sup> max. stranded wire - 1.5 mm <sup>2</sup> max.

Please click on the graphics to download.

More CAD drawings can be found under [Product Download](#).

> [Overview Product Group SOLIFLEX - thermostats and hygrostats for enclosures](#)

**Cut out Dimensions:**

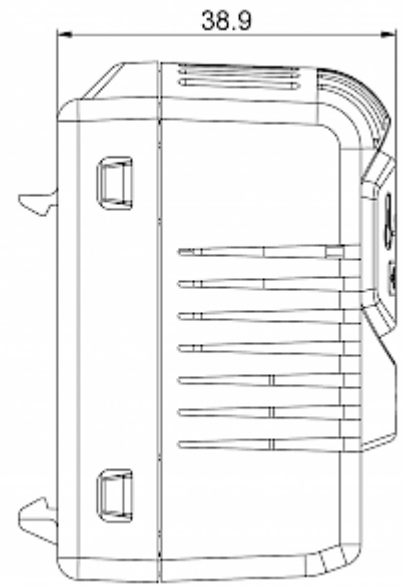
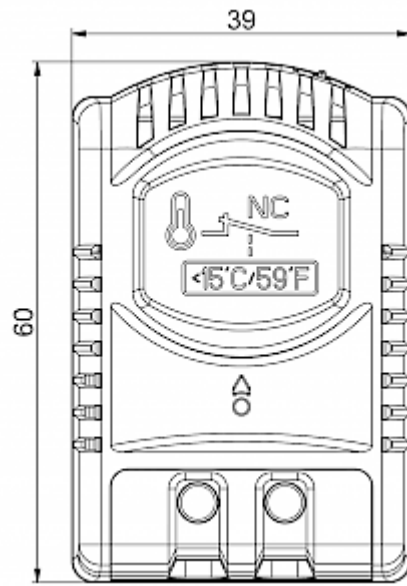

[click image to enlarge](#)

## Order Information

<b>Taric code</b>	90321080
<b>GTIN (EAN)</b>	5350604010024