

Pre-set Thermostat NC



Description

| | |
|--|----------------------------|
| Order Number: | 301005 |
| Brand Name: | SOLIFLEX |
| Colour: | Grey RAL 7011 |
| Housing Material: | PC plastic |
| IP protection class to EN 60 529: | IP 20 |
| Note: | Hyst.10±2K / Sw.Pt.tol ±2K |
| Approvals: | CE, cURus |
| UL File Number: | E358385 |

Technical Data

| | |
|-------------------------------------|--|
| Operating Temperature Range: | -45°C - 120°C / -40°C - 80°C (UL) |
| Setting range: | OFF 10°C/50°F - ON 0°C/32°F |
| Mounting: | DIN Rail 35 mm |
| Dimensions A x B x C (D+E): | 60 x 39 x 38.9 mm |
| Weight: | ~ 50 g |
| Voltage / Frequency: | max. 250 V AC 16 A(res) / 10 A(ind) max. 72 V DC max. 30 W |
| Lifetime: | 30k Cycles |
| Connection: | 2-pole terminal, clamping torque 0.5 Nm max. solid wire - 2.5 mm ² max. stranded wire - 1.5 mm ² max. |

Please click on the graphics to download.

More CAD drawings can be found under [Product Download](#).

> [Overview Product Group SOLIFLEX - thermostats and hygrostats for enclosures](#)

Cut out Dimensions:

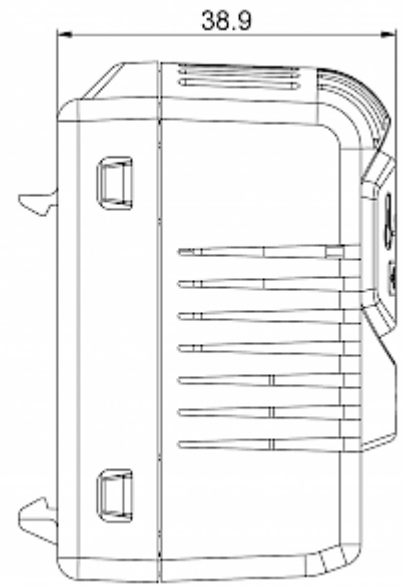
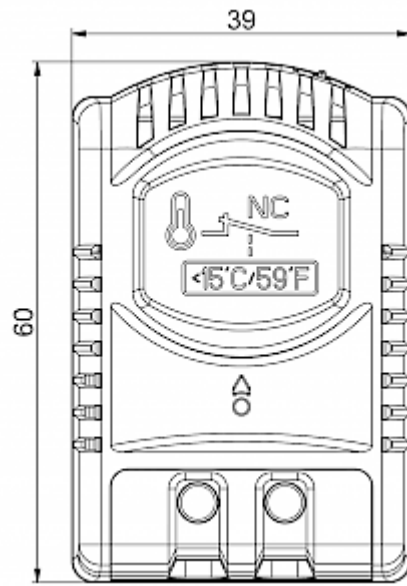

[click image to enlarge](#)

Order Information

| | |
|-------------------|---------------|
| Taric code | 90321080 |
| GTIN (EAN) | 5350604010000 |