

Fan assisted resistor heater



Description

Order Number:	503750
Brand Name:	SOLIFLEX
Colour:	silver
Housing Material:	Aluminum
IP protection class to EN 60 529:	IP 20
Note:	PTC resistance self-regulating
Approvals:	CE, cURus
Accessories:	 Adjustable thermostat NC

Technical Data

Heating power at 10°C:	750 W
Operating Temperature Range:	-25°C - 70°C
Mounting:	DIN rail
Dimensions A x B x C (D+E):	225 x 82 x 112 mm
Weight:	1.35 kg
Voltage / Frequency:	230 V ~ 50/60 Hz
Max. current:	3.6 A
Fan air flow, approx.:	44 m ³ /h
Connection:	3 screw terminals for stranded or rigid wire 2.5 mm ²

Please click on the graphics to download.
More CAD drawings can be found under [Product Download](#).
> [Overview Product Group SOLIFLEX - enclosure Heaters](#)

Cut out Dimensions:

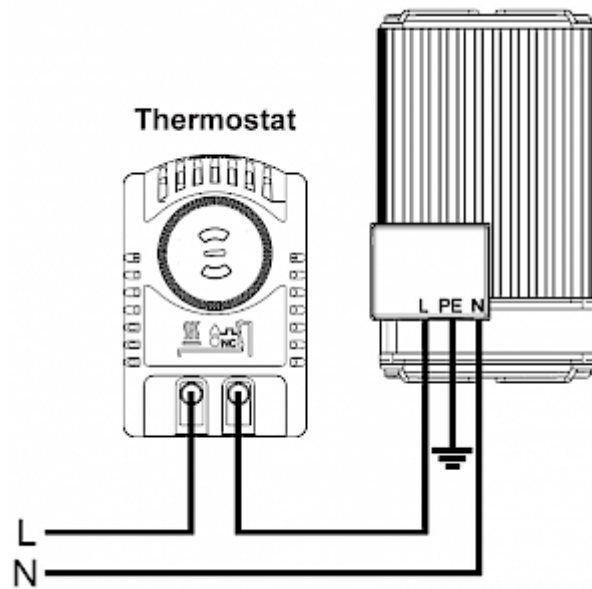

[click image to enlarge](#)

Order Information

Taric code	85162999
GTIN (EAN)	5350604020160