

Filter fan SF 4711 - 120V



Description

Order Number:	4711122001
Brand Name:	SOLIVENT PRO
Colour:	RAL 7035
Housing Material:	PC plastic
IP protection class to EN 60 529:	IP 54
UL Typ (UL 50E):	12
Approvals:	CE, cURus, cULus
UL File Number:	E498756

Accessories:



[Hose-proof protection hood FC 4000 000](#)



[Hose-proof protection hood FC 4000 000 FDA](#)



[Thermostat 301050](#)

Technical Data

Air flow unimpeded IP 54:	21 / 23 m ³ /hr
Air flow with exhaust filter IP 54:	12 / 13 m ³ /hr
Air flow with 2 exhaust filters IP 54:	17 / 18 m ³ /hr
Operating Temperature Range:	-10°C - 60°C
Storage temperature range:	-40°C - 70°C
Mounting:	Wall mounted
Dimensions A x B x C (D+E):	115.5 x 115.5 x 80.6 (11.6+69) mm
Weight:	0.3 kg
Cut out dimensions:	92 x 92 mm
Voltage / Frequency:	120 V ~ 50/60 Hz
Rated current:	0.22 / 0.21 A
Power consumption:	3.2 / 3.3 W
Noise level:	32 dB(A)
Fuse:	1 A (T)
Connection:	Spring clamp

Please click on the graphics to download.

More CAD drawings can be found under [Product Download](#).

> [Overview Product Group SOLIVENT PRO - Filter fans & exhaust filters](#)

Air flow:

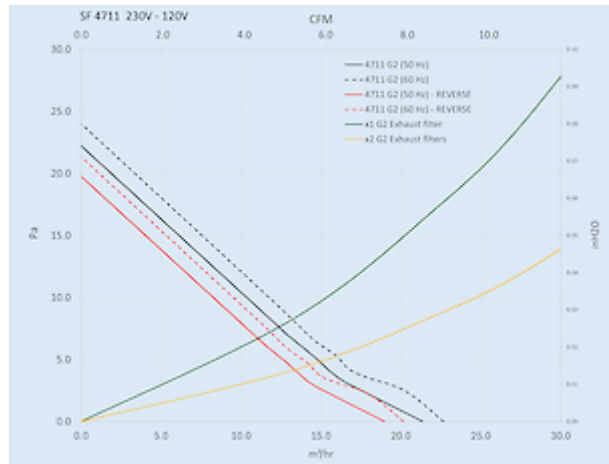

click image to enlarge

Cooling capacity:

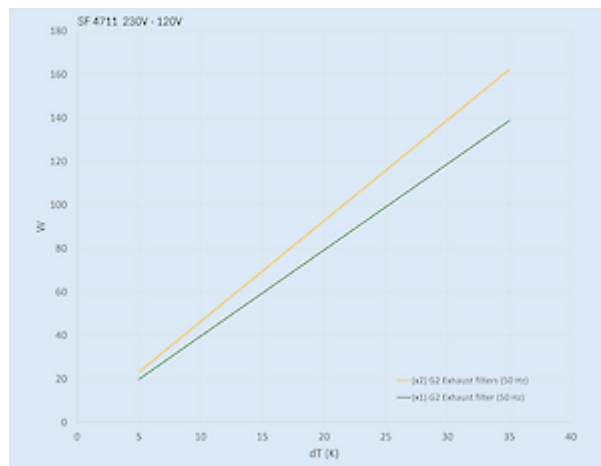

click image to enlarge

Cut out Dimensions:

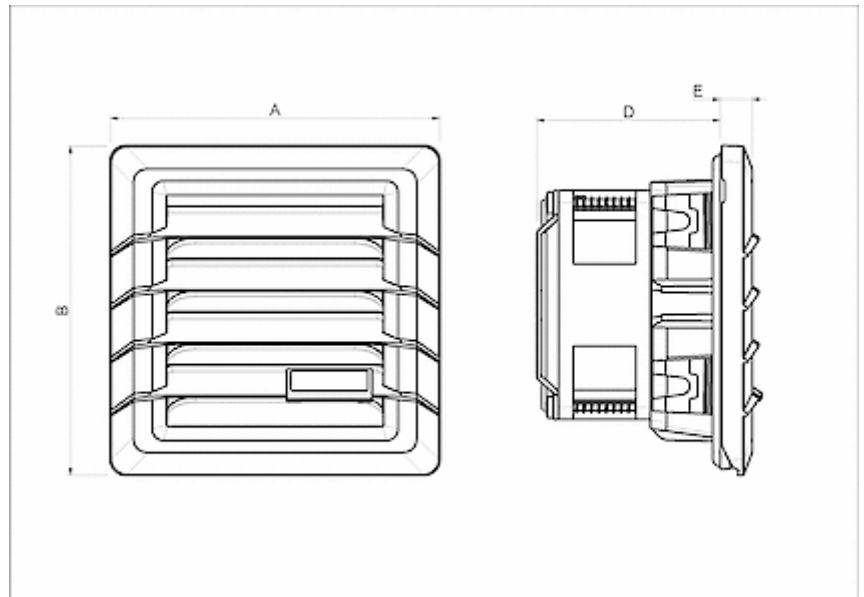

click image to enlarge

Order Information

Order number	IP rating	UL Type	RAL colour	Flow type ¹⁾	Air flow (m ³ /h) ²⁾	Air flow with exhaust filter (m ³ /h)
4711122001	54	12 / 3R	RAL 7035	B	21 / 23 m ³ /hr	12 / 13 m ³ /hr
4711122003	54	12 / 3R	RAL 9005	B	21 / 23 m ³ /hr	12 / 13 m ³ /hr
471112R2001	54	12 / 3R	RAL 7035	S	19 / 20 m ³ /hr	N/A
471112R2003	54	12 / 3R	RAL 9005	S	19 / 20 m ³ /hr	N/A

¹⁾ B = Blowing - from ambient into the enclosure (standard version)
 S = Suction - from enclosure to ambient (on request)

²⁾ unimpeded 50/60 Hz