

Exhaust filter for SF 4720



Description

Order Number:	4720902001
Brand Name:	SOLIVENT PRO
Colour:	RAL 7035
IP protection class to EN 60 529:	IP 54
UL Typ (UL 50E):	12
Approvals:	CE, cURus, cULus
UL File Number:	E498756

Accessories:



[Hose-proof protection hood FC 4000 200 FDA](#)



[Hose-proof protection hood FC 4000 200](#)



[Thermostat 301050](#)

Technical Data

Operating Temperature Range:	10°C - 60°C
Storage temperature range:	-40°C - 70°C
Mounting:	Wall mounted
Dimensions A x B x C (D+E):	204.5 x 204.5 x 43.1 mm
Weight:	400 g.
Cut out dimensions:	177 x 177 mm

Please click on the graphics to download.

More CAD drawings can be found under [Product Download](#).

> [Overview Product Group SOLIVENT PRO - Filter fans & exhaust filters](#)

Cut out Dimensions:

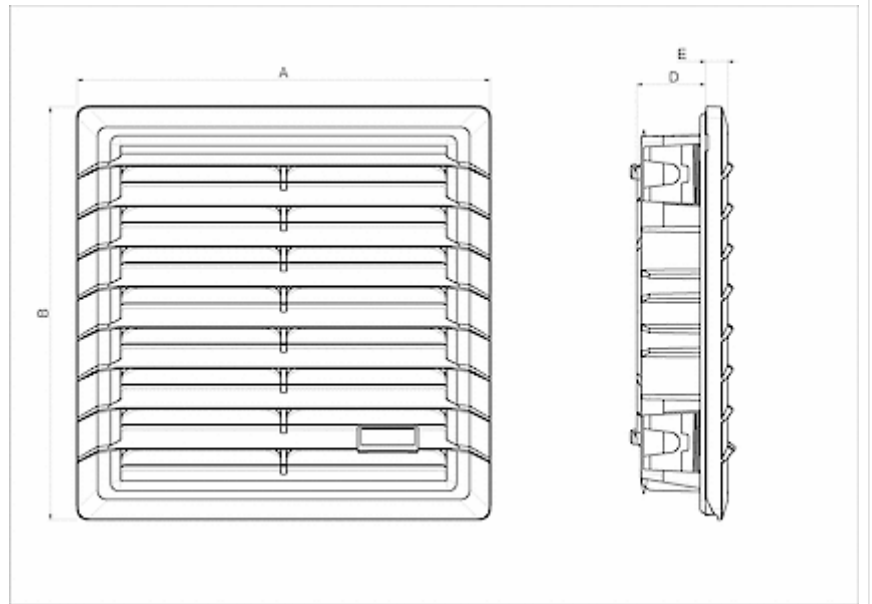

[click image to enlarge](#)

Order Information

Order number	IP rating	UL Type	RAL colour	Flow type ¹⁾	Air flow (m ³ /h) ²⁾	Air flow with exhaust filter (m ³ /h)
4720902001	54	12 / 3R	RAL 7035	N/A	N/A	N/A
4720902003	54	12 / 3R	RAL 9005	N/A	N/A	N/A
4720903001	55	12 / 3R	RAL 7035	N/A	N/A	N/A
4720903003	55	12 / 3R	RAL 9005	N/A	N/A	N/A

¹⁾ B = Blowing - from ambient into the enclosure (standard version)
S = Suction - from enclosure to ambient (on request)

²⁾ unimpeded 50/60 Hz

Taric ode 84145915