



THERMAL MANAGEMENT FOR ENCLOSURES AND MACHINERY

SEIFERT SYSTEMS
GENERAL CATALOGUE 22.1

INNOVATION FOR TOMORROW'S REQUIREMENTS

EVERY CHALLENGE HAS ITS OWN SOLUTION

INNOVATION IS THE FUTURE!

Companies and entrepreneurs are facing a completely new situation at the beginning of this decade. Technological progress and increasing globalisation challenge them.

Production capacities need to be expanded and manufacturing processes are automated. Digitalisation and new electronic systems are creating more efficient processes, but also tougher competition.

Today's companies need good partners. Seifert Systems is such a partner. We recognise individual needs and offer security. We have been doing so for generations.

In 1965, my father, Rolf Seifert founded the company Ing. Rolf Seifert GmbH. He cooled the electronics in control cabinets in selected German companies and prepared a regulated temperature level for the machines.

Today, there is a worldwide market for industrial cooling with very different requirements and my father's individual company has become the international Seifert Systems group of companies. We are experts in individual solutions, from filter fans to professional cooling units in process and automation technology.

As different as the applications may be, we advise our customers in an individual and personal way, some of which we have done so for decades. They come from the most diverse sectors, each with their own complex requirements.

Enclosure and mechanical engineering, telecommunications, renewable energies, the food processing industry, lasers and additive manufacturing are just a few of the applications which are cooled, ventilated and dehumidified by our products.



In this general catalogue you will find information about the company and a detailed overview of our products and services. You can read about how, when and which products are used and who your contacts are in our company.

My team and I accompany your projects from the drawing board to series production. We offer solutions and the foundation for high performance.

Yours sincerely

Michael Seifert

TABLE OF CONTENTS

EVERYTHING AT A GLANCE

We present the first general catalogue of the Seifert Systems group of companies, thermal management products for the highest, technical requirements built with passion and the art of engineering.

We are the market specialist for air conditioning products, known and appreciated for individual solutions and series production.

If you have any questions or suggestions, please contact us!

CONTENTS

Seifert Systems - the company	6
History	8
Global Presence	10
Applications	12
Service	14
Sustainability	16

PRODUCTS

Product reference table	18 - 19
-----------------------------------	---------

ENCLOSURE COOLING UNITS INDOOR

SLIMLINE PRO & VARIO	20 - 32
SLIMLINE ORIGINAL	36 - 45
SOLITHERM TOP (roof mounted)	46 - 49
COMPACT INDOOR	50 - 63

ENCLOSURE COOLING UNITS OUTDOOR, UL TYPE 4X, CORROSION RESISTANT

COMPACT OUTDOOR	64 - 75
SOLITHERM PROTEC	76 - 81

SOLITHERM PELTIER, ATEX CLASSIFIED

Thermoelectric cooling units, dehumidifier	82 - 99
--	---------

SOLITHERM 19" RACK

Cooling units / heat exchangers for 19" racks	100 - 105
---	-----------

SLIMLINE HEX HEAT EXCHANGER

Air / water heat exchangers	106 - 127
---------------------------------------	-----------

SOLITHERM CHILL

Chillers	128 - 131
--------------------	-----------

SLIMLINE HEX HEAT EXCHANGER

Air / air heat exchangers	132 - 139
-------------------------------------	-----------

SOLIFLEX FILTER FANS / EXHAUST FILTER

Filter fans / exhaust filters	140 - 153
Roof mounted filter fans	154 - 159
Protection hoods for filter fans	160 - 161

SOLIFLEX ENCLOSURE HEATER

Heaters / fan heaters	162 - 169
---------------------------------	-----------

SOLIFLEX ACCESSORIES

Thermostats / Hygrostats / Sensors	170 - 175
--	-----------

ENCLOSURE LIGHTING

STRIPLITE LED enclosure lights	176 - 181
Explanation on approvals and protection classes	182 - 183
The right product for your requirements	184 - 186
Explanation on symbols used	187

SUBSIDIARIES

Overview & contact details	188 - 189
--------------------------------------	-----------



AIR CONDITIONING SOLUTIONS FOR FUTURE GENERATIONS

The foundation of Seifert Systems was laid in Ennepetal in 1965. Engineer Rolf Seifert recognised the need to keep electronics in an industrial environment at a constant temperature level and to safely dissipate heat from enclosures.

Rolf's son Michael Seifert took over the management of the company in 2005 and has since been consistently expanding the company through international sales organisations and new production sites.

Wibke Seifert, Michael's wife, supports the individual companies within the group through Seifert Holding GmbH. In the third generation, Philipp Seifert joined the company in 2016. After six years of studying and working in the USA, he is now responsible for the structures and processes in the production facilities as well as for the digitalisation of workflows and new technologies.

With more than 55 years of experience, Seifert Systems has grown into a group of companies with its own subsidiaries in Germany, Austria, Switzerland, Malta, Italy, the USA and Australia.

In addition to these, long-standing partnerships in all parts of the world enable us to operate internationally to the highest degree.

Our most important goal is to constantly live up to our leading market position in the air conditioning of enclosures and machines.

For us, innovation means not only finding a solution approach, but also implementing it, applying it and successfully placing it on the market. "Wegweisend innovativ" combines vision and commitment in everything we do.



SEIFERT SYSTEMS' SMART FACTORY



Only sustainable action, resource-saving production and ecological and social responsibility shall lead to success in the long term.

Seifert Systems has already laid the foundation for the digital transformation within the company and is investing in the latest technologies and optimising internal processes.

The Seifert Group's first Smart Factory was built in Malta by means of a plant expansion. The new building accommodates a new metal and surface processing facility as well as a new logistics area.

The intelligent production consistently follows the Industry 4.0 principle and will help to produce our products more efficiently and in a more environmentally friendly manner. In this way, we secure delivery capability and growth targets for Seifert Systems and for our customers.

PAST PRESENT FUTURE

1965

Founded by Ing. Rolf Seifert GmbH. Production of heat sinks for the broadcasting industry.



1974

Expansion of the portfolio: Vacuum-brazed copper and aluminum heat sink plates, water as a cooling medium.

1978

Expansion of the portfolio: Heat exchangers and enclosure cooling units.

1988

Founded Seifert Systems AG, Switzerland.



1990

Expansion of the portfolio: Chillers for plant and machinery.

1991

Founded Seifert Systems Ltd. in Malta, second production site.



1995

Expansion of the portfolio: Heat exchanger solutions for the US telecom market.

2000

Founded Seifert Systems Inc. in Rhode Island, USA.



2010

Founded Seifert Systems Pvt. Ltd. in Victoria, Australia.



2015 50 Years Seifert

With the ISO14001 certification, Seifert Systems introduces environmental management standards for the entire group.

50

2017

Expansion of the portfolio: Founding of the new EMS / CEM Industrial Services division at Seifert Systems Malta

2019

New production facility for chiller in Radevormwald, Germany.



2019

Opening of a sales office in Cremona, Italy.

2020

As the first location of the group of companies, the factory in Malta manufactures completely climate neutral.

carbon
neutral

2021

Expansion of the production area and logistics center in Radevormwald, Germany.



2021

Founded Seifert Systems GmbH in Ottnang, Austria.

2022

Construction of a Smart Factory based on Industry 4.0 in Malta.



2023

Smart Factory official inauguration.





SEIFERT SYSTEMS WORLDWIDE PRESENCE

With our headquarters in Germany and our own subsidiaries and partners in more than 50 countries, we ensure proximity to our customers and worldwide availability of our products.

The latest additions to our distribution network are sales offices in Italy, 2019, in France, 2021 and Scandinavia, 2022.

Our subsidiary in Austria, founded in 2020, together with Seifert Systems AG in Switzerland complete our strategic concept for the DACH region (GER, AUT, CH).

Seifert USA is located in Rhode Island on the East Coast and supplies the entire continent from there. The factory site was expanded in 2020 and ensures both production close to the market and storage capacity. Both shorten our delivery times and create capacity in our plants in Europe.

Beyond Seifert USA, we have a solid network of partners throughout North and South America to provide support and service for our products.

In Asia our customers are also looked after individually by both our own staff and partner companies. We maintain long-term service and storage concepts for customer projects throughout the APAC region (Asian Pacific).

Seifert Australia is already our second-generation mainstay on the continent. The local branch has been serving Australia and the South Pacific region with selected service partners for more than 20 years.

All contact persons' details for the individual locations can be found on our website at <https://www.seifertsystems.com/en/about-seifert/find-us-worldwide/>

YOUR CONTACT FOR AIR CONDITIONING SOLUTIONS

We ventilate, cool, dehumidify, heat, regulate and illuminate enclosures and control cabinets in mechanical engineering, telecoms, medical technology and the food and automotive industries.



ENCLOSURE CONSTRUCTION

Industrial enclosures have electrical and electronic components inside which are not located directly in the machine. The components installed in the enclosure or cabinet must be protected from dust, humidity and strong temperature fluctuations.



MACHINE AND PLANT ENGINEERING

We accompany our customers from the development of their machines and plants up to their production. The right air conditioning creates the necessary environmental conditions and increases the efficiency, reliability and sustainability of the machine.



TELECOMMUNICATIONS / DATA TECHNOLOGY

For the cooling of telecommunication equipment, we develop hard-wearing solutions which are exposed to special environmental conditions such as wind, weather and fluctuating temperatures. Our air / water heat exchangers guarantee stable heat dissipation and are also suitable for use in data centres and server rooms.



ENVIRONMENTAL ENGINEERING

Air, water, soil and the climate form the natural basis of our lives. Environmental technology already begins in the production process. We cool in water treatment plants, in heat recovery and in analysis technology.

RENEWABLE ENERGY

Solar and wind energy are among the most important power sources of the future. The cooling of their electronics is guaranteed with the help of our various cooling solutions, even in constantly changing weather conditions.



FOOD PROCESSING INDUSTRY

Millions of bottles, cans and PET containers are filled and packed in bottling plants. Seifert Systems offers innovative cooling solutions for this market and masters the special hygiene requirements of the food processing industry.



LASER / ADDITIVE MANUFACTURING

Additive manufacturing processes have now developed into a new industry. The high demands on computing power as well as motion and process control require stability and reliability in their cooling. Seifert Systems meets these requirements with innovative air conditioning solutions.

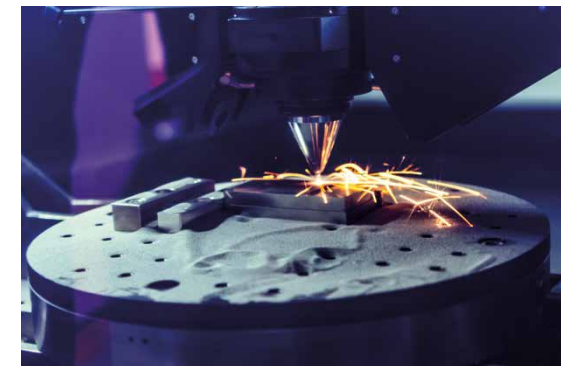

MARINE / LOGISTIC

In the navy, machines and systems are used which are exposed to special environmental conditions. High IP protection and corrosion-resistant materials are basic requirements. Special attention is paid to these requirements in our cooling solutions.



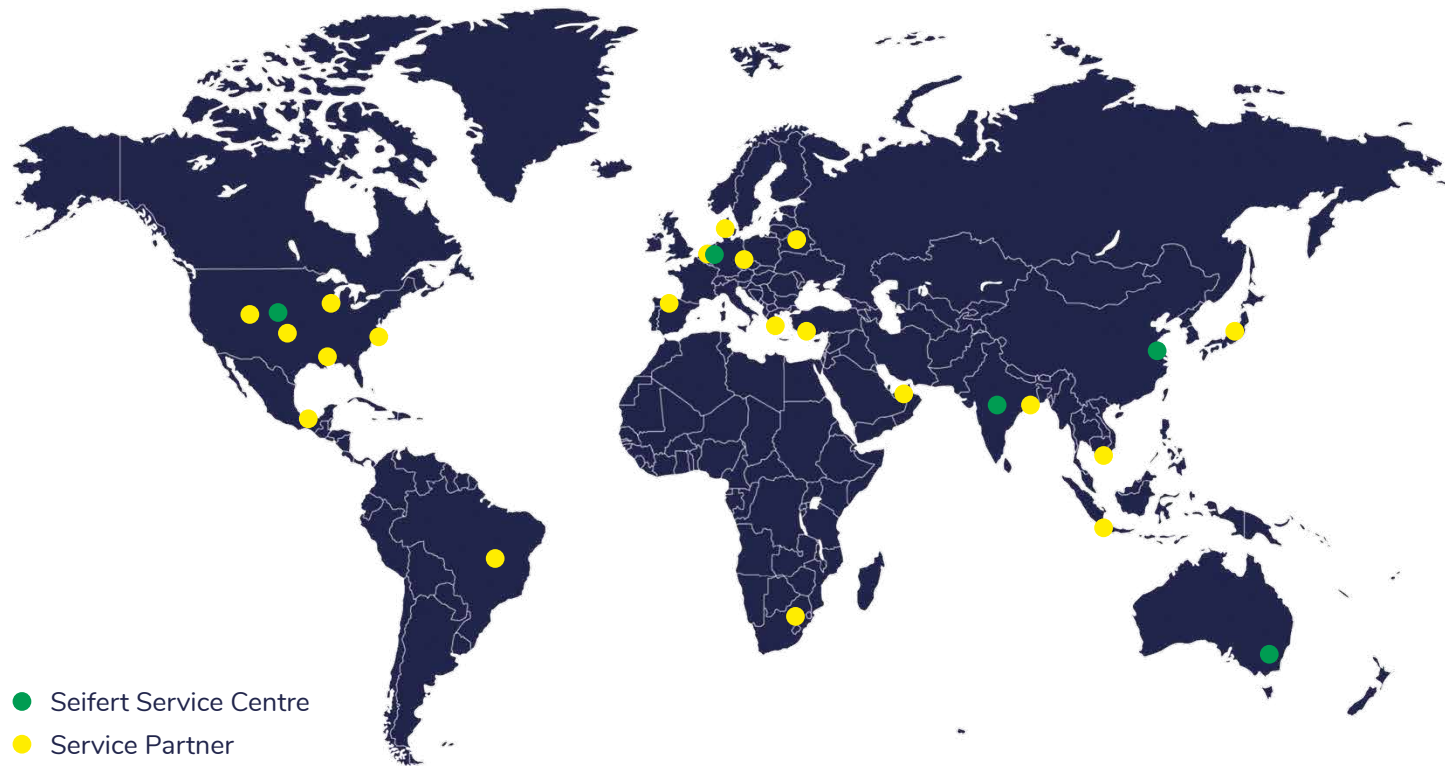

SPARE PARTS - MAINTENANCE - TRAINING

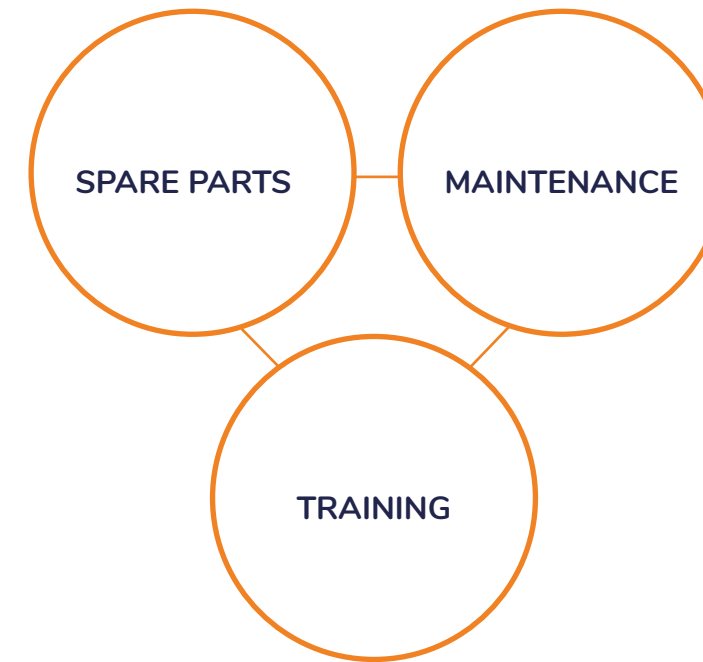

CUSTOMER-ORIENTED SERVICE FOR MINIMAL DOWNTIME

Seifert Systems offers maintenance and service for your enclosure cooling equipment.

Seifert Systems provides complete service of enclosure cooling units, heat exchangers and chillers. Our service centres for the regions Europe, Middle East Africa (EMEA), for North, Central and South America (AMER) and for the Asia Pacific region (APAC) store spare parts and replacement units and thus secure your production sites worldwide.

A further 50 authorised service partners on all continents also guarantee fast on-site assistance.

We guarantee prompt processing of every request. We offer professional maintenance and repair of your devices. We ensure that your machines and systems are operational at all times.

Or we train you ourselves.

SPARE PART MANAGEMENT

- Original spare parts from Seifert Systems
- Device specific pre-configured spare part kits
- Worldwide express shipping
- Local availability in our service centres
- Personal advice
- Professional and fast problem solving
- Minimum downtime of your machines and plants

MAINTENANCE

- Advice and review of the installation and its energy efficiency
- Overall condition assessment and visual inspection
- Functional tests of the individual components
- Leak test
- Adjusting the operating parameters
- Cleaning

TRAINING

- Training in the Seifert service centres or on your premises
- Training of your employees in the most important device functions tailored to your applications
- Safe operation from the first minute guaranteed



UNDERSTANDING CLIMATE NEUTRALITY AS A GOAL

USING CLIMATE CONDITIONS

Seifert Malta has had a photovoltaic system with a total of 3,140 panels in operation since 2016. It is one of the larger plants in Malta and generates around 1.2 GWh of electricity annually. The saving in CO₂ emissions is 860 tons per year.



SETTING AND ACHIEVING GOALS

As the first location of the group of companies, the factory in Malta manufactures completely climate-neutral. In addition, the incoming and outgoing transport of goods is optimised, every kilometre driven is questioned thus reducing CO₂ emissions to a minimum.



OUR CONTRIBUTION TOWARDS A BETTER FUTURE

We all need to pay more attention to the environment and commit to sustainability. This awareness is deeply rooted in our company philosophy.

We regularly analyse our production processes for more potential for sustainability and question our consumption of raw materials not only for cost reasons. Whenever possible we reduce it or find environmentally friendly alternatives.

We invest in new technologies, more modern and more efficient machines that help us to reduce CO₂ emissions.

In 2021 we installed the first charging stations for hybrid and electric cars on our company premises making it easier for our employees to switch to electric vehicles.

We take the goals of the Paris climate agreement seriously and have our own CO₂ emissions recorded transparently by external audits.

We are committed to further reduce our own CO₂ footprint and are also investing in selected climate protection projects. The aim is to achieve climate neutrality for all plants within the Seifert Group.

We want to actively shape our own future and that of future generations so that it is worth living in.

SEIFERT SYSTEMS IS CERTIFIED

Since 2015 we have been certified to ISO 14001:2015 environmental standards. We underline the company's commitment to protecting our environment. Our factories are committed individually and as a group to promoting environmentally friendly processes.

FIT FOR 55 PACKAGE

Following the EU's target of reducing net greenhouse gas emissions by at least 55% by 2030, we want to reduce our own CO₂ emissions reaching this ambitious target. Our goal is to consistently implement our environmental strategy at all Seifert locations.

	Model	Cooling capacity	Nominal voltage (V)						Mounting				Dimension (H x W x D) mm	Page
			230	120	400/460	12	24	48	Wall	Internal	Recess	TOP		
SLIMLINE PRO	KG 8503	350 W	•	•				•		•		600 x 250 x 135	22	
	KG 8505	550 W	•	•				•		•		370 x 520 x 155	22	
	KG 8506	670 W	•	•	•			•		•		600 x 250 x 135	22	
	KG 8508	825 W	•	•	•			•		•		950 x 305 x 210	24	
	KG 8512	1.2 kW	•	•	•			•		•		950 x 305 x 210	24	
	KG 8412	1.5 kW	•	•	•			•		•		950 x 395 x 250	24	
	KG 8515	1.5 kW	•	•	•			•		•		1,350 x 395 x 210	26	
	KG 8520	2.0 kW	•	•	•			•		•		1,350 x 395 x 210	26	
	KG 8525	2.5 kW	•	•	•			•		•		1,350 x 395 x 210	28	
	KG 8540	4.0 kW	•	•	•			•		•		1,550 x 455 x 270	28	
	KG 8562	6.2 kW	•	•	•			•		•		1,630 x 455 x 270	28	
	VARIO	KG 8625	2.5 kW	•	•				•		•		1,350 x 395 x 210	32
		KG 8650	5.0 kW	•	•				•		•		1,550 x 455 x 270	32
	SLIMLINE	KG 4266	320 W	•	•				•		•		520 x 270 x 110	38
KG 4267		400 W	•	•				•		•		340 x 520 x 110	38	
KG 4269		500 W	•	•				•		•		600 x 320 x 110	40	
KG 4271		820 W	•	•	•			•		•		980 x 395 x 145	40	
KG 4272		1.1 kW	•	•	•			•		•		1,250 x 395 x 145	42	
KG 4274		1.5 kW	•	•	•			•		•		1,550 x 395 x 145	42	
TOP		KG 4482	450 W	•	•							•	230 x 330 x 430	48
	KG 4555	1.1 kW	•	•	•						•	400 x 400 x 600	48	
COMPACT INDOOR	KG 4304	320 W	•	•	•			•				500 x 280 x 200	52	
	KG 4305	550 W	•	•	•			•	•			650 x 315 x 260	52	
	KG 4309	850 W	•	•	•			•	•			650 x 315 x 260	54	
	KG 4310	1.0 kW	•	•	•			•	•			650 x 315 x 260	54	
	KG 4315	1.5 kW	•	•	•			•	•			980 x 395 x 260	56	
	KG 4320	2.0 kW	•	•	•			•	•			980 x 395 x 260	56	
	KG 4325	2.5 kW	•	•	•			•	•			1,230 x 500 x 340	58	
	KG 4330	3.0 kW	•	•	•			•	•			1,230 x 500 x 340	58	
	KG 4340	4.0 kW	•	•	•			•	•			1,230 x 500 x 340	60	
	COMPACT OUTDOOR TYPE 4X	OC 5704	290 W	•	•				•				480 x 250 x 190	66
OC 5705		550 W	•	•	•			•				830 x 304 x 270	66	
OC 5708		750 W	•	•	•			•				830 x 304 x 270	68	
OC 5710		1.0 kW	•	•	•			•				900 x 304 x 270	68	
OC 5715		1.5 kW	•	•	•			•				1,150 x 395 x 270	70	
OC 5720		2.0 kW	•	•	•			•				1,150 x 395 x 270	70	
OC 5726		2.5 kW	•	•	•			•				1,550 x 457 x 355	72	
OC 5731		3.0 kW	•	•	•			•				1,550 x 457 x 355	72	
OC 5741		4.0 kW	•	•	•			•				1,550 x 457 x 355	74	
OC 8762		6.2 kW	•	•	•			•				1,135 x 455 x 390	74	
PROTEC		OC 8706	600 W	•	•	•			•				380 x 250 x 250	78
		OC 8712	1.2 kW	•	•	•			•				585 x 305 x 305	78
		OC 8720	2.0 kW	•	•	•			•				890 x 395 x 305	80
	OC 8740	4.0 kW	•	•	•			•				1,040 x 455 x 370	80	
	OC 8762	6.2 kW	•	•	•			•				1,135 x 455 x 390	80	
Thermoelectric / PELTIER	TG 3030/35 ¹⁾	30 W				•	• ¹⁾	•	•			110 x 154 x 125(29) ¹⁾	84	
	TG 3050	50 W					•	•	•			206 x 154 x 139	86	
	TG 3075	75 W					•	•	•			250 x 203 x 154	86	
	TG 3102	100 W					•	•	•			200 x 304 x 139	86	
	TG 3155	150 W					•	•	•			306 x 203 x 160	88	
	TG 3152/200	150 W / 200 W ¹⁾					•	• ¹⁾	•	•		400 x 180 x 170	88	
	TG 6105	100 W	•	•				•	•			280 x 350 x 164	90	
	TG 6155	150 W	•	•				•	•			500 x 330 x 190	90	
	TG 6205	200 W	•	•				•	•			500 x 330 x 190	90	
	TG 6405	400 W	•	•				•	•			600 x 432 x 199	92	
	TG 6805	800 W	•	•				•	•			972 x 514 x 211	92	
	TG 3152 EX	150 W						•	•			405 x 185 x 165	94	
	TG 3039	Thermoelectric dehumidifier						•					136 x 176 x 133	96

	Model	Cooling capacity	Nominal voltage (V)						Mounting					Dimension (H x W x D) mm	Page	
			230	120	400/460	24	48	Wall	Internal	Recess	TOP	19"	DIN			
19" rack units	KG 4533	550 W	•	•	•							•		222 (5HE) x 483 x 549	102	
	KG 4534	850 W	•	•	•							•		266 (6HE) x 483 x 549	102	
	KG 4535	900 W	•	•	•							•		266 (6HE) x 483 x 549	102	
	RK 2192	1.0 kW	•	•								•		89 (2HE) x 443 x 408	104	
	RK 2194	2.0 kW	•	•								•		178 (4HE) x 443 x 505	104	
	RK 2197	2.1 kW	•	•								•		178 (4HE) x 443 x 544	104	
	Air / water heat exchangers	RK 7506	750 W	•	•			•							600 x 250 x 127	108
		RK 7306	750 W	•	•			•							370 x 520 x 131	110
		RK 7512	1.1 kW	•	•	•									950 x 305 x 192	112
		RK 7525	2.4 kW	•	•	•									1,350 x 395 x 192	114
		RK 7555	5.5 kW	•	•	•									1,550 x 455 x 232	116
		RK 2300	350 W	•	•			•		•	•				303 x 153 x 84	120
		RK 2114	650 W	•	•					•					400 x 212 x 80	122
		RK 2114	700 W	•	•	•	•	•		•					632 x 212 x 80	123
RK 2114		1.2 kW	•	•	•				•	•				891 x 212 x 80	124	
RK 2100		1.3 kW	•	•	•				•	•				525 x 303 x 136	124	
RK 2120		2.0 kW	•	•	•				•					950 x 400 x 180	124	
RK 2130		3.1 kW	•	•	•				•					950 x 400 x 180	126	
RK 2149		4.8 kW	•	•	•				•					1,400 x 460 x 242	126	
Chiller overview													128			
Air / air heat exchangers	LT 58007	7 W/K	•	•					•					508 x 196.5 x 152	134	
	LT 58014	14 W/K	•	•					•					749 x 254 x 151	134	
	LT 58032	32 W/K	•	•					•					750 x 254 x 151	136	
	LT 58043	43 W/K	•	•					•					1,194 x 254 x 151.3	136	
	LT 58065	65 W/K	•	•					•					914.4 x 460 x 173	138	
	LT 58100	100 W/K	•	•					•					914.4 x 460 x 218	138	
	LT 58180	180 W/K	•	•					•					1,524 x 609.6 x 356	138	
Enclosure accessories																
Filter fans / exhaust filters	Exhaust filters FF 4000 / 4000E								•					106.5 x 106.5 x 23.2	142	
	FL 4010A, FL 4023A	•	•						•			12 / 22 m³/h		106.5 x 106.5 x 66.6	144	
	FL 4210A, FL 4210D	•	•				•	•	•			67 m³/h		150 x 150 x 73	146	
	FL 4421A	•	•						•			110 m³/h		204 x 204 x 95.5	148	
	FL 4610D						•	•	•			225 m³/h		250 x 250 x 124.2	148	
	FL 4620A, FL 4621A	•	•						•			230 / 105 m³/h		250 x 250 x 124.2	150	
	FL 4830A	•	•	•					•			455 m³/h		325 x 325 x 160.2	152	
	FL 4883A	•	•	•					•			820 m³/h		325 x 325 x 158.5	152	
	FL 6064A, FL 6065A	•										275 / 490 m³/h	•	147 x 457 x 457	154	
	FL 6085A, FL 6095A	•		•								630 / 970 m³/h	•	147 x 457 x 457	156	
FL 6995A, FL 6997A	•		•								1400 / 1500 m³/h	•	230 x 528 x 528	158		
FC 4000 Protection hood for filter fans																
Heater / Fan heater	KH 401 - 350 W	•	•										•	79 x 54 x 92	164	
	KH 501 - 25 / 50 W	•	•										•	125 x 41 x 41	166	
	KH 501 - 75 / 100 W	•	•										•	140 x 70 x 63	166	
	KH 501 - 150 W	•	•										•	220 x 59 x 61	166	
	KH 503 - 250 W	•	•										•	135 x 82 x 112	167	
	KH 503 - 400 / 500 W	•	•										•	165 x 82 x 112	167	
	KH 503 - 750 W	•	•										•	225 x 82 x 112	167	
	KH 801 - 125 / 200 W	•	•						•				•	137 x 111 x 116	168	
	KH 801 - 400 / 800 W	•	•										•	190 x 111 x 116	169	
	KH 801 - 1300 W	•	•										•	190 x 126 x 155	169	
Controls	CC 3010 Thermostat	•											•	60 x 39 x 42.4	172	
	CC 3011 Thermostat	•											•	60 x 39 x 42.4	173	
	CC 3012/13 Thermostat	•									•		•	60 x 72.3 x 42.4	174	
	CC 3014 Hygrostat	•											•	60 x 39 x 42.4	174	
	CC 3015 Thermostat	•											•	60 x 39 x 53.3	175	
	CC 3016 Hygrostat	•									•		•	60 x 39 x 53.3	175	
	LED	LED lamp 400 / 700 lm	•	•										•	357.4 x 32 x 35.5	178
LED lamp 1500 Lm		•	•								•			420 x 90 x 45	180	

ENCLOSURE COOLING WITH A MODERN INDUSTRIAL DESIGN

SLIMLINE PRO



MICROCHANNEL CONDENSER
ALLOWS 50% LESS REFRIGERANT
CHARGE AND HIGHER EFFICIENCY

PROTECTION CLASS IP 55
IN STAINLESS STEEL IP 56 / TYPE 4X

TEMPERATURE RANGE 10°C - 60°C



MODERN INDUSTRIAL DESIGN

CONTROLLER WITH DISPLAY

CONDENSATE EVAPORATOR IN
V2A STAINLESS STEEL

SLIMLINE PRO ENCLOSURE COOLING UNITS

The new mounting system allows a quick and easy installation thanks to simplified enclosure cutouts.

SLIMLINE PRO cooling units can be either wall mounted or semi recessed.

They cover a wide range of industrial cooling applications for machines and plants. Multiple cooling capacities with just one cutout simplify the inventory of cooling units and spare parts.

Various stainless steel grades are available for applications where hygiene or high corrosion protection are important.

SLIMLINE PRO enclosure cooling units are cutout compatible with our SLIMLINE HEX air / water heat exchanger series 7500.

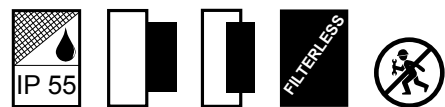



SLIMLINE PRO

Enclosure cooling with a new design

KG 8503 - KG 8505 - KG 8506

- ✓ Cooling capacities: 350 W, 550 W and 670 W
- ✓ Microchannel condenser allows significant reduction in refrigerant charge resulting in a lower CO₂ equivalent
- ✓ Built in electrical condensate evaporation
- ✓ Enhanced protection class of IP 55 / UL Type 12
- ✓ UL Type 4X with stainless steel housing
- ✓ Temperature range 10°C - 60°C
- ✓ Noise reduced versions available on request
- ✓ Cutout compatible with SLIMLINE HEX air / water heat exchanger RK 7306 and RK 7506 (pages 108, 110)

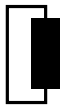
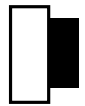

Model	KG 8503		KG 8505		KG 8506		
Order number	850300001	850310001	850500001	850510001	850600001	850610001	850620001
Order no. in stainless steel 304 (V2A)	85XX00S62						
Cooling capacity L35L35 ²⁾	350 / 350 W		650 / 700 W		670 / 680 W		700 / 750 W
Cooling capacity L35L50 ²⁾	200 / 215 W		460 / 490 W		435 / 450 W		510 / 535 W
Compressor type	Rotary piston						
Operating temperature range	10°C - 60°C ¹⁾						
Setting range	25°C - 50°C						
System air flow ³⁾	200 / 122 m ³ /h				225 / 122 m ³ /h		
Unimpeded air flow ³⁾	408 / 180 m ³ /h				408 / 180 m ³ /h		
Mounting	Wall mounted / recessed						
Dimensions A x B x C (D+E) mm	600 x 250 x 135 (45+90)		370 x 520 x 155 (60+95)		600 x 250 x 135 (45+90)		600 x 250 x 187.6 (48.6+139)
Housing material / colour	Mild steel powder coated / RAL 7035						
Weight	13.7 kg		16 kg		14 kg		16 kg
ELECTRICAL DATA							
Voltage / Frequency	230 V ~ 50/60 Hz	120 V ~ 50/60 Hz	230 V ~ 50/60 Hz	120 V ~ 50/60 Hz	230 V ~ 50/60 Hz	120 V ~ 50/60 Hz	400 / 460 V 50/60 Hz 2~
Current L35L35 ²⁾	1.5 / 1.3 A	2.4 / 2.2 A	1.9 / 1.8 A	4.7 / 3.7 A	2 / 1.9 A	5.6 / 4.1 A	1.1 / 0.9 A
Starting current	4 A	7.5 A	6 A	13 A	6 A	13 A	3.0 A
Max. current	1.6 A	2.7 A	2.5 A	4.8 A	2.7 A	6.0 A	1.3 A
Nominal power L35L35 ²⁾	300 / 300 W	250 / 240 W	390 / 450 W	435 / 405 W	410 / 430 W	515 / 455 W	410 / 415 W
Max. power	355 W	300 W	570 W	580 W	620 W		585 W
Fuse rating	15 A (T)						
Connection	4 - pole connector for power, 5 - pole connector for signals						
Ingress protection	IP 55 / Type 12 (with gasket kit expandable to Type 3, 3R, 4) IP 56 / Type 4X for stainless steel models						
Certification	CE. cURus. cULus						

¹⁾ Operating temperature range according to UL 10°C - 55°C

²⁾ Values for 50/60 Hz

³⁾ Ambient / enclosure

Filter options, cold air outlet ducts, anti vibration & gasket kits and other accessories on page 34

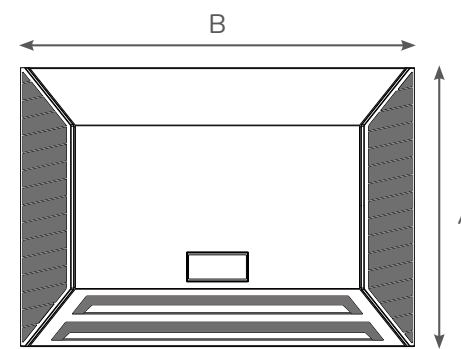
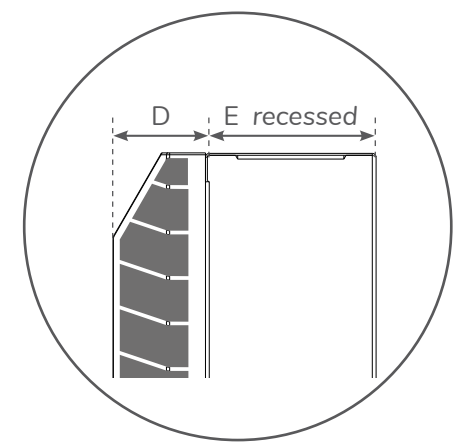
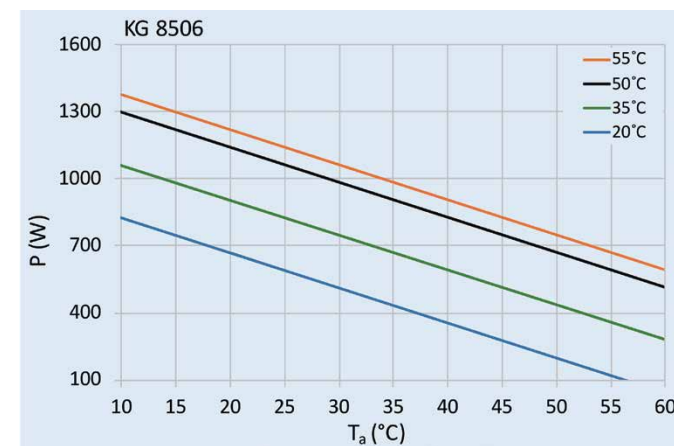
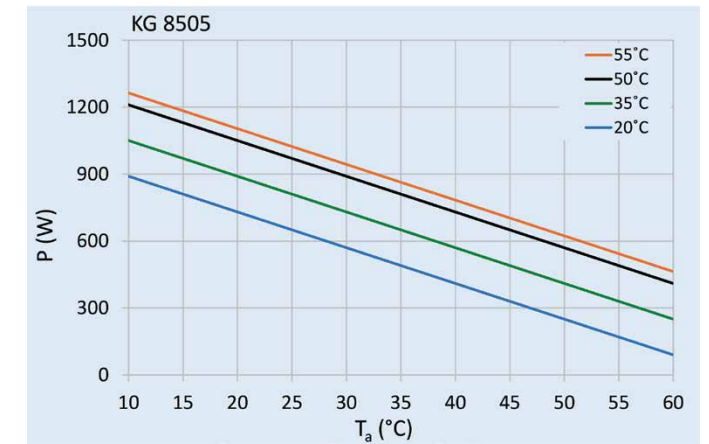
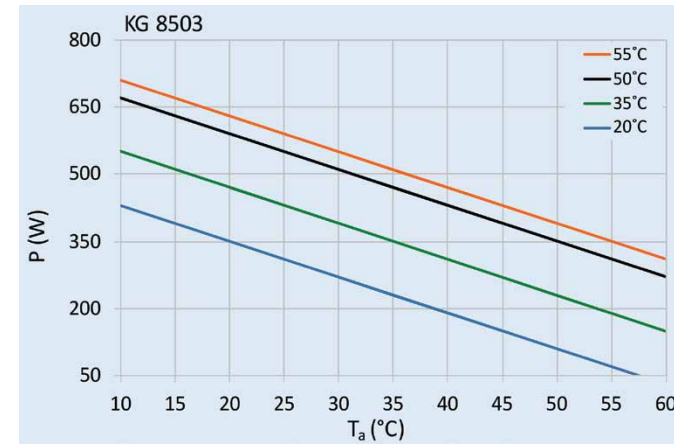

KG 8505

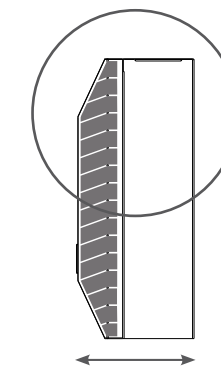

C wall mounted

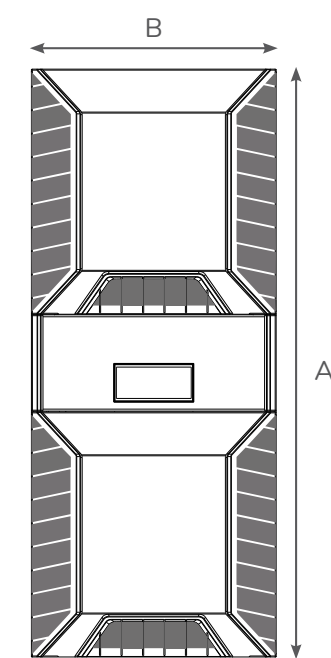

KG 8503 / 06

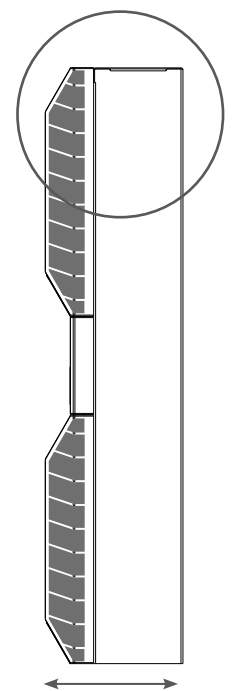

C wall mounted

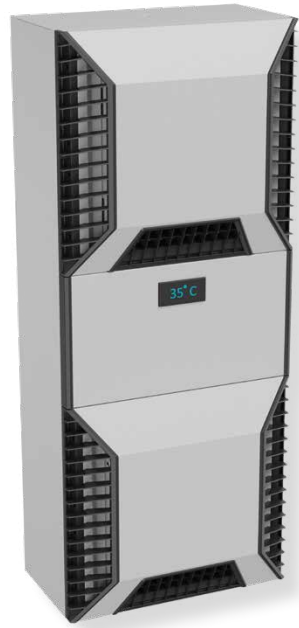

SLIMLINE PRO

Enclosure cooling with a new design

KG 8508 - KG 8512 - KG 8412

- ✓ Cooling capacities: 825 W, 1.2 kW and 1.5 kW
- ✓ Microchannel condenser allows significant reduction in refrigerant charge resulting in a lower CO₂ equivalent
- ✓ Built in electrical condensate evaporation
- ✓ Enhanced protection class of IP 55 / UL Type 12
- ✓ UL Type 4X with stainless steel housing
- ✓ Temperature range 10°C - 60°C
- ✓ Cutout compatible with SLIMLINE HEX air / water heat exchanger RK 7512 (page 112)

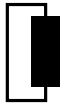

Model	KG 8508			KG 8512			KG 8412				
Order number	850800001	850810001	850820001	851200001	851210001	851220001	841200001	841210001	841220001		
Order no. stainless steel 304	85XX00S62 / 84XX00S62										
Cooling capacity L35L35 ²⁾	825 / 870 W			1.20 / 1.20 kW			1.20 / 1.26 kW			1.50 / 1.55 kW	
Cooling capacity L35L50 ²⁾	820 / 835 W			900 / 900 W			900 / 1.0 kW			1.27 / 1.33 kW	
Compressor type	Rotary piston										
Operating temperature range	10°C - 60°C ¹⁾			10°C - 60°C							
Setting range	20°C - 50°C										
System air flow ³⁾	370 / 350 m ³ /h			300 / 350 m ³ /h			550 / 350 m ³ /h			550 / 350 m ³ /h	
Unimpeded air flow ³⁾	650 / 550 m ³ /h			550 / 550 m ³ /h			850 / 850 m ³ /h			850 / 850 m ³ /h	
Mounting	Wall mounted / recessed										
Dimensions A x B x C (D+E)	950 x 305 x 210 (55+155) mm						950 x 395 x 250 (55+195) mm				
Housing material / colour	Mild steel powder coated / RAL 7035										
Weight	25.2 kg	30 kg	30 kg	33.5 kg	33 kg	38.5 kg	45 kg	40 kg			
ELECTRICAL DATA											
Voltage / Frequency	230 V ~ 50/60 Hz	120 V ~ 50/60 Hz	400 / 460 V 50/60 Hz 2~	230 V ~ 50/60 Hz	120 V ~ 50/60 Hz	380-415V 50Hz 3~ 400-460V 60Hz 3~	230 V ~ 50/60 Hz	120 V ~ 50/60 Hz	380-415V 50Hz 3~ 400-460V 60Hz 3~		
Current L35L35 ²⁾	2.1 / 2.3 A	4.2 / 4.6 A	1.2 / 1.15 A	3.3 / 3.6 A	6.6 / 7.2 A	1.6 A	3.2 / 3.6 A	6.4 / 7.2 A	1.7 A		
Starting current	6 A	28 A	4.0 A	15 A	30 A	8.2 A	16 A	32 A	8.2 A		
Max. current	3 A	6.8 A	1.7 A	5 A	10 A	2.0 A	4.7 A	9.4 A	2.0 A		
Nominal power L35L35 ²⁾	460 / 520 W			715 / 830 W			700 / 875 W			680 / 830 W	
Max. power	690 W			1.15 kW			1.2 kW			1.1 kW	
Fuse rating	15 A (T)										
Connection	4 - pole connector for power, 5 - pole connector for signals										
Ingress protection	IP 55 / Type 12 (with gasket kit expandable to Type 3, 3R, 4) IP 56 / Type 4X for stainless steel models										
Certification	CE, cURus, cULus										

¹⁾ Operating temperature range according to UL 10°C - 55°C

²⁾ Values for 50/60 Hz

³⁾ Ambient / enclosure

Filter options, cold air outlet ducts, anti vibration & gasket kits and other accessories on page 34

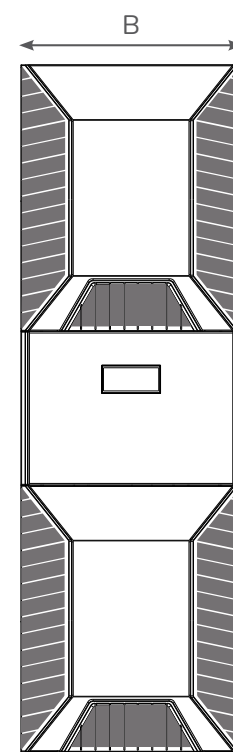
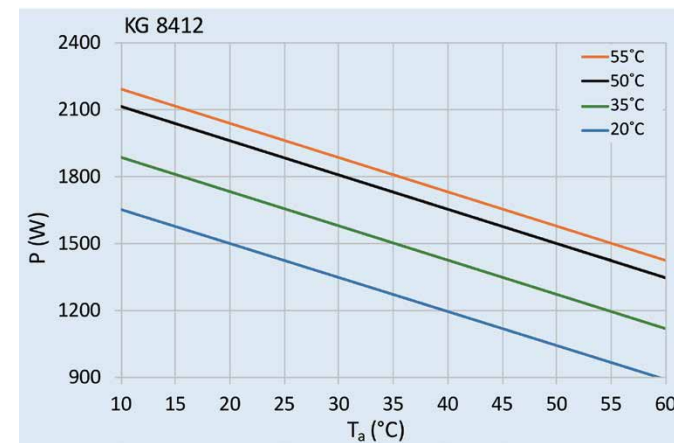
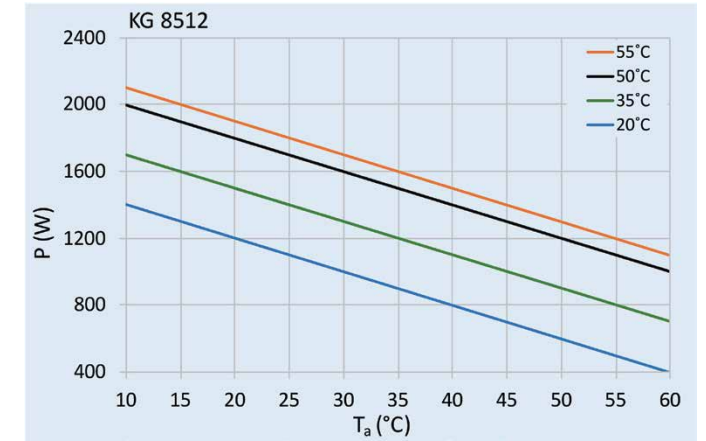
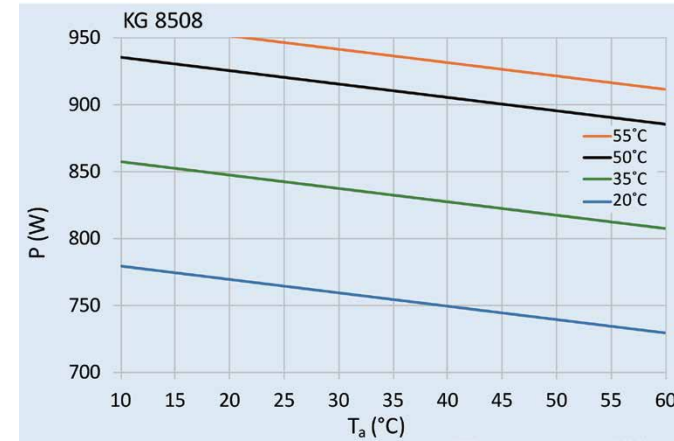

KG 8508 / 12 / 8412

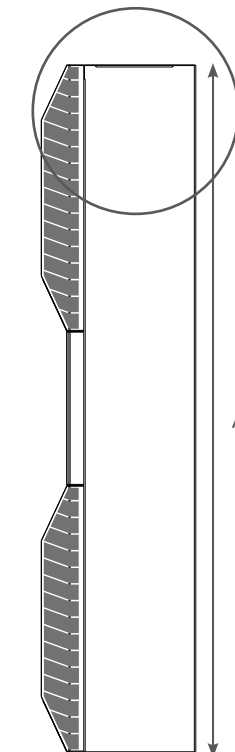

C wall mounted

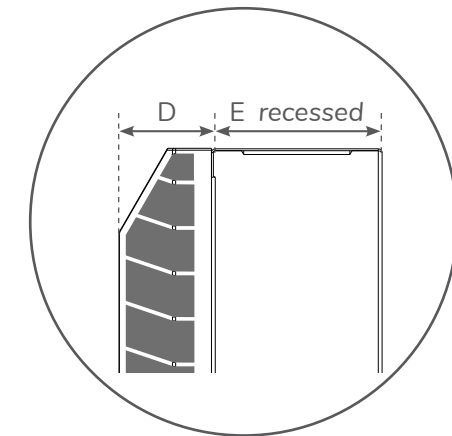



SLIMLINE PRO

Enclosure cooling with a new design

KG 8515 - KG 8520

- ✓ Cooling capacities: 1.5 kW and 2 kW
- ✓ Microchannel condenser allows significant reduction in refrigerant charge resulting in a lower CO₂ equivalent
- ✓ Built in electrical condensate evaporation
- ✓ Enhanced protection class of IP 55 / UL Type 12
- ✓ UL Type 4X with stainless steel housing
- ✓ Temperature range 10°C - 60°C
- ✓ Cutout compatible with SLIMLINE HEX air / water heat exchanger RK 7525 (page 114)

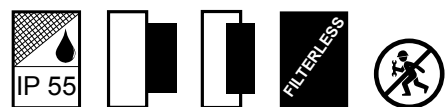

Model	KG 8515			KG 8520		
	Order number	851500001	851510001	851520001	852000001	852010001
Order no. in stainless steel 304 (V2A)	85XX00S62					
Cooling capacity L35L35 ¹⁾	1.5 / 1.5 kW			2.0 / 2.1 kW		2.0 / 2.0 kW
Cooling capacity L35L50 ¹⁾	1.3 / 1.3 kW			1.85 / 1.85 kW		1.7 / 1.75 kW
Compressor type	Rotary piston					
Operating temperature range	10°C - 60°C					
Setting range	20°C - 50°C					
System air flow ²⁾	550 / 500 m ³ /h			680 / 500 m ³ /h		680 / 500 m ³ /h
Unimpeded air flow ²⁾	850 / 850 m ³ /h			1,200 / 850 m ³ /h		1,200 / 850 m ³ /h
Mounting	Wall mounted / recessed					
Dimensions A x B x C (D+E) mm	1,350 x 395 x 210 (55+155) mm					
Housing material / colour	Mild steel powder coated / RAL 7035					
Weight	41 kg	44 kg		46.2 kg	49.5 kg	48.7 kg
ELECTRICAL DATA						
Voltage / Frequency	230 V ~ 50/60 Hz	120 V ~ 50/60 Hz	380-415V 50Hz 3~ 400-460V 60Hz 3~	230 V ~ 50/60 Hz	120 V ~ 50/60 Hz	380-415V 50Hz 3~ 400-460V 60Hz 3~
Current L35L35 ¹⁾	3.2 / 3.5 A	6.1 / 6.7 A	1.5 / 1.6 A	4.4 / 5.6 A	8.8 / 11.2 A	1.9 / 2 A
Starting current	16 A	32 A	8.2 A	16 A	32 A	16 A
Max. current	4.7 A	9.5 A	2 A	7.4 A	14.8 A	2.9 A
Nominal power L35L35 ¹⁾	715 / 830 W		710 / 890 W	1.0 / 1.25 kW	1.0 / 1.25 kW	0.97 / 1.25 kW
Max. power	1.1 kW		1.2 kW	1.75 kW	1.75 kW	
Fuse rating	15 A (T)			20 A (T)		15 A (T)
Connection	4 - pole connector for power, 5 - pole connector for signals					
Ingress protection	IP 55 / Type 12 (with gasket kit expandable to Type 3, 3R, 4) IP 56 / Type 4X for stainless steel models					
Certification	CE, cURus, cULus					

¹⁾ Values for 50/60 Hz

²⁾ Ambient / enclosure

Filter options, cold air outlet ducts, anti vibration & gasket kits and other accessories on page 34

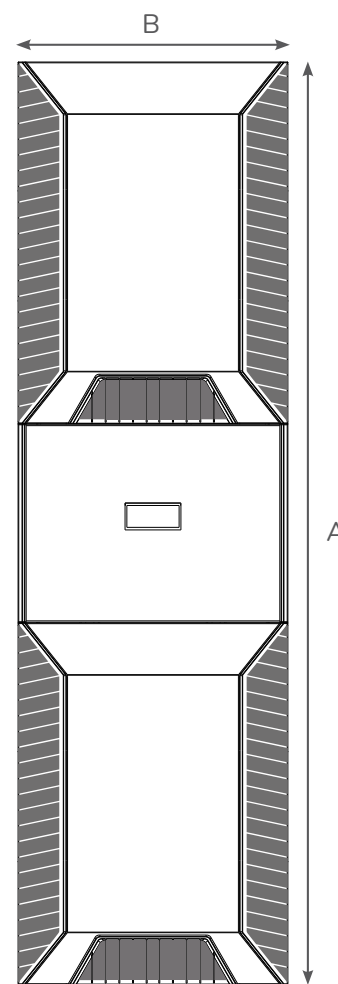
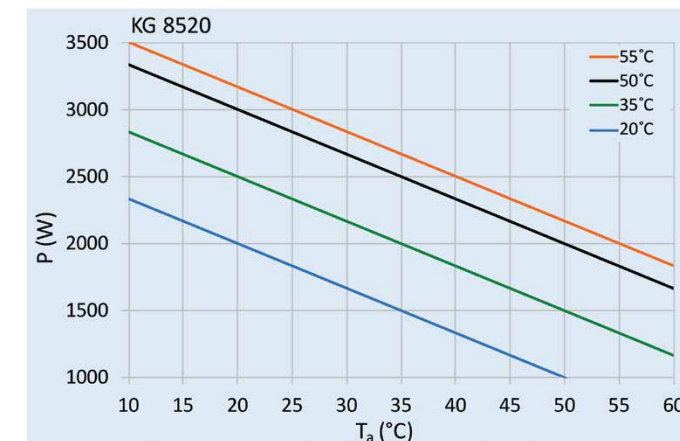
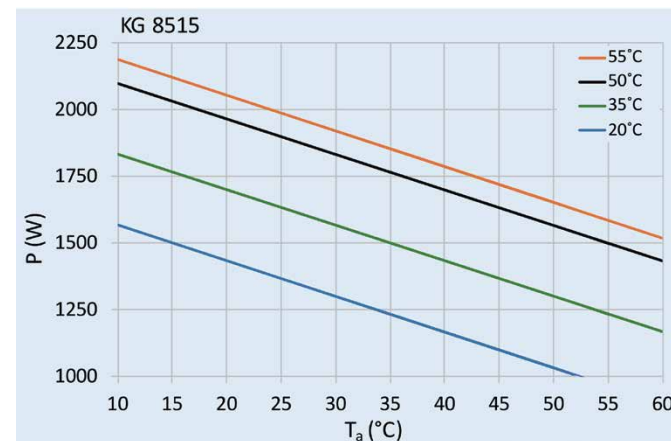

KG 8515 / 20

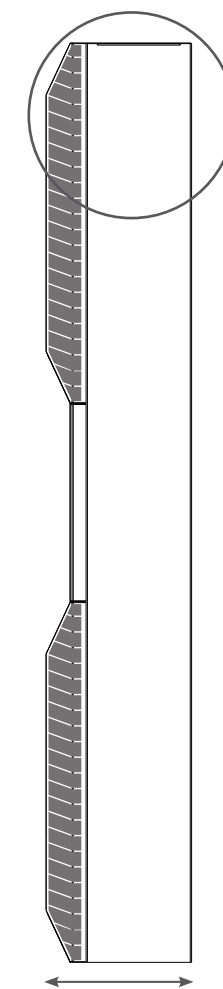

C wall mounted

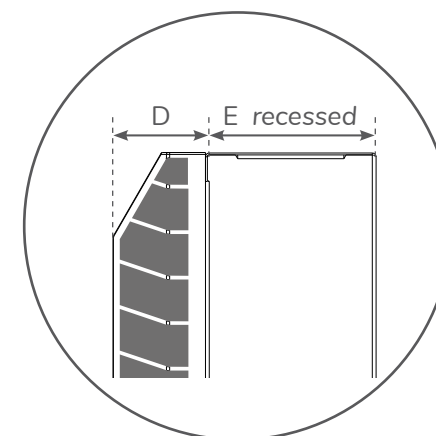

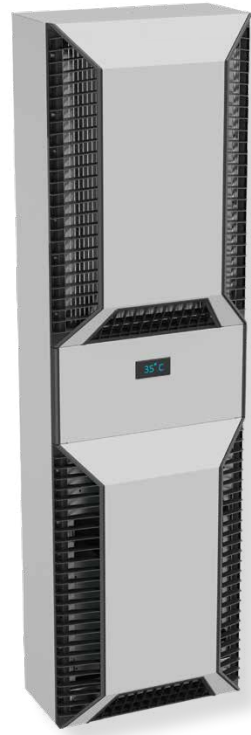

SLIMLINE PRO

Enclosure cooling with a new design

KG 8525 - KG 8540 - KG 8562

- ✓ Cooling capacities: 2.5 kW, 4 kW and 6 kW
- ✓ Microchannel condenser allows significant reduction in refrigerant charge resulting in a lower CO₂ equivalent
- ✓ Built in electrical condensate evaporation
- ✓ Enhanced protection class of IP 55 / UL Type 12
- ✓ UL Type 4X with stainless steel housing
- ✓ Temperature range 10°C - 60°C
- ✓ Cutout compatible with SLIMLINE HEX air / water heat exchanger RK 7525 and RK 7555 (pages 114, 116)

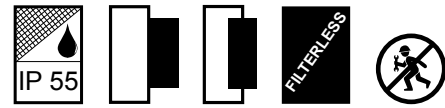

Model	KG 8525			KG 8540		KG 8562
Order number	852500001	852510001	852520001	854000001	854020001	856220001
Order no. in stainless steel 304 (V2A)	85XX00S62					
Cooling capacity L35L35 ¹⁾	2.5 / 2.5 kW			4.0 / 4.2 kW		6.0 / 6.2 kW
Cooling capacity L35L50 ¹⁾	2.1 / 2.1 kW			3.5 / 3.9 kW		5.0 / 5.5 kW
Compressor type	Rotary piston					Scroll
Operating temperature range	10°C - 60°C					10°C - 55°C
Setting range	20°C - 50°C					10°C - 50°C
System air flow ²⁾	680 / 500 m ³ /h			1,000 / 750 m ³ /h		1,050 / 1,400 m ³ /h
Unimpeded air flow ²⁾	1,200 / 850 m ³ /h			1,400 / 1,200 m ³ /h		1,000 / 1,400 m ³ /h
Mounting	Wall mounted / recessed					
Dimensions A x B x C (D+E) mm	1,350 x 395 x 210 (55+155)			1,550 x 455 x 270 (75+195)		1,630 x 455 x 270 (75+195) mm
Housing material / colour	Mild steel powder coated / RAL 7035					
Weight	47 kg	46.5 kg	45 kg	62 kg	86.5 kg	
ELECTRICAL DATA						
Voltage / Frequency	230 V ~ 50/60 Hz	120 V ~ 50/60 Hz	380-415V 50Hz 3~ 400-460V 60 Hz 3~	230 V ~ 50/60 Hz	380-415V 50Hz 3~ 400-460V 60 Hz 3~	380-415V 50Hz 3~ 400-460V 60 Hz 3~
Current L35L35 ¹⁾	5.4 / 6.6 A	10.8 / 13.2 A	2.7 / 2.7 A	8.5 / 11 A	3.5 / 3.7 A	6.2 / 6.3 A
Starting current	22.5 A	11 A	20 A	50 A	15 A	52 A
Max. current	8.5 A	19.3 A	3.1 A	14.8 A	4.8 A	10.5 A
Nominal power L35L35 ¹⁾	1.2 / 1.47 kW			1.9 / 2.5 kW	1.73 / 2.27 kW	3.1 / 3.9 kW
Max. power	1.95 kW			3.4 kW	3.2 kW	7.0 kW
Fuse rating	15 A (T)	25 A (T)	15 A (T)	20 A (T)	15 A (T)	
Connection	4 - pole connector for power, 5 - pole connector for signals					
Ingress protection	IP 55 / Type 12 (with gasket kit expandable to Type 3, 3R, 4) IP 56 / Type 4X for stainless steel models					
Certification	CE, cURus, cULus					

¹⁾ Values for 50/60 Hz

²⁾ Ambient / enclosure

Filter options, cold air outlet ducts, anti vibration & gasket kits and other accessories on page 34

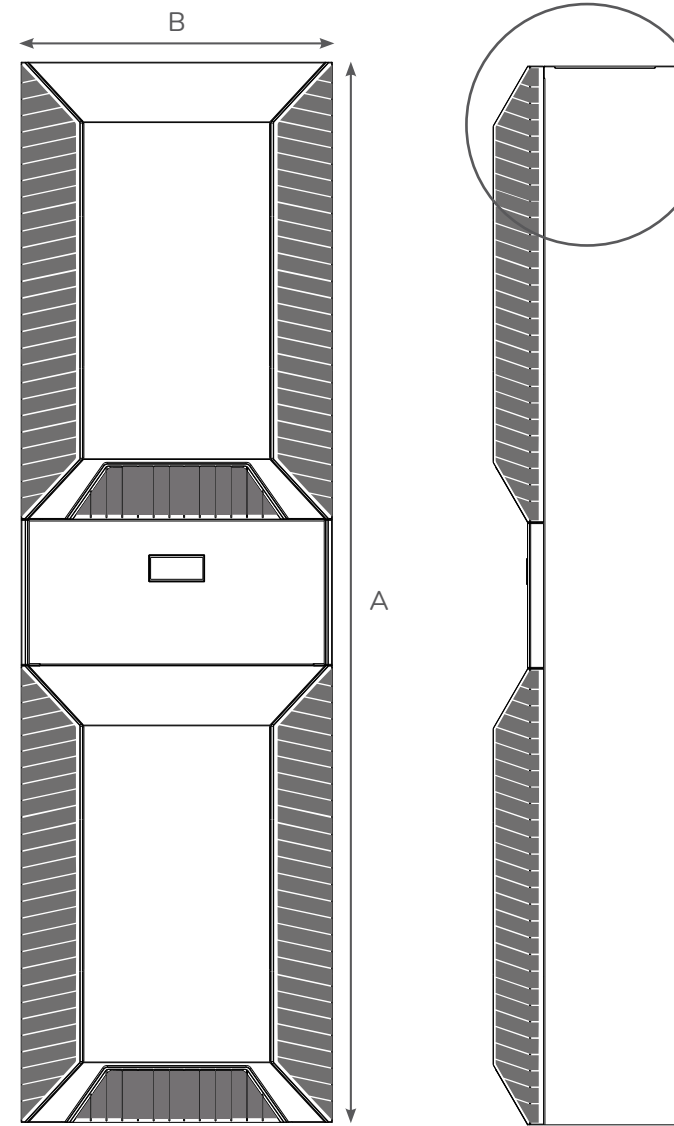
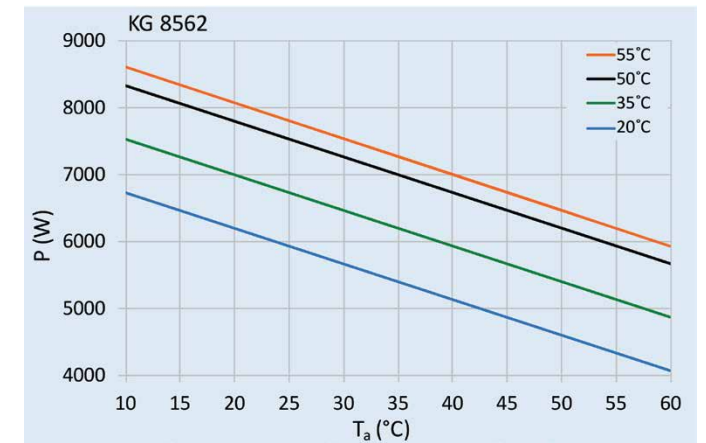
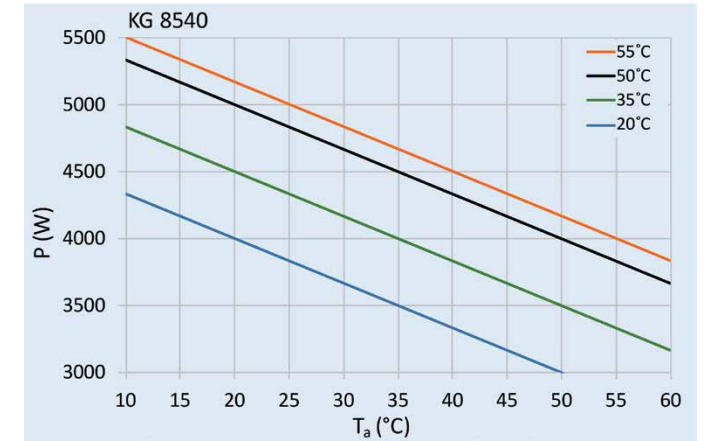
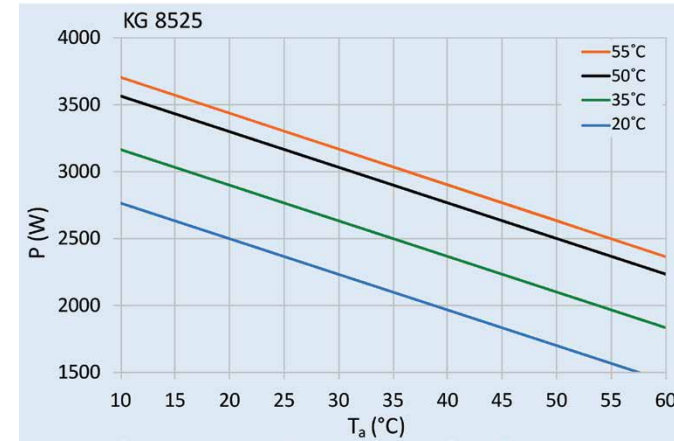

KG 8525 / 40 / 62

C wall mounted

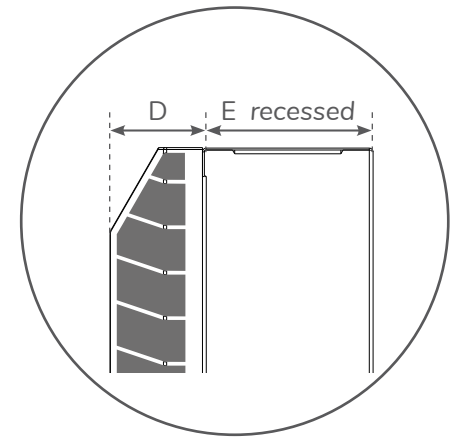

VARIABLE COOLING CAPACITY RESULTS IN ENERGY SAVINGS OF UP TO 76%

SLIMLINE VARIO



MICROCHANNEL CONDENSER
ALLOWS 50% LESS REFRIGERANT
CHARGE AND HIGH EFFICIENCY

TEMPERATURE RANGE 10°C - 60°C

VARIABLE SPEED COMPRESSOR
ALLOWS UP TO 76% ENERGY
SAVINGS

MODERN INDUSTRIAL DESIGN

CONTROLLER WITH DISPLAY

CONDENSATE EVAPORATOR IN
V2A STAINLESS STEEL

VARIABLE COOLING CAPACITY FOR CONSTANT TEMPERATURE

The continuous adjustment of the cooling capacity achieves a very constant enclosure temperature. The electronic components and the cooling unit are significantly less stressed.

The energy consumption is thus limited to the amount needed to dissipate the current power loss.

Compared to conventional cooling units, SLIMLINE VARIO units can realise energy savings of up to 76% depending on the ambient and selected target temperature.

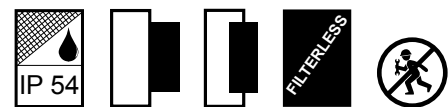

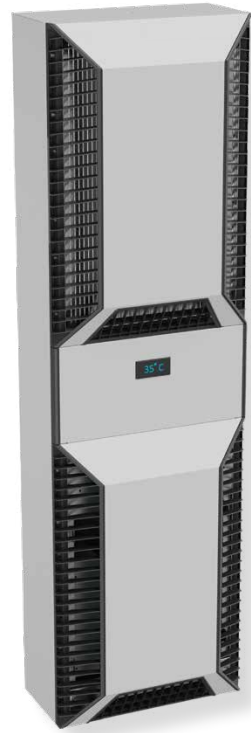

SLIMLINE VARIO

Variable cooling capacity for high energy efficiency

KG 8625 - KG 8650

- ✓ Variable cooling capacity from 500 W up to 5 kW
- ✓ Microchannel condenser allows significant reduction in refrigerant charge resulting in a lower CO₂ equivalent
- ✓ Built in electrical condensate evaporation
- ✓ Temperature range 10°C - 60°C
- ✓ With RS 485 MODBUS interface
- ✓ Cutout compatible with SLIMLINE HEX air / water heat exchanger RK 7525 and RK 7555 (pages 114 / 116)

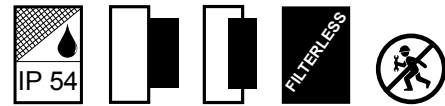

Model	KG 8625	KG 8650
Order number	862504001	865004001
Order no. in stainless steel 304 (V2A)	862504S62	865004S62
Variable cooling range	500 W - 2.55 kW	2 kW - 5 kW
Cooling capacity L35L35	2.55 kW	5.0 kW
Cooling capacity L35L50	2.16 kW	3.8 kW
Compressor type	BLDC Rotary piston	
Operating temperature range	10°C - 60°C	
Setting range	20°C - 50°C	
System air flow ¹⁾	680 / 500 m ³ /h	970 / 1,400 m ³ /h
Unimpeded air flow ¹⁾	1,200 / 850 m ³ /h	1,000 / 1400 m ³ /h
Mounting	Wall mounted / recessed	
Dimensions A x B x C (D+E)	1,350 x 395 x 210 (55+155) mm	1,550 x 455 x 270 (75+195) mm
Housing material / colour	Mild steel powder coated / RAL 7035	
Weight	45 kg	62 kg
ELECTRICAL DATA		
Voltage / Frequency	115-250 V ~ 50/60 Hz	230 V ~ 50/60 Hz
Current L35L35 ²⁾	9.2 / 4.6 A	10.5 / 11.1 A
Starting current ²⁾	16 / 8 A	10.5 A
Max. current ¹⁾	12.6 / 6.3 A	14.8 A
Nominal power L35L35 ²⁾	1.02 kW	2.4 / 2.5 kW
Max. power	1.42 kW	2.55 kW
Fuse rating ²⁾	24 / 12 A (T)	15 A (T)
Connection	4 - pole connector for power, 5 - pole connector for signals, 3 pole connector for RS 485 Modbus	
Ingress protection	IP 54 / Type 12	
Certification	CE, cURus, cULus	

¹⁾ Ambient / enclosure

²⁾ Values for 115 / 250 V

Filter options, cold air outlet ducts, anti vibration kits and other accessories on page 34

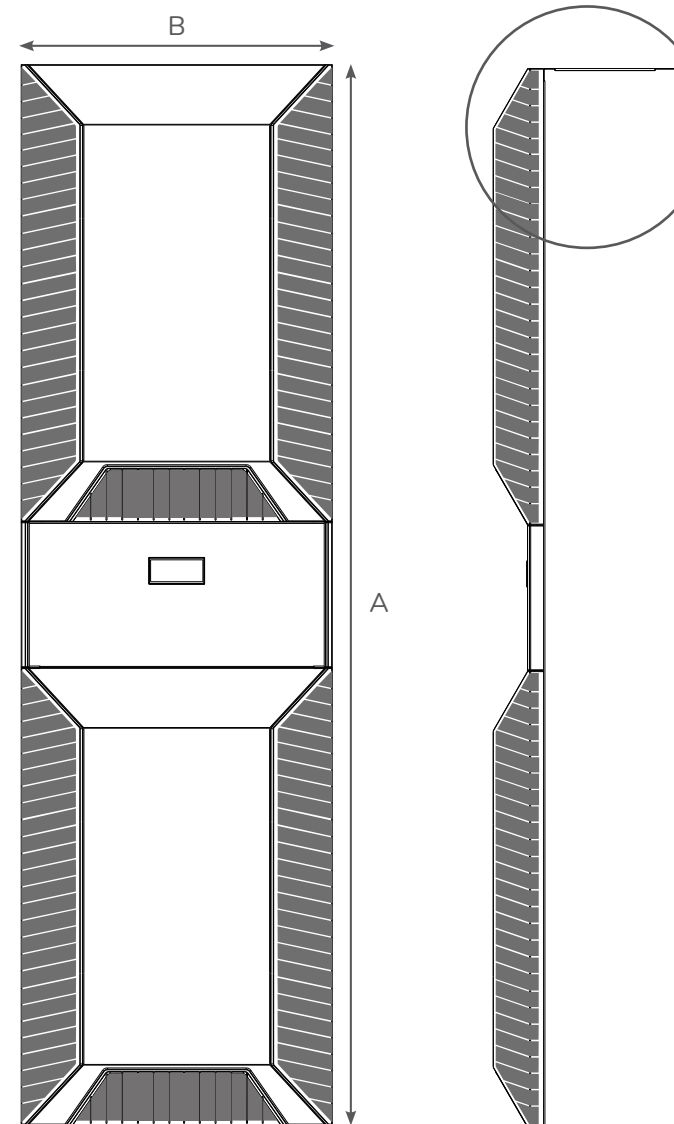
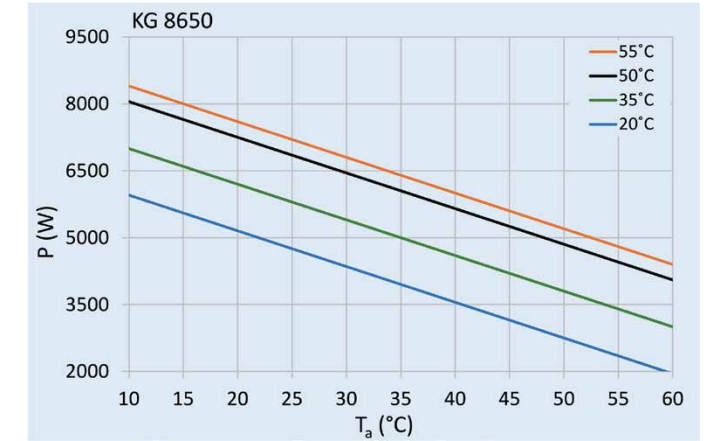
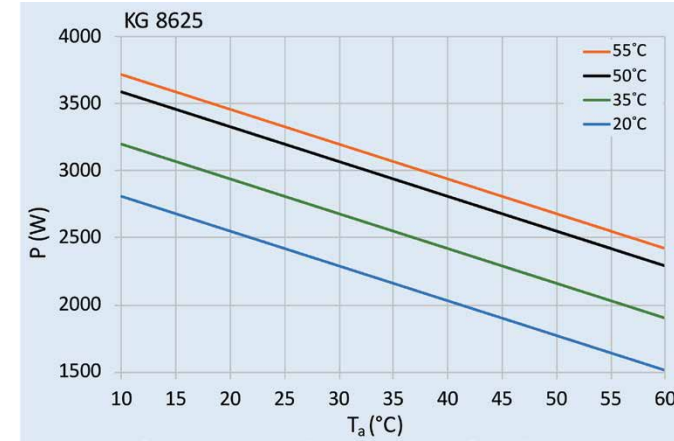

KG 8625 / 8650

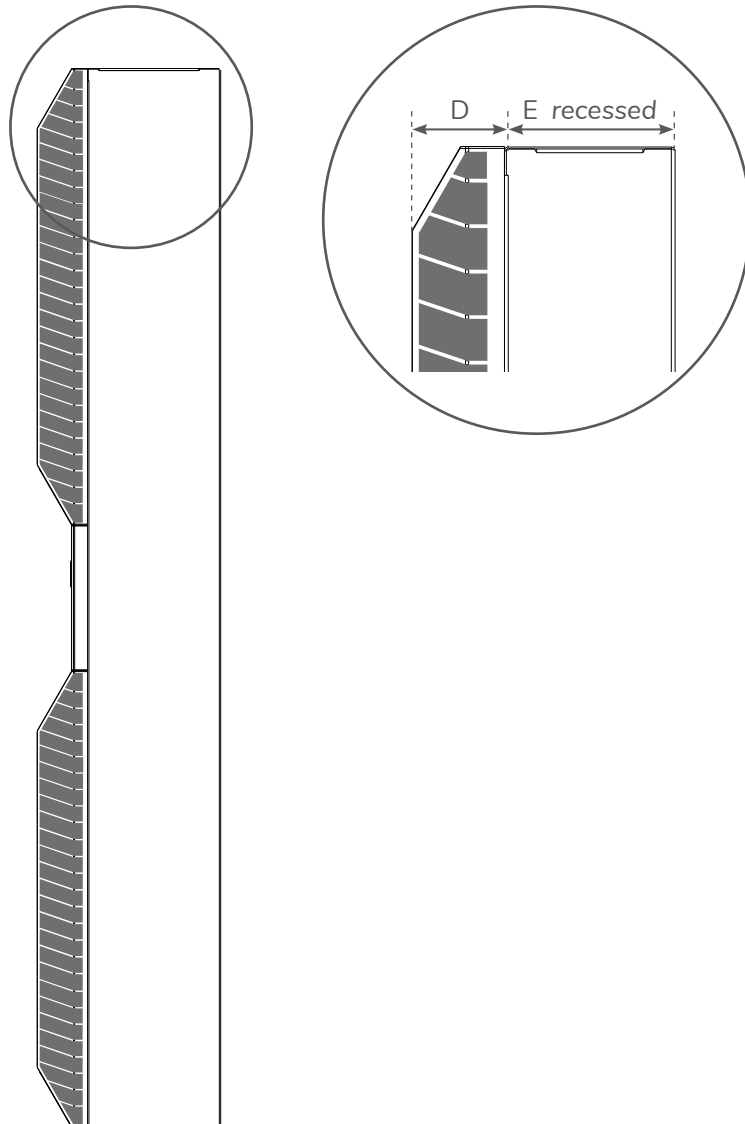

C wall mounted

SLIMLINE PRO / VARIO accesories

Order number	Description
AC-8503/06-BF-1	Washable aluminum filter for KG 8503 / 8506
AC-8508/12/8412-BF-1	Washable aluminum filter for KG 8508 / 8512 / 8412
AC-8515/20/25-BF-1	Washable aluminum filter for KG 8515 / 8520 / 8525
AC-8540/60-BF-1	Washable aluminum filter for KG 8540 / 8560
AC-8562-BF-1	Washable aluminum filter for KG 8562
AC-8625-BF-1	Washable aluminum filter for SLIMLINE VARIO KG 8625

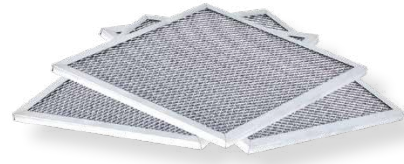

Order number	Description
AC-8503/06-BZ-1	Cold air outlet duct for KG 8503 / 8506
AC-8508/12/8412-BZ-1	Cold air outlet duct for KG 8508 / 8512 / 8412
AC-8515/20/25-BZ-1	Cold air outlet duct for KG 8515 / 8520 / 8525
AC-8540/62-BZ-1	Cold air outlet duct for KG 8540 / 8562

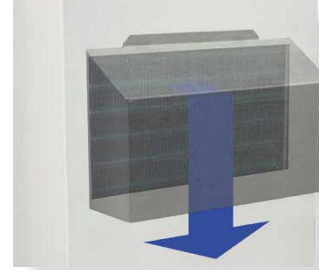

The cold air flow is directed downwards, resulting in a more evenly cooled enclosure. Reducing also the risk of condensation dropping on components and avoiding air short circuits.

Order number	Description
AC-8503/05/06-CS-1	Toroidal transformer for SLIMLINE PRO KG 8503 / 8505 / 8506 Primary: 115 / 400 / 460 V ± 10% 50/60 Hz ~N Secondary: 230 V ± 10% 50/60 Hz ~N 1,7 A



Order number	Description
AC-8508/12/8412-T-1	Anti vibration kit for KG 8508 / 8512 / 8412
AC-8515/20/25-T-1	Anti vibration kit for KG 8515 / 8520 / 8525
AC-8540/62-T-1	Anti vibration kit for KG 8540 / 8562

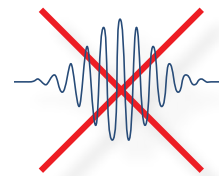

Reducing incoming / outgoing vibrations enables the cooling unit to be used on vibration sensitive machines.

Order number	Description
AC-8503/06-R-1	Gasket kit for KG 8503 / 8506
AC-8505-R-1	Gasket kit for KG 8505
AC-8508/12-R-1	Gasket kit for KG 8508 / 8512
AC-8412-R-1	Gasket kit for KG 8412
AC-8515/20/25-R-1	Gasket kit for KG 8515 / 8520 / 8525
AC-8540-R-1	Gasket kit for KG 8540
AC-8562-R-1	Gasket kit for KG 8562



By using the gasket kit (for wall mounting), the protection class for mild steel models will be increased to Type 3, 3R, 4.

Order number	Description
3100001	Door contact switch with mounting bracket, 2 x M4 screws

Compatible with the door contact interface of the cooling unit. Prevents the formation of condensation when the enclosure door is open.



MAXIMUM COOLING PERFORMANCE WITH MINIMUM INSTALLATION DEPTH

SLIMLINE ORIGINAL



FILTERLESS CONDENSER

FULL METAL HOUSING

PROTECTON CLASS
IP 54 / TYPE 12

HIGH QUALITY FANS

FILTERLESS ENCLOSURE COOLING FOR MORE RELIABILITY

SLIMLINE enclosure cooling units are characterised by maximum cooling capacity with minimum space requirements.

They operate completely without filters and have a condensate evaporation that does not consume any additional energy (from 820 W cooling capacity onwards).

SLIMLINE cooling units can be wall mounted or semi recessed. Thanks to the small cutouts, enclosure doors remain stable.

For challenging environments such as the food processing industry, SLIMLINE models can be fitted with NEMA 4X stainless steel covers.

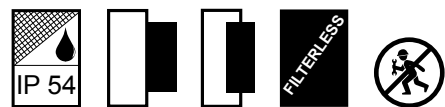



SLIMLINE

Filterless cooling for more reliability

KG 4266 - KG 4267

- ✓ Cooling capacities: 320 W and 400 W
- ✓ Completely filterless, thus maintenance free
- ✓ Only 110 mm deep, ideal for smaller enclosures
- ✓ Protection class IP 54 / Type 12
- ✓ Mounting template and condensation kit included
- ✓ NEMA 4X covers for stainless steel models available

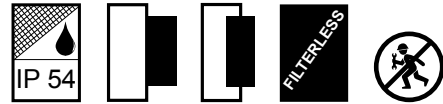

Model	KG 4266		KG 4267	
Order number	42660001	42661001	42670001	42671001
Order no. in stainless steel 304 (V2A)	42XXX02			
Cooling capacity L35L35 ¹⁾	320 / 330 W	330 / 330 W	400 / 425 W	425 / 425 W
Cooling capacity L35L50 ¹⁾	140 / 150 W	150 / 150 W	195 / 220 W	195 / 195 W
Compressor type	Rotary piston			
Operating temperature range	10°C - 50°C			
Setting range	20°C - 50°C			
System air flow ²⁾	170 / 125 m ³ /h		215 / 115 m ³ /h	
Unimpeded air flow ²⁾	250 / 250 m ³ /h		450 / 250 m ³ /h	
Mounting	Wall mounted / recessed			
Dimensions A x B x C (D+E)	520 x 270 x 110 (25+85) mm		340 x 520 x 110 (25+85) mm	
Housing material / colour	Mild steel powder coated / RAL 7035			
Weight	13 kg		14.8 kg	
ELECTRICAL DATA				
Voltage / Frequency	230 V ~ 50/60 Hz	120 V ~ 60 Hz	230 V ~ 50/60 Hz	120 V ~ 60 Hz
Current L35L35 ¹⁾	1.5 / 1.6 A	3.5 A	1.6 / 1.5 A	3.2 A
Starting current	3.2 A	7.1 A	3.2 A	7.4 A
Max. current	2.3 A	3.6 A	2.3 A	3.6 A
Nominal power L35L35 ¹⁾	315 / 335 W	315 W	350 / 346 W	350 W
Max. power	375 W		410 W	
Fuse rating	6 A (T)			
Connection	Terminal block			
IP Ingress protection	IP 54			
Certification	CE, cURus, cULus			

¹⁾ Values for 50/60 Hz

²⁾ Ambient / enclosure

NEMA 4X hoods and other accessories on page 44

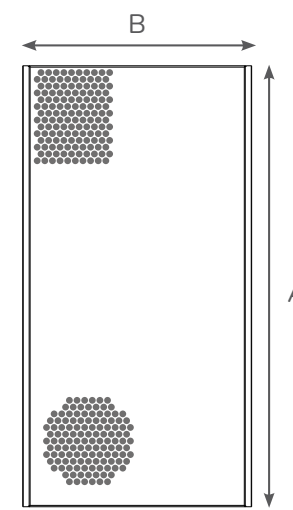
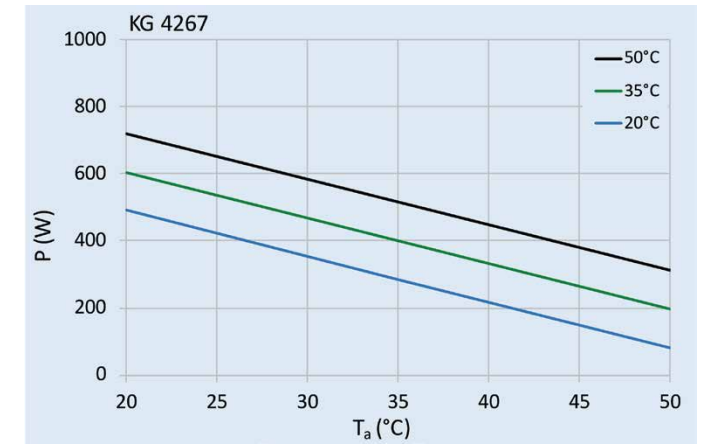
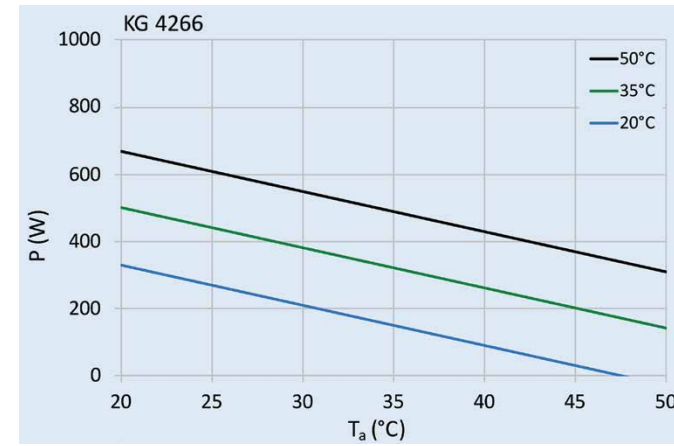

KG 4266

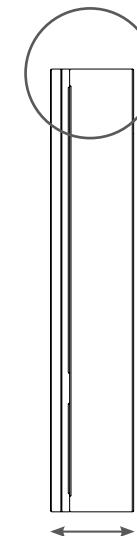

C wall mounted

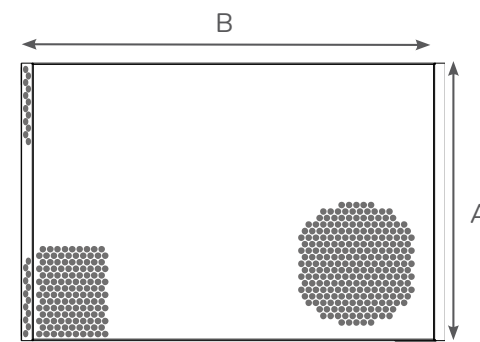
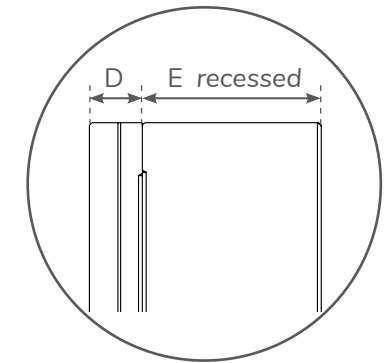

KG 4267

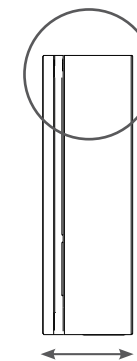

C wall mounted

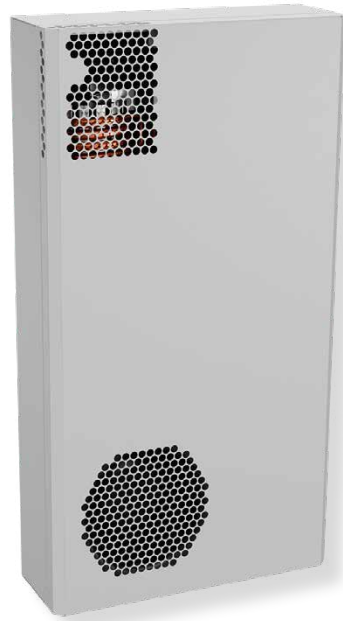

SLIMLINE

Filterless cooling for more reliability

KG 4269 - KG 4271

- ✓ Cooling capacities: 500 W and 820 W
- ✓ Completely filterless, thus maintenance free
- ✓ Only 110 mm deep, ideal for smaller enclosures (KG 4269)
- ✓ Protection class IP 54 / Type 12
- ✓ Mounting template and condensation kit included
- ✓ NEMA 4X covers for stainless steel models available

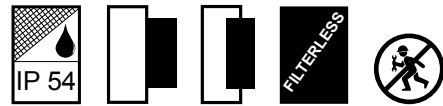

Model	KG 4269		KG 4271		
Order number	42690001	42691001	42710001	42711001	42712001
Order no. in stainless steel 304 (V2A)	42XXX02				
Cooling capacity L35L35 ¹⁾	500 / 520 W	520 / 520 W	820 / 885 W		
Cooling capacity L35L50 ¹⁾	160 / 180 W	180 / 180 W	480 / 530 W		
Compressor type	Rotary piston				
Operating temperature range	10°C - 50°C		10°C - 55°C		
Setting range	20°C - 50°C				
System air flow ²⁾	250 / 125 m ³ /h		320 / 290 m ³ /h		
Unimpeded air flow ²⁾	650 / 250 m ³ /h		650 / 550 m ³ /h		
Mounting	Wall mounted / recessed				
Dimensions A x B x C (D+E)	600 x 320 x 110 (25+85) mm		980 x 395 x 145 (25+120) mm		
Housing material / colour	Mild steel powder coated, RAL 7035				
Weight	15.8 kg	33 kg	34 kg	38 kg	
ELECTRICAL DATA					
Voltage / Frequency	230 V ~ 50/60 Hz	120 V ~ 60 Hz	230 V ~ 50/60 Hz	120 V ~ 50/60 Hz	380-415 V 50 Hz 3~ 400-460 V 60 Hz 3~
Current L35L35 ¹⁾	2.4 / 2.6 A	4.5 A	3.3 / 3.7 A	6.6 / 7.0 A	1.8 / 2.1 A
Starting current	5.8 A	14.6 A	15.5 A	37 A	8.2 A
Max. current	2.8 A	5.3 A	4.3 A	8.7 A	2.9 A
Nominal power L35L35 ¹⁾	480 / 490 W	475 W	660 / 760 W		
Max. power	560 W	550 W	850 W	905 W	840 W
Fuse rating	6 A (T)		10 A (T)	16 A (T)	3 x 6 A (T)
Connection	Terminal block				
IP Ingress protection	IP 54				
Certification	CE, cURus, cULus				

¹⁾ Values for 50/60 Hz

²⁾ Ambient / enclosure

NEMA 4X hoods and other accessories on page 44

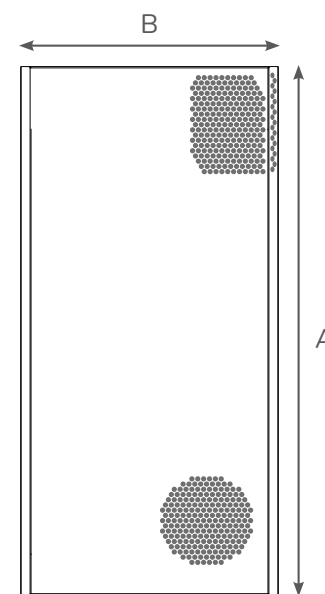
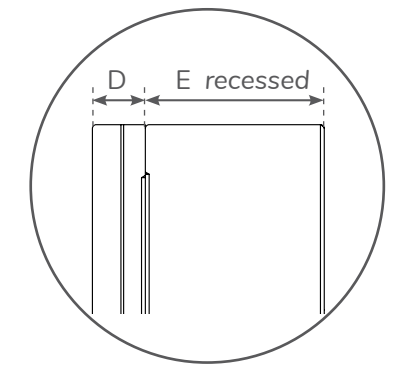
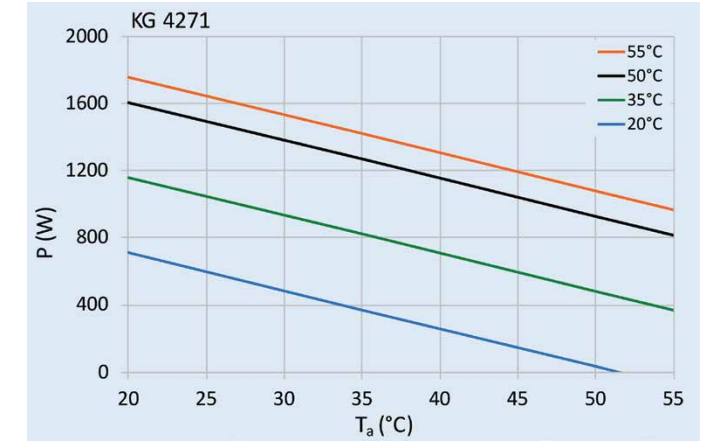
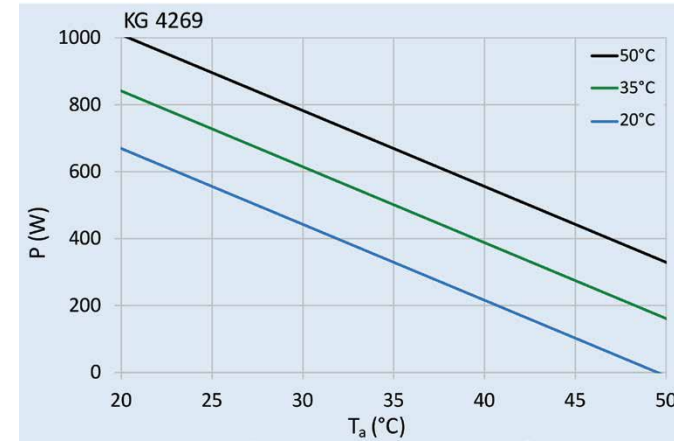

KG 4269 / 71

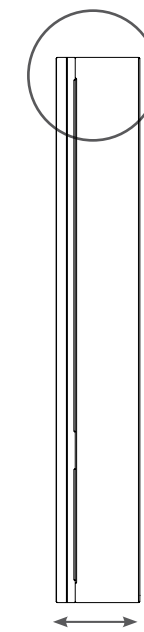

C wall mounted



SLIMLINE

Filterless cooling for more reliability

KG 4272 - KG 4274

- ✓ Cooling capacities: 1.1 kW and 1.5 kW
- ✓ Completely filterless, thus maintenance free
- ✓ Protection class IP 54 / Type 12
- ✓ Mounting template and condensation kit included
- ✓ NEMA 4X covers for stainless steel models available

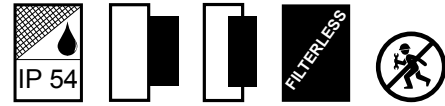

Model	KG 4272			KG 4274		
Order number	42720001	42721001	42722001	42740001	42741001	42742001
Order no. in stainless steel 304 (V2A)	42XXX02					
Cooling capacity L35L35 ¹⁾	1.1 / 1.2 kW	1.2 kW	1.1 / 1.2 kW	1.5 / 1.5 kW	1.4 / 1.4 kW	1.5 / 1.5 kW
Cooling capacity L35L50 ¹⁾	850 / 870 W	870 W	850 / 870 W	1.2 / 1.2 kW	950 / 950 W	1.2 / 1.2 kW
Compressor type	Rotary piston					
Operating temperature range	10°C - 55°C					
Setting range	20°C - 50°C					
System air flow ²⁾	430 / 200 m ³ /h			430 / 200 m ³ /h		
Unimpeded air flow ²⁾	1,200 / 550 m ³ /h			1,200 / 850 m ³ /h		
Mounting	Wall mounted / recessed					
Dimensions A x B x C (D+E)	1,250 x 395 x 145 (25+120) mm			1,550 x 395 x 145 (25+120) mm		
Housing material / colour	Mild steel powder coated, RAL 7035					
Weight	40 kg		41 kg			50 kg
ELECTRICAL DATA						
Voltage / Frequency	230 V ~ 50/60 Hz	120 V ~ 60 Hz	380-415 V 50 Hz 3~ 400-460 V 60 Hz 3~	230 V ~ 50/60 Hz	120 V ~ 60 Hz	380-415 V 50 Hz 3~ 400-460 V 60 Hz 3~
Current L35L35 ¹⁾	3.4 / 4.1 A	8 A	1.6 / 1.5 A	4.3 / 5.5 A	8.8 A	1.8 / 2.0 A
Starting current	15.5 A	37 A	8.2 A	22 A	37 A	13 A
Max. current	4.5 A	10 A	1.8 A	7 A	12.1 A	3.2 A
Nominal power L35L35 ¹⁾	740 / 865 W	900 W	830 / 850 W	1 / 1.23 kW	1 kW	1 / 1.2 kW
Max. power	1.04 kW	1.1 kW	1.04 kW	1.58 kW	1.34 kW	1.53 kW
Fuse rating	10 A (T)	16 A (T)	3 x 6 A (T)	10 A (T)	16 A (T)	3 x 6 A (T)
Connection	Terminal block					
IP Ingress protection	IP 54					
Certification	CE, cURus, cULus					

¹⁾ Values for 50/60 Hz

²⁾ Ambient / enclosure

NEMA 4X hoods and other accessories on page 44

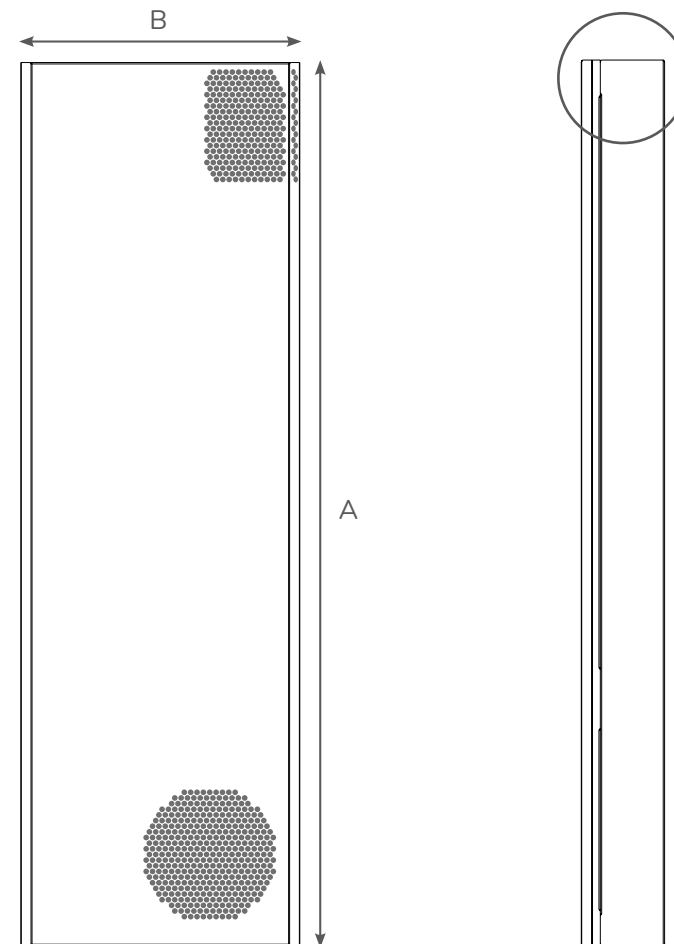
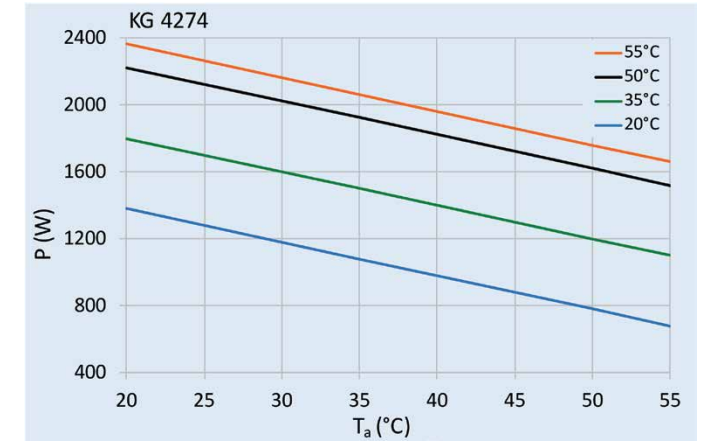
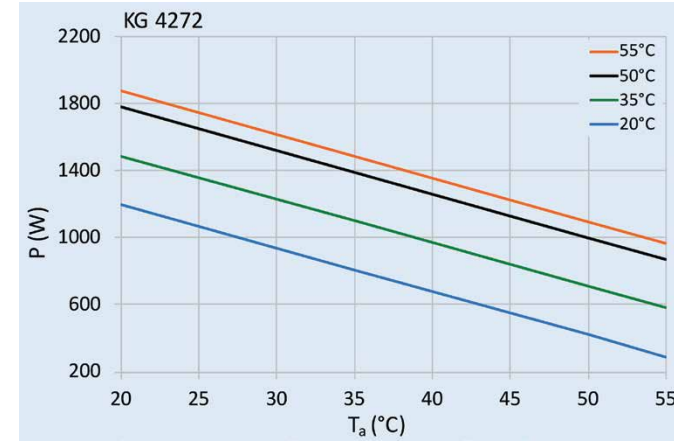

KG 4272 / 74

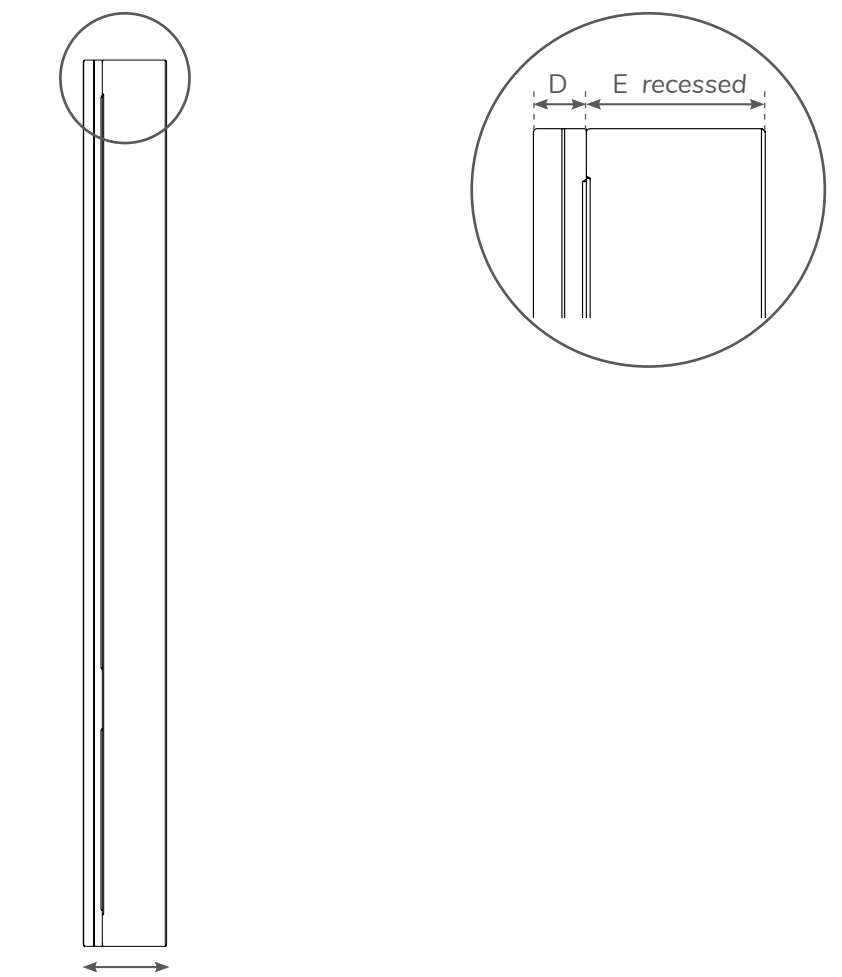

C wall mounted

SLIMLINE accessories

Order number	Description
S/M 5930046698	NEMA 4X stainless steel hood for SLIMLINE KG 4266X02
S/M 5930048052	NEMA 4X stainless steel hood for SLIMLINE KG 4269X02
S/M 5930018030	NEMA 4X stainless steel hood for SLIMLINE KG 4271X02
S/M 5930019200	NEMA 4X stainless steel hood for SLIMLINE KG 4272X02
S/M 5930016726	NEMA 4X stainless steel hood for SLIMLINE KG 4274X02

Increases the protection class of the cooling unit to NEMA 4X (only for units with a stainless steel housing). Ideally suited for use in food processing.



Order number	Description
AC-8503/05/06-CS-1	Toroidal transformer for SLIMLINE KG 4266 / 4267 / 4269 Primary: 115 / 400 / 460 V ± 10% 50/60 Hz ~N Secondary: 230 V ± 10% 50/60 Hz ~N 1,7 A



Order number	Description
3100001	Door contact switch with mounting bracket, 2 x M4 screws

Compatible with the door contact interface of the cooling unit. Prevents the formation of condensation when the enclosure door is open.



WHEN THERE IS NO SPACE ON ENCLOSURE DOORS OR WALLS

SLIMLINE TOP

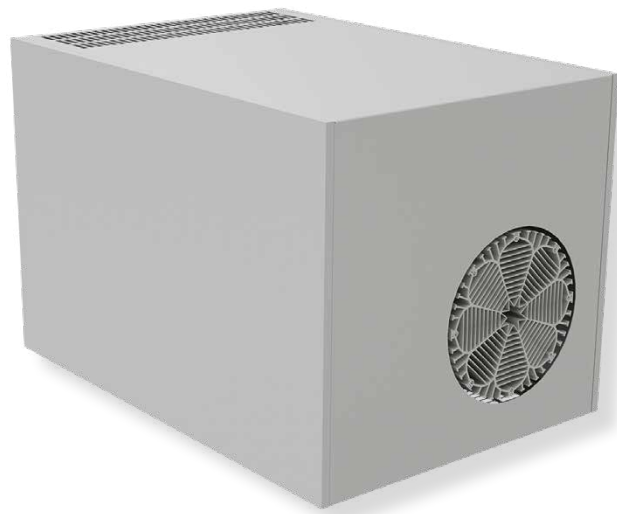

FILTERLESS CONDENSER



PROTECTON CLASS IP 54 / TYPE 12

SPACE SAVING ROOF MOUNTED ENCLOSURE COOLING

SOLITHERM TOP roof mounted enclosure cooling units work completely without filters and are therefore maintenance free and guarantee a high level of safety for electronic equipment.

They are characterised by maximum cooling performance with minimal space requirements.

SOLITHERM TOP are energy efficient and environmentally friendly and are the suitable alternative for enclosure cooling when there is no space on the enclosure walls or on the door.

This creates additional space in narrow aisles or for escape routes between rows of control cabinets.

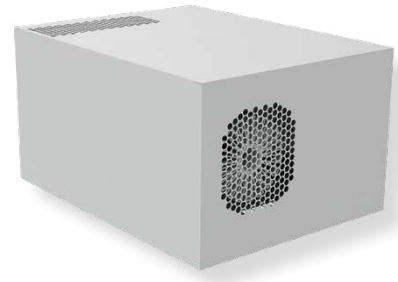

SLIMLINE TOP

For when no other space is available

KG 4482 - KG 4555

- ✓ Cooling capacities: 450 W and 1.1 kW
- ✓ Maximum cooling power with minimum space
- ✓ Completely filterless, thus virtually maintenance free
- ✓ Mounting template and condensation kit included



Model	KG 4482		KG 4555		
Order number	44820001	44821001	45550001	45551001	45552001
Order no. in stainless steel 304 (V2A)	4482X02		4555X02		
Cooling capacity L35L35 ¹⁾	450 / 460 W	460 W	1,10 / 1,15 kW	1,1 kW	1,10 / 1,15 kW
Cooling capacity L35L50 ¹⁾	280 W		700 / 750 W	700 W	700 / 750 W
Compressor type	Rotary piston				
Operating temperature range	10°C - 50°C		10°C - 55°C		
Setting range	20°C - 50°C				
System air flow ²⁾	250 / 140 m ³ /h		360 / 500 m ³ /h		
Unimpeded air flow ²⁾	650 / 250 m ³ /h		1,200 / 650 m ³ /h		
Mounting	Roof mounted				
Dimensions A x B x C	230 x 330 x 430 mm		400 x 400 x 600 mm		
Housing material / colour	Mild steel powder coated, RAL 7035				
Weight	23 kg		55 kg		
ELECTRICAL DATA					
Voltage / Frequency	230 V ~ 50/60 Hz	120 V ~ 60 Hz	230 V ~ 50/60 Hz	120 V ~ 60 Hz	380-415 V 50 Hz 3~ 400-460 V 60 Hz 3~
Current L35L35 ¹⁾	2.3 A	4.2 A	4 / 4.4 A	8 A	2.3 / 2.5 A
Starting current	6.8 A	17 A	15 A	37 A	8.2 A
Max. current	2.8 A	5.2 A	4.8 A	9.6 A	2.8 A
Nominal power L35L35 ¹⁾	475 / 530 W	480 W	800 / 900 W	800 W	800 / 900 W
Max. power	630 W	590 W	1.09 kW		
Fuse rating	6 A (T)		10 A (T)	16 A (T)	3 x 6 A (T)
Connection	Terminal block				
Ingress protection	IP 54				
Certification	CE, cURus				

¹⁾ Values for 50/60 Hz

²⁾ Ambient / enclosure

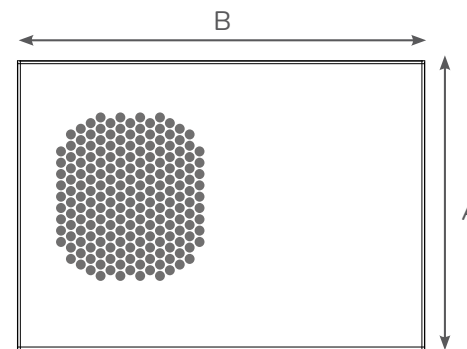
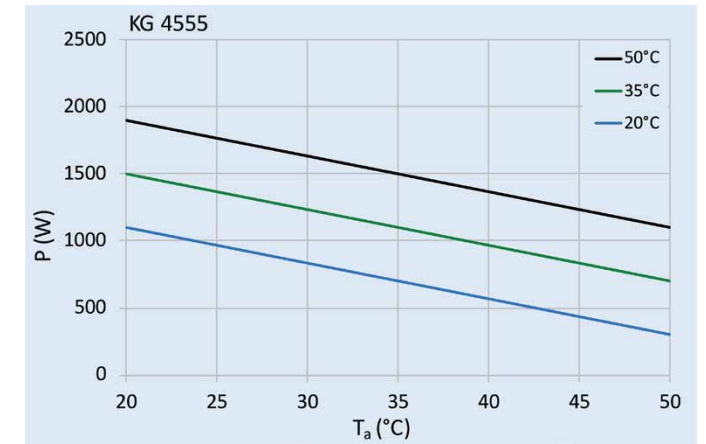
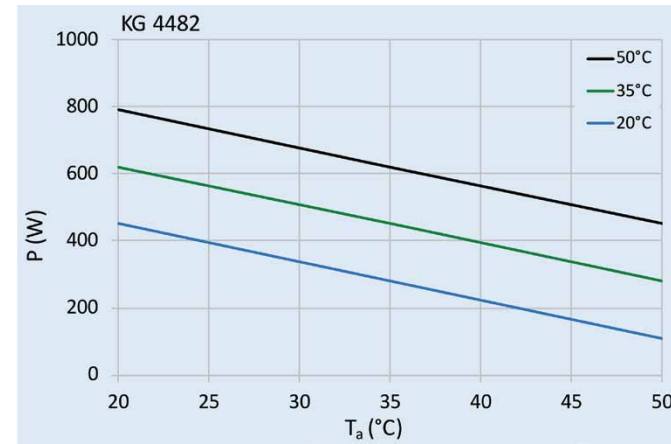

KG 4482

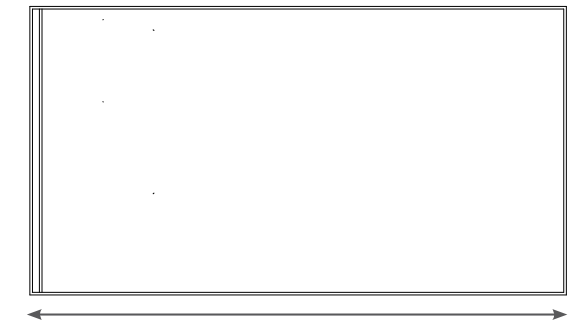

C

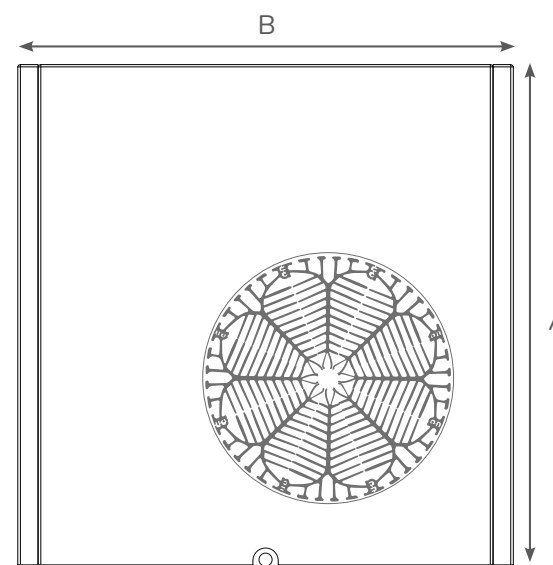

KG 4555



C

LOW MAINTENANCE ENCLOSURE COOLING FOR INDUSTRIAL USE

COMPACT INDOOR

NANO COATED CONDENSER



COMPACT DESIGN

VARIOUS FILTER OPTIONS

CONTROLLER WITH DISPLAY

PROTECTION CLASS IP 54 / TYPE 12

ECONOMICAL ENCLOSURE COOLING

Thanks to the nano coated condenser, COMPACT INDOOR enclosure cooling units can be used for most industrial applications without a filter.

The large fins of the condenser (> 4 mm) allow dust and smaller particles to flow through. This reduces the risk of the condenser becoming clogged and extends the cleaning and maintenance intervals.

Various filter media can be retrofitted for particularly heavily contaminated environments.

COMPACT INDOOR cooling units have a powder coated sheet metal housing as standard and can be supplied for wall or recessed mounting.

For applications where hygiene or high corrosion protection is important, they can be ordered with a stainless steel hood.

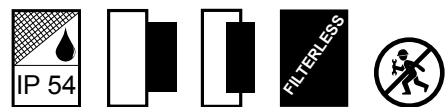



COMPACT INDOOR

The economical all-round solution

KG 4304 - KG 4305

- ✓ Cooling capacities: 320 W and 550 W
- ✓ Nano coated hydrophobic condenser
- ✓ Various filter options for polluted environments
- ✓ Adjustable electronic controller with display
- ✓ Condensate evaporator optional from 500 W units onwards
- ✓ Mounting template and condensation kit included

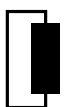

Model	KG 4304			KG 4305		
Order no. wall mounting	43040001	43041001	43042001	43050001	43051001	43052001
Order no. recess mounting	On request			43050081	43051081	43052081
Order no. in stainless steel 304 (V2A)	43XXXX2					
Cooling capacity L35L35 ¹⁾	320 / 360 W	360 W	320 / 360 W	550 / 620 W	620 W	550 / 620 W
Cooling capacity L35L50 ¹⁾	200 / 220 W	220 W	200 / 220 W	410 / 440 W	440 W	410 / 440 W
Compressor type	Reciprocating					
Operating temperature range	10°C - 55°C					
Setting range	20°C - 50°C					
System air flow ²⁾	90 / 115 m³/h			435 / 200 m³/h		
Unimpeded air flow ²⁾	250 / 136 m³/h			550 / 250 m³/h		
Mounting	Wall mounted / recessed					
Dimensions A x B x C wall mounted	501.6 x 280 x 200 mm			650 x 315 x 260 mm	651.4 x 315 x 260 mm	
Dimensions A x B x C (D+E) recessed	On request			715 x 372 x 260 (170+90) mm		
Housing material / colour	Mild steel powder coated / RAL 7035					
Weight	19.5 kg	26 kg	27.7 kg	33.7 kg		
ELECTRICAL DATA						
Voltage / Frequency	230 V ~ 50/60 Hz	120 V ~ 60 Hz	400 / 460 V ~ 50/60 Hz 2~	230 V ~ 50/60 Hz	120 V ~ 60 Hz	400 / 460 V ~ 50/60 Hz 2~
Current L35L35 ¹⁾	1.9 / 2 A	4.4 A	1.1 / 1 A	2.1 A	4.4 A	1.4 / 1.2 A
Starting current	6.1 A	12.5 A	3.8 A	9.8 A	19.1 A	4.3 A
Max. current	2.8 A	5.4 A	1.4 A	2.5 A	5.3 A	1.6 A
Nominal power L35L35 ¹⁾	335 / 380 W	440 W		370 / 400 W	440 W	
Max. power	550 W			510 W	560 W	
Fuse rating	6 A (T)	10 A (T)	2 x 3.6 A (T)	6 A (T)	10 A (T)	2 x 3.6 A (T)
Connection	Terminal block					
Ingress Protection	IP 54					
Certification	CE, cURus, cULus					

¹⁾ Values for 50/60 Hz

²⁾ Ambient / enclosure

Various filter options and other accessories on page 62

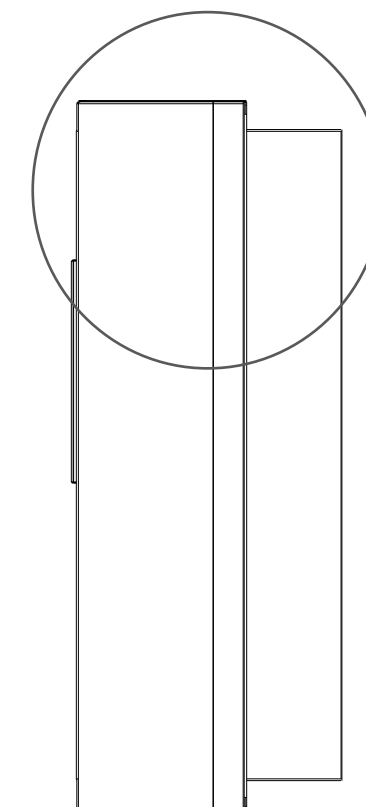
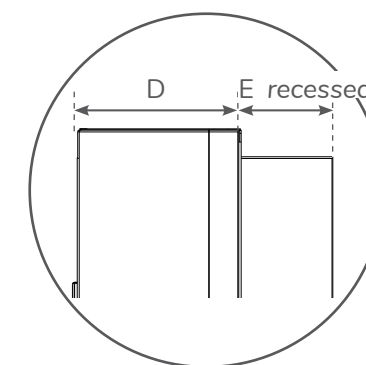
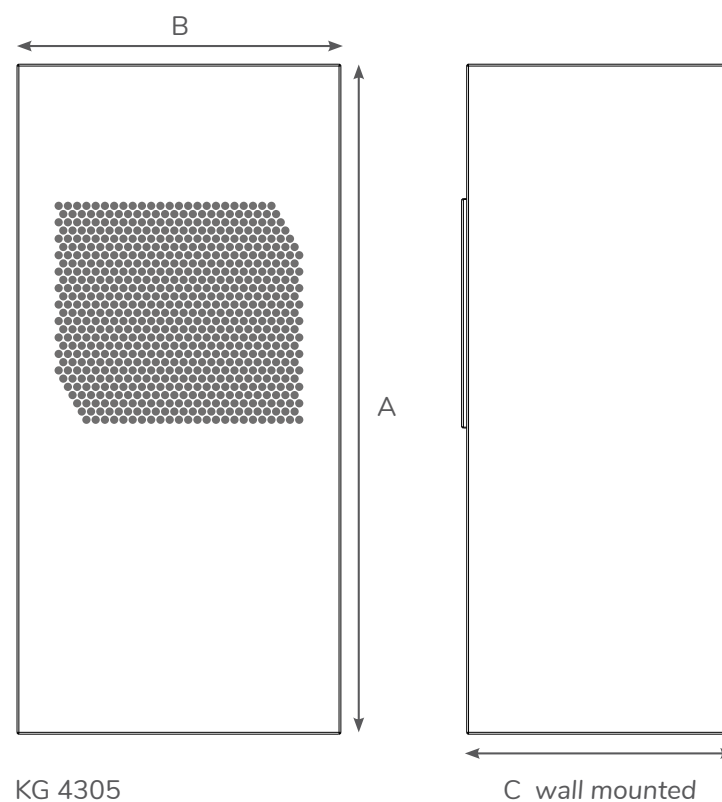
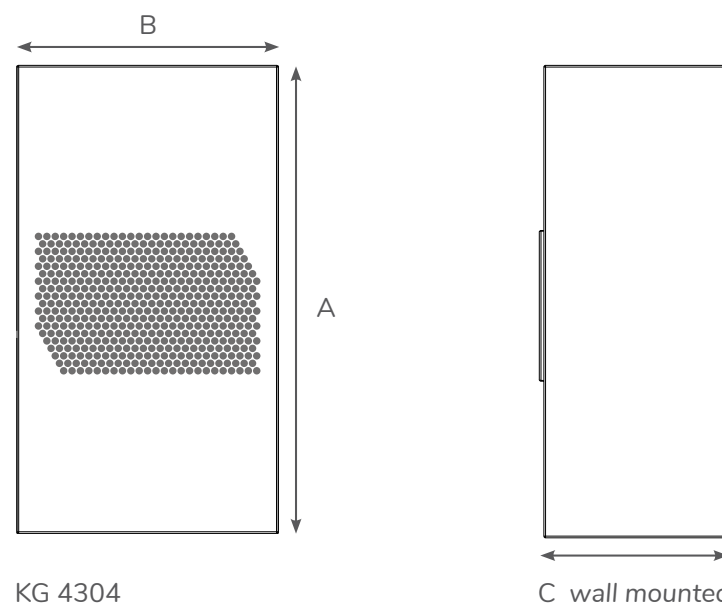
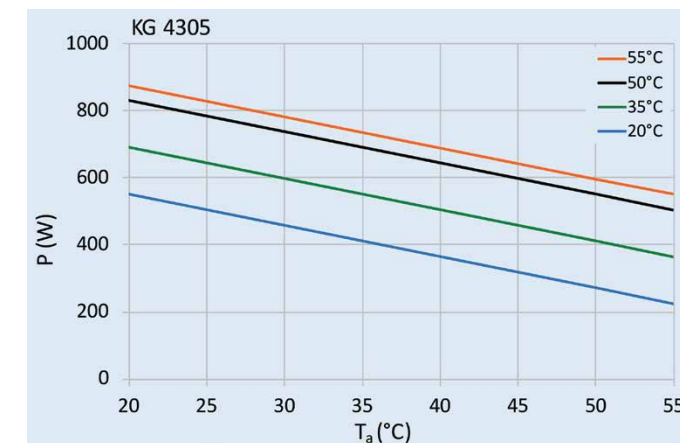
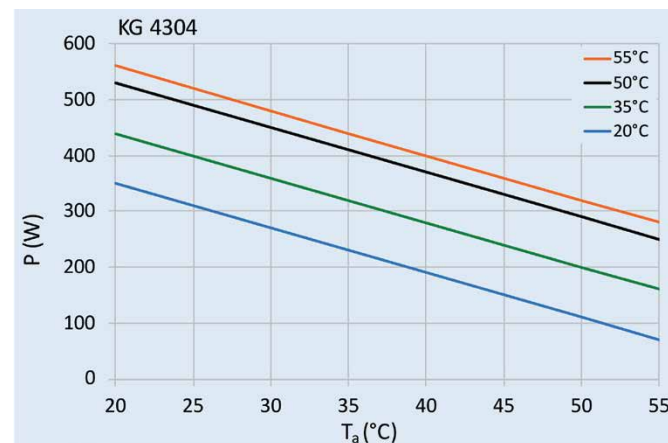



COMPACT INDOOR

The economical all-round solution

KG 4309 - KG 4310

- ✓ Cooling capacities: 850 W and 1 kW
- ✓ Nano coated hydrophobic condenser
- ✓ Various filter options for polluted environments
- ✓ Adjustable electronic controller with display
- ✓ Condensate evaporator optional
- ✓ Mounting template and condensation kit included

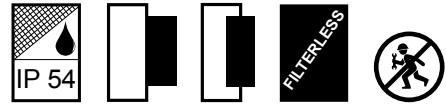

Model	KG 4309			KG 4310		
Order no. wall mounting	43090001	43091001	43092001	43100001	43101001	43102001
Order no. recess mounting	43090081	43091081	43092081	43100081	43101081	43102081
Order no. in stainless steel 304 (V2A)	43XXXX2					
Cooling capacity L35L35 ¹⁾	850 / 880 W	880 W	850 / 880 W	1.00 / 1.08 kW	1.08 kW	1.00 / 1.08 kW
Cooling capacity L35L50 ¹⁾	640 / 665 W	660 W	640 / 665 W	730 / 745 W	745 W	730 / 745 W
Compressor type	Reciprocating					
Operating temperature range	10°C - 55°C					
Setting range	20°C - 55°C					
System air flow ²⁾	435 / 200 m ³ /h			410 / 300 m ³ /h		
Unimpeded air flow ²⁾	550 / 250 m ³ /h			850 / 550 m ³ /h		
Mounting	Wall mounted / recessed					
Dimensions A x B x C wall mounted	651.4 x 315 x 260 mm					
Dimensions A x B x C (D+E) recessed	715 x 372 x 260 (170+90) mm					
Housing material / colour	Mild steel powder coated / RAL 7035					
Weight	30 kg	36 kg		30 kg	36 kg	
ELECTRICAL DATA						
Voltage / Frequency	230 V ~ 50/60 Hz	120 V ~ 60 Hz	400 / 460 V ~ 50/60 Hz 2~	230 V ~ 50/60 Hz	120 V ~ 60 Hz	400 / 460 V ~ 50/60 Hz 2~
Current L35L35 ¹⁾	3 / 3.2 A	6.4 A	2 / 1.8 A	3.2 A	6.7 A	1.8 / 2 A
Starting current	15.9 A	30 A	5.1 A	15.9 A	30.2 A	5.1 A
Max. current	4.1 A	8.2 A	2.6 A	4.1 A	8.6 A	2.6 A
Nominal power L35L35 ¹⁾	530 / 610 W	640 W		550 / 640 W	700 W	
Max. power	810 W	870 W		820 W	900 W	
Fuse rating	10 A (T)	16 A (T)	2 x 3.6 A (T)	10 A (T)	16 A (T)	2 x 3.6 A (T)
Connection	Terminal block					
Ingress Protection	IP 54					
Certification	CE, cURus, cULus					

¹⁾ Values for 50/60 Hz

²⁾ Ambient / enclosure

Various filter options and other accessories on page 62

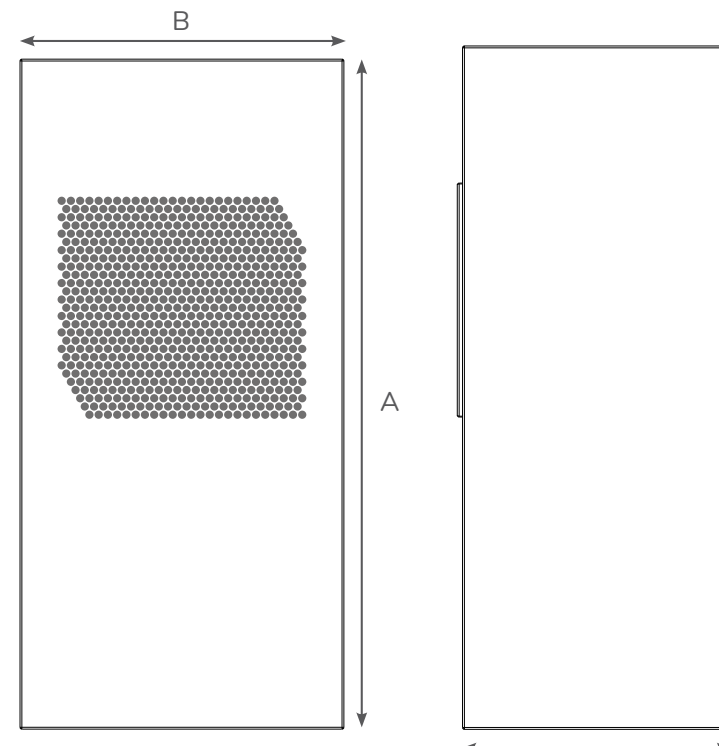
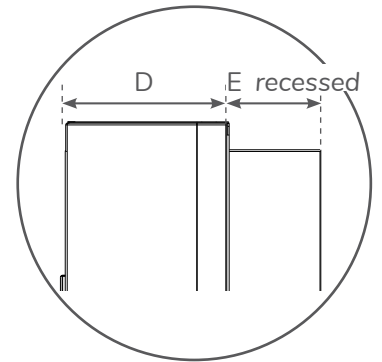
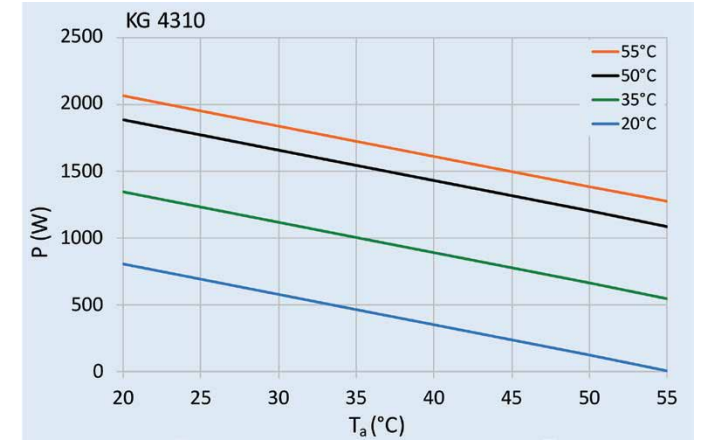
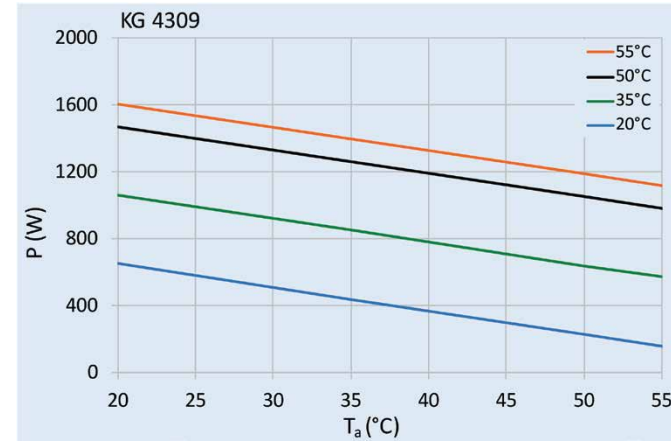

KG 4309 / 10

C wall mounted

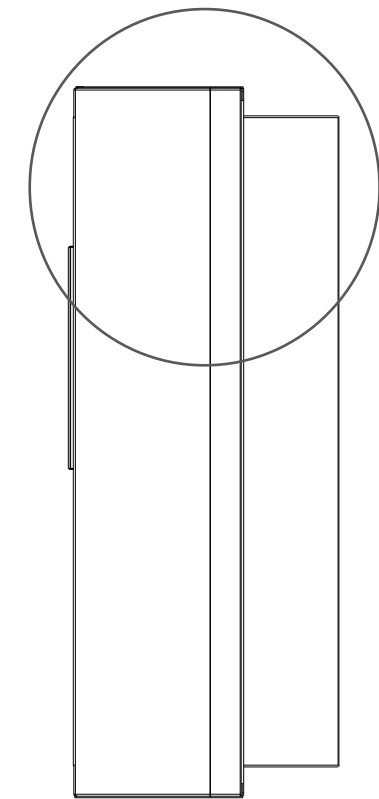



COMPACT INDOOR

The economical all-round solution

KG 4315 - KG 4320

- ✓ Cooling capacities: 1.5 kW and 2 kW
- ✓ Nano coated hydrophobic condenser
- ✓ Various filter options for polluted environments
- ✓ Adjustable electronic controller with display
- ✓ Condensate evaporator optional
- ✓ Mounting template and condensation kit included

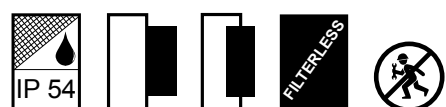

Model	KG 4315			KG 4320		
Order no. wall mounting	43150001	43151001	43152001	43200001	43201001	43202001
Order no. recess mounting	43150081	43151081	43152081	43200081	43201081	43202081
Order no. in stainless steel 304 (V2A)	43XXXX2					
Cooling capacity L35L35 ¹⁾	1.50 / 1.63 kW	1.63 kW	1.50 / 1.63 kW	2.0 / 2.0 kW		
Cooling capacity L35L50 ¹⁾	1.22 / 1.32 kW	1.32 kW	1.22 / 1.32 kW	1.60 / 1.65 kW	1.65 kW	1.60 / 1.65 kW
Compressor type	Reciprocating					
Operating temperature range	10°C - 55°C					
Setting range	20°C - 55°C					
System air flow ²⁾	480 / 385 m ³ /h			650 / 470 m ³ /h		
Unimpeded air flow ²⁾	850 / 550 m ³ /h			1,200 / 850 m ³ /h		
Mounting	Wall mounted / recessed					
Dimensions A x B x C wall mounted	980 x 395 x 260 mm					
Dimensions A x B x C (D+E) recessed	1,045 x 452 x 270 (180+90) mm					
Housing material / colour	Mild steel powder coated / RAL 7035					
Weight	39.7 kg	47.7 kg	44.2 kg	50 kg	44.2 kg	
ELECTRICAL DATA						
Voltage / Frequency	230 V ~ 50/60 Hz	120 V ~ 60 Hz	400 / 460 V ~ 50/60 Hz 2~	230 V ~ 50/60 Hz	120 V ~ 60 Hz	380-415 V 50 Hz 3~ 400-460 V 60 Hz 3~
Current L35L35 ¹⁾	4.6 / 5.1 A	9.6 A	2.9 / 2.5 A	5.5 / 6.5 A	11.2 A	3.1 / 2.7 A
Starting current ¹⁾	21.2 A	39.4 A	5.3 A	22.3 A	40.1 A	5.7 / 6.1 A
Max. current ¹⁾	5.6 A	11.8 A	3.5 A	9.4 A	18.8 A	3.6 / 3.2 A
Nominal power L35L35 ¹⁾	800 / 920 W	880 W		1.17 / 1.41 kW	1.28 kW	1.26 / 1.35 kW
Max. power	1.17 kW	1.29 kW		1.65 / 2.1 kW	1.42 kW	
Fuse rating	10 A (T)	16 A (T)	2 x 6 A (T)	10 A (T)	20 A (T)	3 x 6 A (T)
Connection	Terminal block					
Ingress Protection	IP 54					
Certification	CE, cURus, cULus					

¹⁾ Values for 50/60 Hz

²⁾ Ambient / enclosure

Various filter options and other accessories on page 62

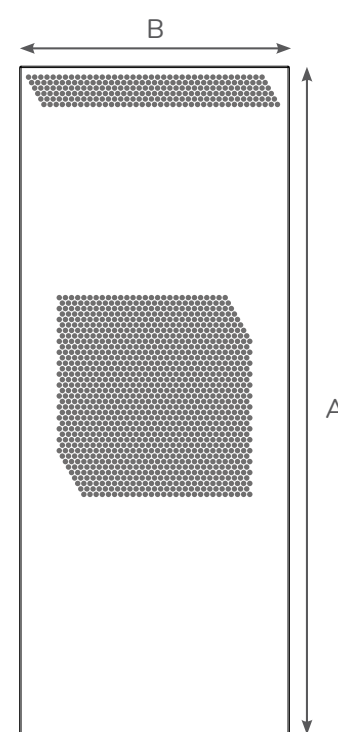
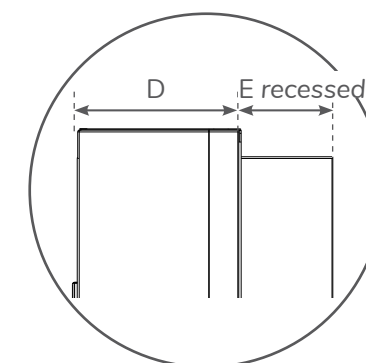
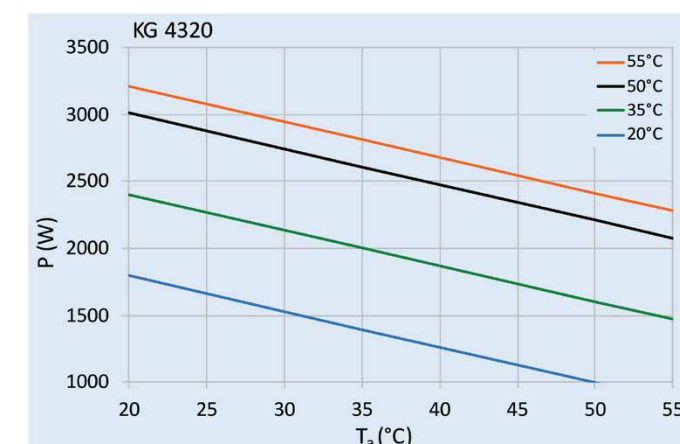
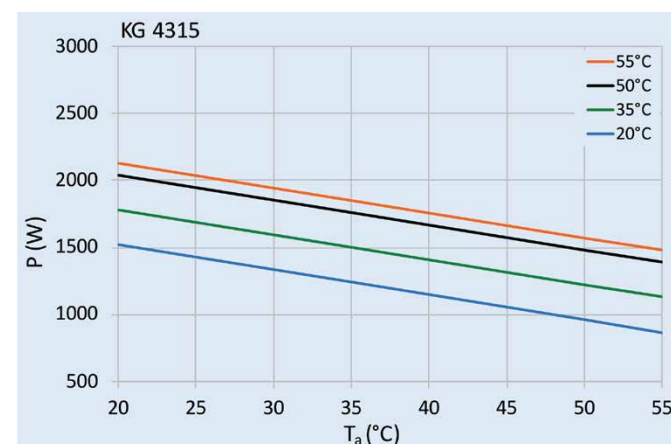

KG 4315 / 20

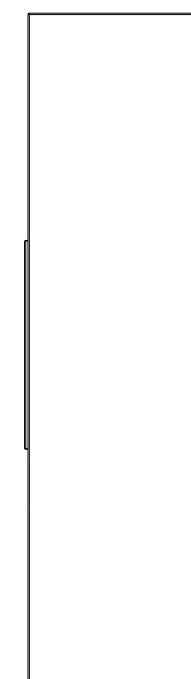

C wall mounted

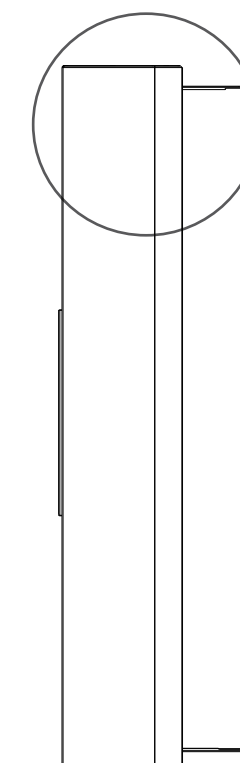



COMPACT INDOOR

The economical all-round solution

KG 4325 - KG 4330

- ✓ Cooling capacities: 2.5 kW and 3 kW
- ✓ Nano coated hydrophobic condenser
- ✓ Various filter options for polluted environments
- ✓ Adjustable electronic controller with display
- ✓ Condensate evaporator optional
- ✓ Mounting template and condensation kit included

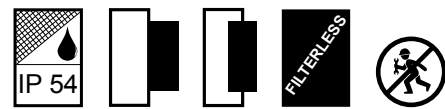

Model	KG 4325			KG 4330		
Order no. wall mounting	43250001	43251001	43252001	43300001	43301001	43302001
Order no. recess mounting	43250081	43251081	43252081	43300081	43301081	43302081
Order no. in stainless steel 304 (V2A)	43XXXX2					
Cooling capacity L35L35 ¹⁾	2.50 / 2.51 kW	2.50 kW	2.50 / 2.51 kW	3.0 / 3.0 kW		
Cooling capacity L35L50 ¹⁾	1.97 / 2.10 kW	2.04 kW	1.97 / 2.10 kW	2.38 / 2.51 kW	2.42 kW	2.38 / 2.51 kW
Compressor type	Rotary piston					
Operating temperature range	10°C - 55°C					
Setting range	20°C - 55°C					
System air flow ²⁾	750 / 550 m³/h			750 / 860 m³/h		
Unimpeded air flow ²⁾	1,200 / 1,200 m³/h			1,200 / 1,200 m³/h		
Mounting	Wall mounted / recessed					
Dimensions A x B x C wall mounted	1,230 x 500 x 340 mm					
Dimensions A x B x C (D+E) recessed	1,295 x 557 x 340 (250+90) mm					
Housing material / colour	Mild steel powder coated / RAL 7035					
Weight	65 kg	73 kg	67.5 kg	75 kg	72.5 kg	
ELECTRICAL DATA						
Voltage / Frequency	230 V ~ 50/60 Hz	120 V ~ 60 Hz	400 / 460 V ~ 50/60 Hz 2~	230 V ~ 50/60 Hz	120 V ~ 60 Hz	380-415 V 50 Hz 3~ 400-460 V 60 Hz 3~
Current L35L35 ¹⁾	3.9 / 5.3 A	8.7 A	2.9 / 2.6 A	5.6 / 7.6 A	15.3 A	2.1 / 2.3 A
Starting current	23 A	45.1 A	6.1 / 6.8 A	25.1 A	49 A	7.6 / 8.1 A
Max. current ¹⁾	6.6 A	13.5 A	3.8 / 3.2 A	9.2 A	18.4 A	3.3 / 3.5 A
Nominal power L35L35 ¹⁾	0.91 / 1.16 kW	970 W	0.94 / 1.18 kW	1.33 / 1.69 kW	1.37 kW	1.34 / 1.7 kW
Max. power	1.19 / 1.48 kW	1.27 kW	1.25 / 1.46 kW	2.06 kW	1.65 kW	1.66 / 2.10 kW
Fuse rating	10 A (T)	16 A (T)	2 x 6 A (T)	16 A (T)	20 A (T)	3 x 6 A (T)
Connection	Terminal block					
Ingress Protection	IP 54					
Certification	CE, cURus, cULus					

¹⁾ Values for 50/60 Hz

²⁾ Ambient / enclosure

Various filter options and other accessories on page 62

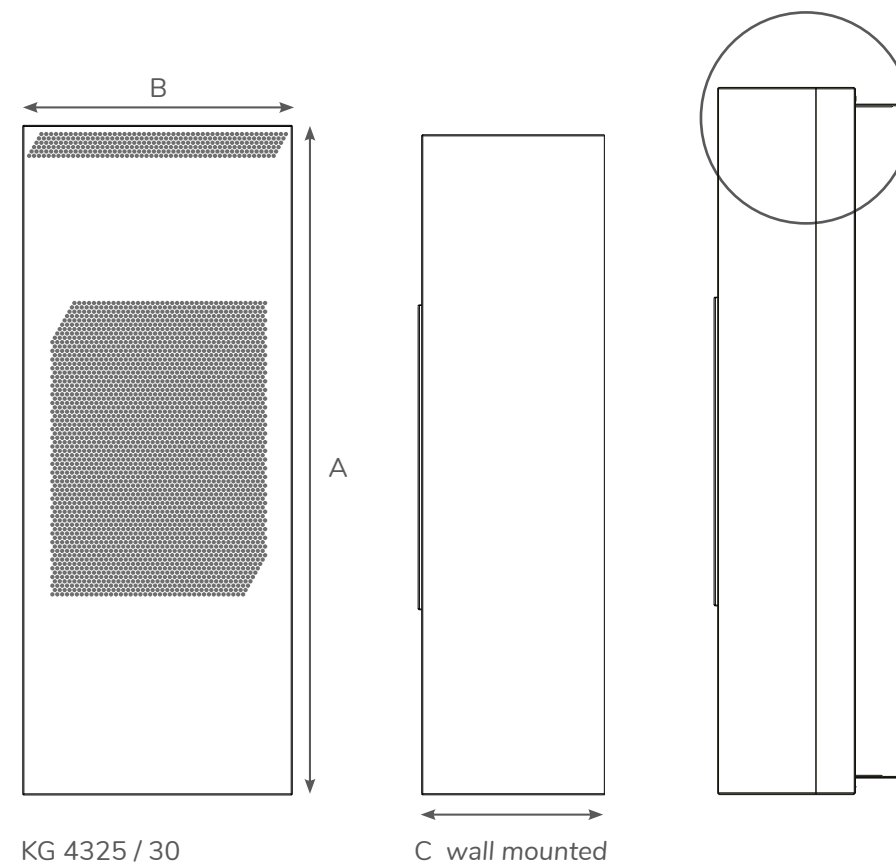
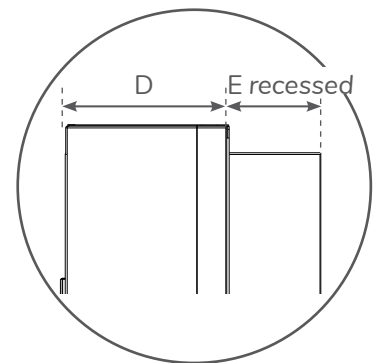
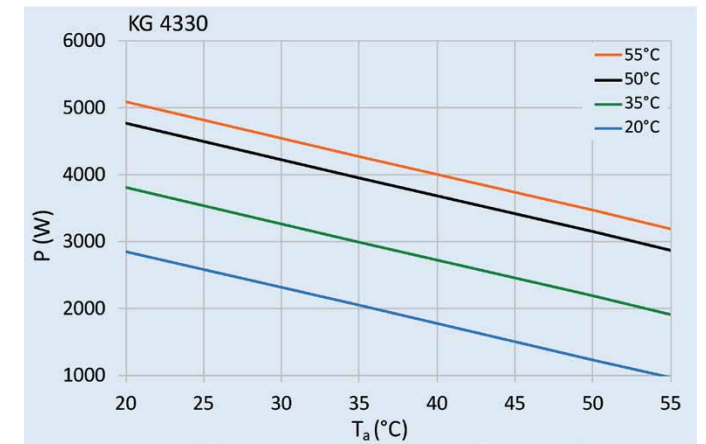
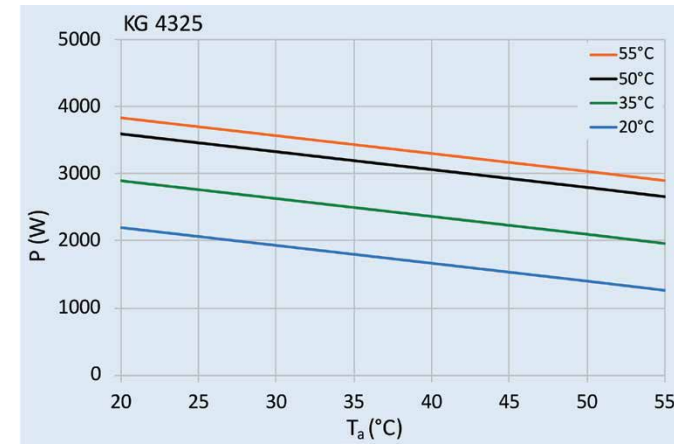



COMPACT INDOOR

The economical all-round solution

KG 4340

- ✓ Cooling capacity: 4 kW
- ✓ Nano coated hydrophobic condenser
- ✓ Various filter options for polluted environments
- ✓ Adjustable electronic controller with display
- ✓ Condensate evaporator optional
- ✓ Mounting template and condensation kit included

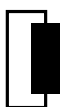

Model	KG 4340-230V	KG 4340-400V
Order no. wall mounting	43400001	43402001
Order no. recess mounting	43400081	43402081
Order no. in stainless steel 304 (V2A)	43XXXX2	
Cooling capacity L35L35 ¹⁾	4.0 / 4.0 kW	
Cooling capacity L35L50 ¹⁾	3.18 / 3.36 kW	
Compressor type	Rotary piston	
Operating temperature range	10°C - 55°C	
Setting range	20°C - 55°C	
System air flow ²⁾	1,050 / 860 m ³ /h	
Unimpeded air flow ²⁾	1,500 / 1,200 m ³ /h	
Mounting	Wall mounted / recessed	
Dimensions A x B x C wall mounted	1,230 x 500 x 340 mm	
Dimensions A x B x C (D+E) recessed	1,295 x 557 x 340 (250+90) mm	
Housing material / colour	Mild steel powder coated / RAL 7035	
Weight	69 kg	72.5 kg
ELECTRICAL DATA		
Voltage / Frequency	230 V ~ 50/60 Hz	380-415 V 50 Hz 3~ 400-460 V 60 Hz 3~
Current L35L35 ¹⁾	8.9 / 10.2 A	2.9 / 2.7 A
Starting current	29.6 A	8.2 / 8.5 A
Max. current ¹⁾	14.2 A	4.6 / 4.4 A
Nominal power L35L35 ¹⁾	1.88 / 2.31 kW	1.91 / 2.33 kW
Max. power	2.40 / 3.72 kW	2.43 / 3.30 kW
Fuse rating	20 A (T)	3 x 6 A (T)
Connection	Terminal block	
Ingress Protection	IP 54	
Certification	CE, cURus, cULus	

¹⁾ Values for 50/60 Hz

²⁾ Ambient / enclosure

Various filter options and other accessories on page 62

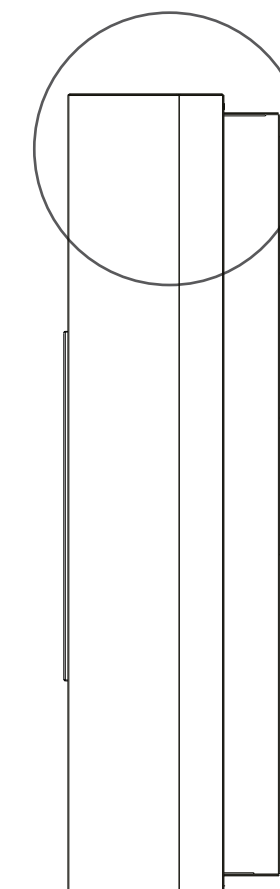
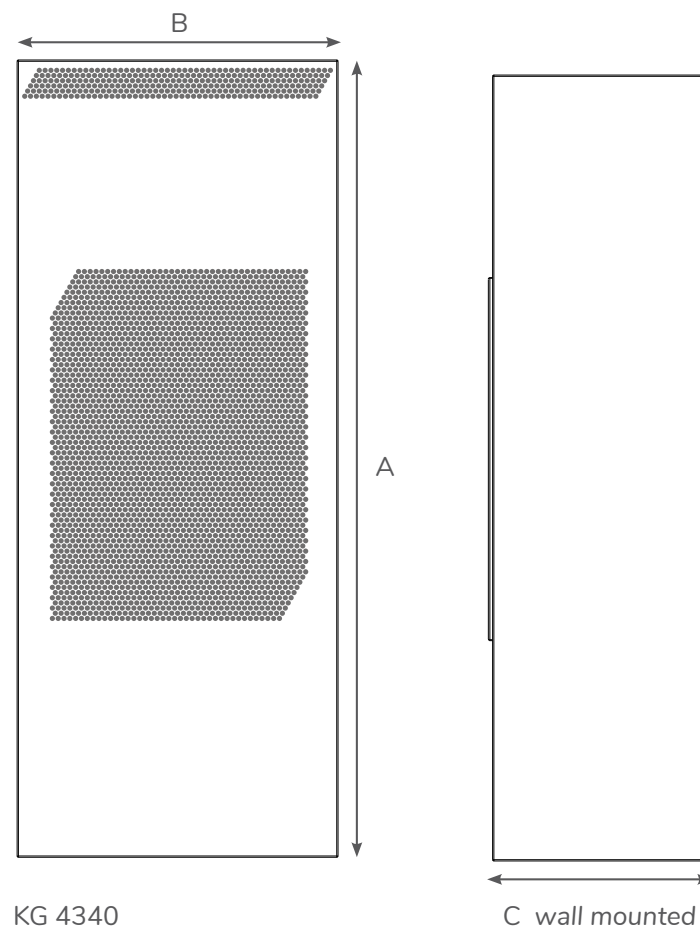
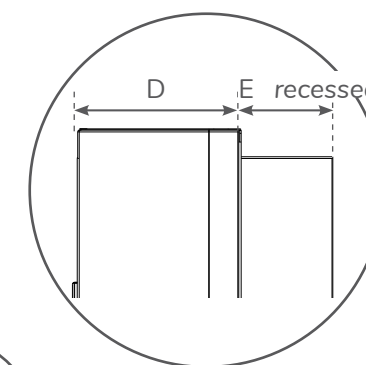
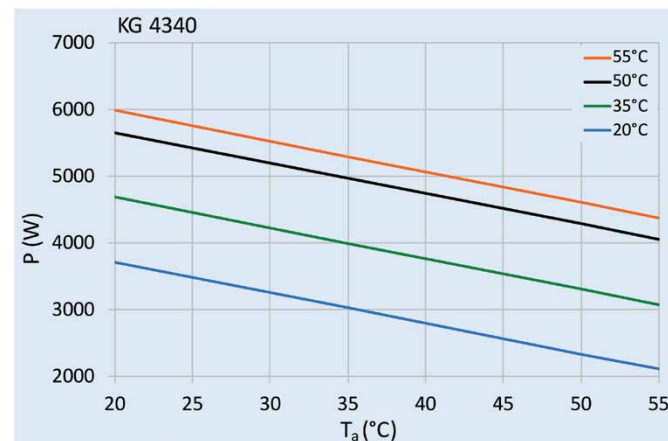

COMPACT INDOOR accessories

Order number	Description
SP-43040001-O-1	Fibre filter media EU2 for KG-4304/5/8/10, 5 pcs.
SP-43150001-O-1	Fibre filter media EU2 for KG-4315/20, 5 pcs.
SP-43250001-O-1	Fibre filter media EU2 for KG-4325/30/40, 3 pcs.

Only usable with stainless steel filter holder.

Order number	Description
SP-43040001-BF-1	Washable aluminium filter for KG-4304/5/8/10
SP-43150001-BF-1	Washable aluminium filter for KG-4315/20
SP-43250001-BF-1	Washable aluminium filter for KG-4325/30/40

Order number	Description
SP-43040001-BG-1	Stainless steel filter holder incl. filter media for KG-4304/5/8/10
SP-43150001-BG-1	Stainless steel filter holder incl. filter media for KG-4315/20
SP-43250001-BG-1	Stainless steel filter holder incl. filter media for KG-4325/30/40

Order number	Description
3100001	Door contact switch with mounting bracket, 2 x M4 screws

Compatible with the door contact interface of the cooling unit. Prevents the formation of condensation when the enclosure door is open.



By adding a filter to your existing or new COMPACT INDOOR cooling unit, it can easily be used in dusty and oily environments. Fibre or aluminium filters are available to match the various unit sizes.

All filter options are easy to install and to replace.

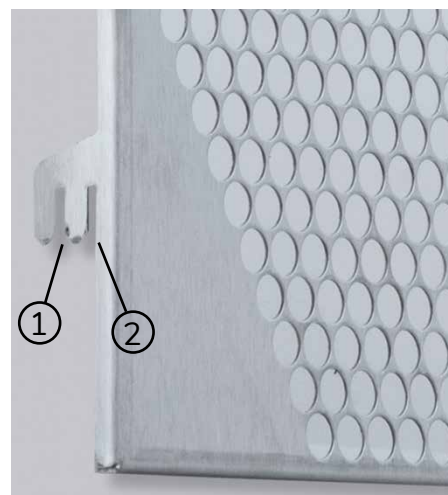

Mounting position 1: Aluminium filter
Mounting position 2: Fibre filter

ENCLOSURE COOLING FOR OUTDOOR & NEMA / TYPE 4X APPLICATIONS

COMPACT OUTDOOR



OPERATING TEMPERATURE RANGE -40°C - 55°C

OPTIONAL ENCLOSURE HEATER

COMPRESSOR HEATER

PROTECTED CONTROLLER AT ENCLOSURE SIDE

PROTECTION CLASS IP 56 IN STAINLESS STEEL TYPE 4X

STANDARD WITH CONDENSATE EVAPORATOR

ENCLOSURE COOLING FOR OUTDOOR USE

COMPACT OUTDOOR enclosure cooling units are designed for wall mounting and have separate internal and ambient air circuits. TYPE 4X units are particularly suitable for harsh outdoor applications.

They can be supplied with an optional enclosure heater and in stainless steel 304 (V2A) or 316 (V4A) housing.

The operating temperature range of -40°C - 55°C guarantees trouble-free operation even at particularly low temperatures or in extreme heat.





COMPACT OUTDOOR / UL Type 4X

For demanding environmental conditions

OC 5704 - OC 5705

- ✓ Cooling capacities: 290 W and 550 W
- ✓ For most outdoor applications suitable without filter
- ✓ Stainless steel models comply to NEMA / UL Type 4X
- ✓ Adjustable electronic controller with display (rear)
- ✓ Condensate evaporator as a standard
- ✓ Mounting template and condensation kit included
- ✓ Maintenance free



Model	OC 5704		OC 5705		
Order number	570400001	570410001	570500001	570510001	570520001
Order no. with enclosure heater	570401001	570411001	570501001	570511001	570521001
Order no. in stainless steel	57XXXX62 in stainless steel 304 (V2A) / 57XXXX64 in stainless steel 316 (V4A)				
Cooling capacity L35L35 ¹⁾	290 / 300 W	300 W	550 / 570 W		550 / 570 W
Cooling capacity L35L50 ¹⁾	250 / 250 W	250 W	445 / 490 W		445 / 490 W
Heating capacity	150 W		400 W		
Compressor type	Rotary piston		Reciprocating		
Operating temperature range	-40°C - 55°C				
Setting range	20°C - 55°C (cooling) / -40°C - 20°C (heating)				
System air flow ²⁾	85 / 85 m³/h		315 / 165 m³/h		
Unimpeded air flow ²⁾	300 / 136 m³/h		850 / 250 m³/h		
Mounting	Wall mounted				
Dimensions A x B x C	480 x 250 x 190 mm		830 x 304 x 270 mm		
Housing material / colour	Mild steel powder coated / RAL 7035				
Weight	15.2 kg	15.4 kg	30 kg	32 kg	
ELECTRICAL DATA					
Voltage / Frequency	230 V ~ 50/60 Hz	120 V ~ 60 Hz	230 V ~ 50/60 Hz	120 V ~ 50/60 Hz	400 / 460 V ~ 50/60 Hz 2~
Current L35L35 ¹⁾	1.3 / 1.3 A	2.3 A	2.5 / 2.6 A	4.8 / 5.0 A	1.5 / 1.3 A
Starting current	8 A		10 A	20 A	5 A
Max. current ¹⁾	1.5 A	2.8 A	3.3 A	6.3 A	1.9 A
Nominal power L35L35 ¹⁾	270 / 270 W	260 W	446 / 475 W	460 / 505 W	
Max. power	325 W	310 W	576 W	690 W	
Fuse rating	2.5 A (T)	5 A (T)	5 A (T)	8 A (T)	2 x 3 A (T)
Connection	Pluggable connection terminal				
Ingress protection	IP 56 / Type 12, 3, 3R, 4, 4X				
Certification	CE, cURus, cULus				
Order no. aluminium filter (optional)	SP-570401201-BF-1		SP-570501201-BF-1		

¹⁾ Values for 50/60 Hz

²⁾ Ambient / enclosure

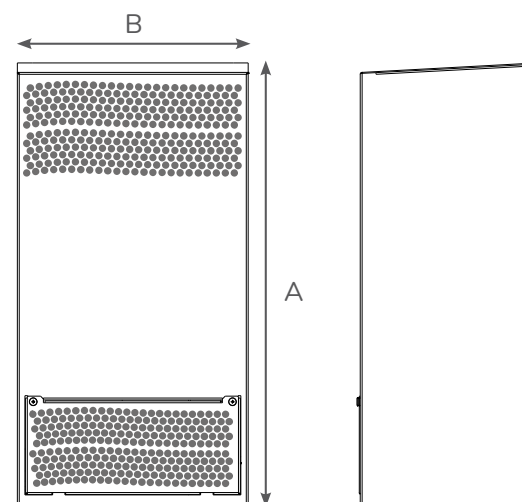
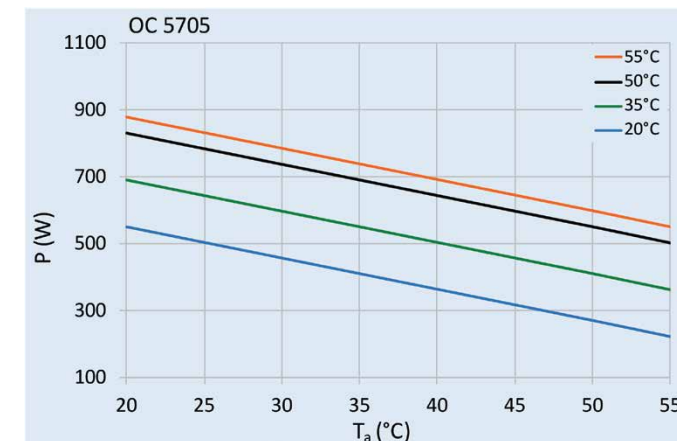
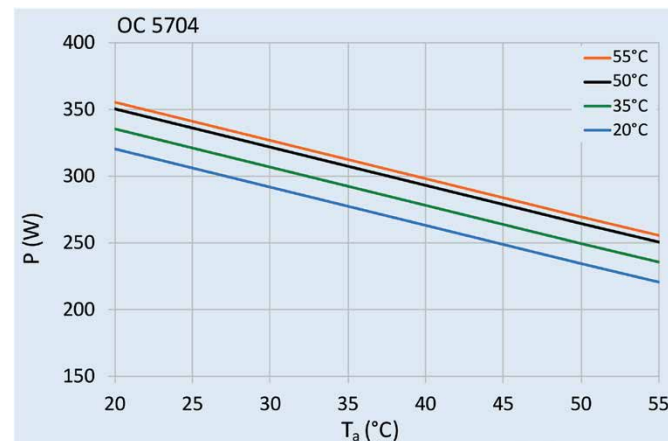

OC 5704

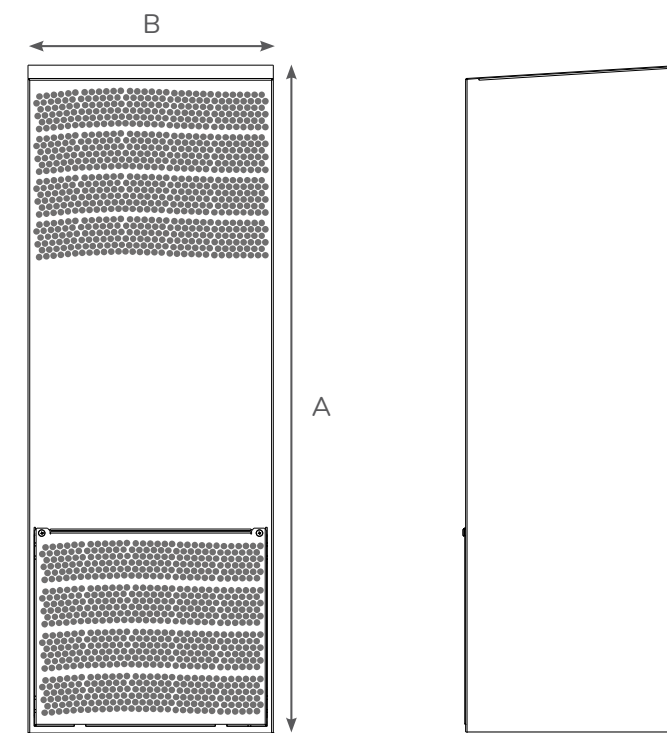

OC 5705



COMPACT OUTDOOR / UL Type 4X

For demanding environmental conditions

OC 5708 - OC 5710

- ✓ Cooling capacities: 750 W and 1 kW
- ✓ For most outdoor applications suitable without filter
- ✓ Stainless steel models comply to NEMA / UL Type 4X
- ✓ Adjustable electronic controller with display (rear)
- ✓ Condensate evaporator as a standard
- ✓ Mounting template and condensation kit included
- ✓ Maintenance free



Model	OC 5708			OC 5710		
Order number	570800001	570810001	570820001	571000001	571010001	571020001
Order no. with enclosure heater	570801001	570811001	570821001	571001001	571011001	571021001
Order no. in stainless steel	57XXXX62 in stainless steel 304 (V2A) / 57XXXX64 in stainless steel 316 (V4A)					
Cooling capacity L35L35 ¹⁾	750 / 830 W			1.0 / 1.08 kW		
Cooling capacity L35L50 ¹⁾	650 / 695 W			660 / 720 W		
Heating capacity	400 W					
Compressor type	Reciprocating					
Operating temperature range	-40°C - 55°C					
Setting range	20°C - 55°C (cooling) / -40°C - 20°C (heating)					
System air flow ²⁾	315 / 165 m³/h			320 / 375 m³/h		
Unimpeded air flow ²⁾	850 / 250 m³/h			850 / 550 m³/h		
Mounting	Wall mounted					
Dimensions A x B x C	830 x 304 x 270 mm			900 x 304 x 270 mm		
Housing material / colour	Mild steel powder coated / RAL 7035					
Weight	30 kg	32 kg	35 kg	38 kg	40 kg	39.5 kg
ELECTRICAL DATA						
Voltage / Frequency	230 V ~ 50/60 Hz	120 V ~ 50/60 Hz	400 / 460 V ~ 50/60 Hz 2~	230 V ~ 50/60 Hz	120 V ~ 50/60 Hz	400 / 460 V ~ 50/60 Hz 2~
Current L35L35 ¹⁾	3.1 / 2.9 A	6.0 / 5.6 A	1.8 / 1.5 A	4.0 / 4.2 A	8.0 / 8.4 A	2.1 / 2.3 A
Starting current	10 A	20 A	6 A	16 A	32 A	9.2 / 8.0 A
Max. current	3.5 A	7 A	1.9 A	5.4 A	9 A	2.5 A
Nominal power L35L35 ¹⁾	565 / 575 W			770 / 830 W		
Max. power	740 W			1.15 kW		
Fuse rating	5 A (T)	16 A (T)	2 x 3 A (T)	9 A (T)	18 A (T)	5 A (T)
Connection	Pluggable connection terminal					
Ingress protection	IP 56 / Type 12, 3, 3R, 4, 4X					
Certification	CE, cURus, cULus					
Order no. aluminium filter (optional)	SP-570801201-BF-1			SP-571001201-BF-1		

¹⁾ Values for 50/60 Hz

²⁾ Ambient / enclosure

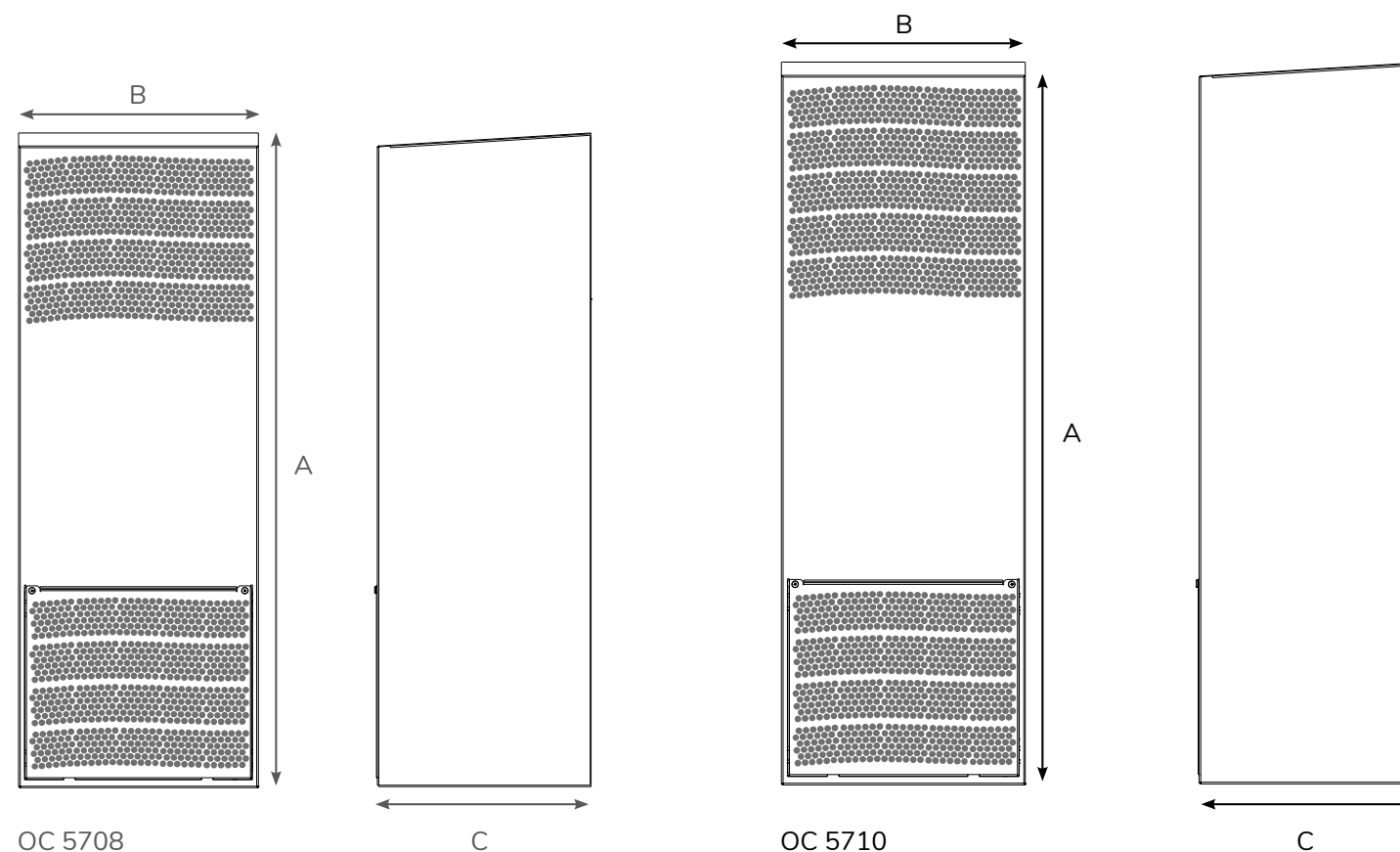
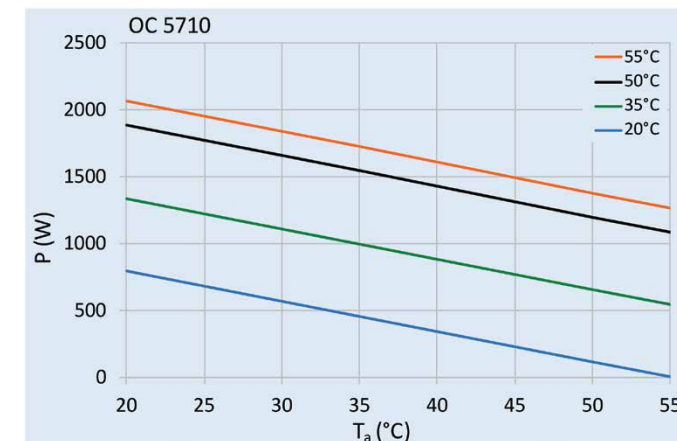
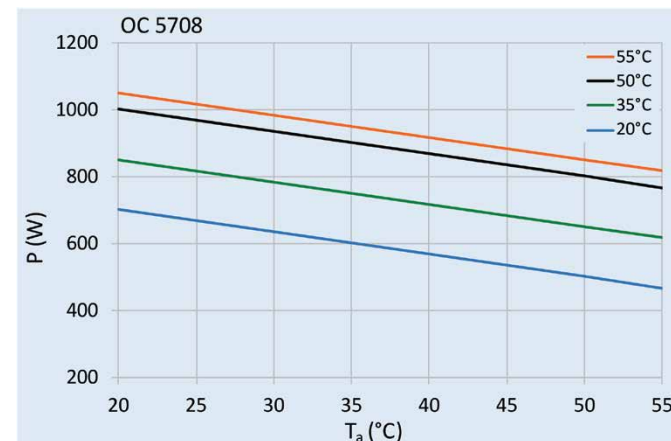



COMPACT OUTDOOR / UL Type 4X

For demanding environmental conditions

OC 5715 - OC 5720

- ✓ Cooling capacities: 1.5 kW and 2 kW
- ✓ For most outdoor applications suitable without filter
- ✓ Stainless steel models comply to NEMA / UL Type 4X
- ✓ Adjustable electronic controller with display (rear)
- ✓ Condensate evaporator as a standard
- ✓ Mounting template and condensation kit included
- ✓ Maintenance free



Model	OC 5715			OC 5720		
Order number	571500001	571510001	571520001	572000001	572010001	572020001
Order no. with enclosure heater	571501001	571511001	571521001	572001001	572011001	572021001
Order no. in stainless steel	57XXXX62 in stainless steel 304 (V2A) / 57XXXX64 in stainless steel 316 (V4A)					
Cooling capacity L35L35 ¹⁾	1.5 / 1.5 kW			2.0 / 2.0 kW		
Cooling capacity L35L50 ¹⁾	1.25 / 1.28 kW			1.6 / 1.6 kW		
Heating capacity	1,000 W					
Compressor type	Reciprocating					
Operating temperature range	-40°C - 55°C					
Setting range	20°C - 55°C (cooling) / -40°C - 20°C (heating)					
System air flow ²⁾	655 / 400 m ³ /h			655 / 400 m ³ /h		
Unimpeded air flow ²⁾	1,200 / 550 m ³ /h			1,200 / 850 m ³ /h		
Mounting	Wall mounted					
Dimensions A x B x C	1,150 x 395 x 270 mm					
Housing material / colour	Mild steel powder coated / RAL 7035					
Weight	42 kg	50 kg	49 kg	52 kg	49 kg	
ELECTRICAL DATA						
Voltage / Frequency	230 V ~ 50/60 Hz	120 V ~ 50/60 Hz	400 / 460 V ~ 50/60 Hz 2~	230 V ~ 50/60 Hz	120 V ~ 50/60 Hz	380-415 V 50 Hz 3~ 400-460 V 60 Hz 3~
Current L35L35 ¹⁾	6.4 / 5.4 A	10.8 / 10.8 A	3.7 / 2.7 A	6.2 / 7.2 A	12.4 / 14.4 A	3.0 / 2.5 A
Starting current	16 A	32 A	8 A	16 A	32 A	8.5 A
Max. current ¹⁾	6.8 / 7.1 A	12.8 / 14.2 A	3.9 / 3.6 A	7.9 A	17.2 A	3.2 A
Nominal power L35L35 ¹⁾	1.1 / 1.07 kW			1.43 / 1.61 kW		1.36 / 1.60 kW
Max. power	1.45 kW			1.93 kW		1.58 / 1.76 kW
Fuse rating	12 A (T)	25 A (T)	6 A (T)	13 A (T)	28 A (T)	3 x 6 A (T)
Connection	Pluggable connection terminal					
Ingress protection	IP 56 / Type 12, 3, 3R, 4, 4X					
Certification	CE, cURus, cULus					
Order no. aluminium filter (optional)	SP-571501201-BF-1			SP-572001201-BF-1		

¹⁾ Values for 50/60 Hz

²⁾ Ambient / enclosure

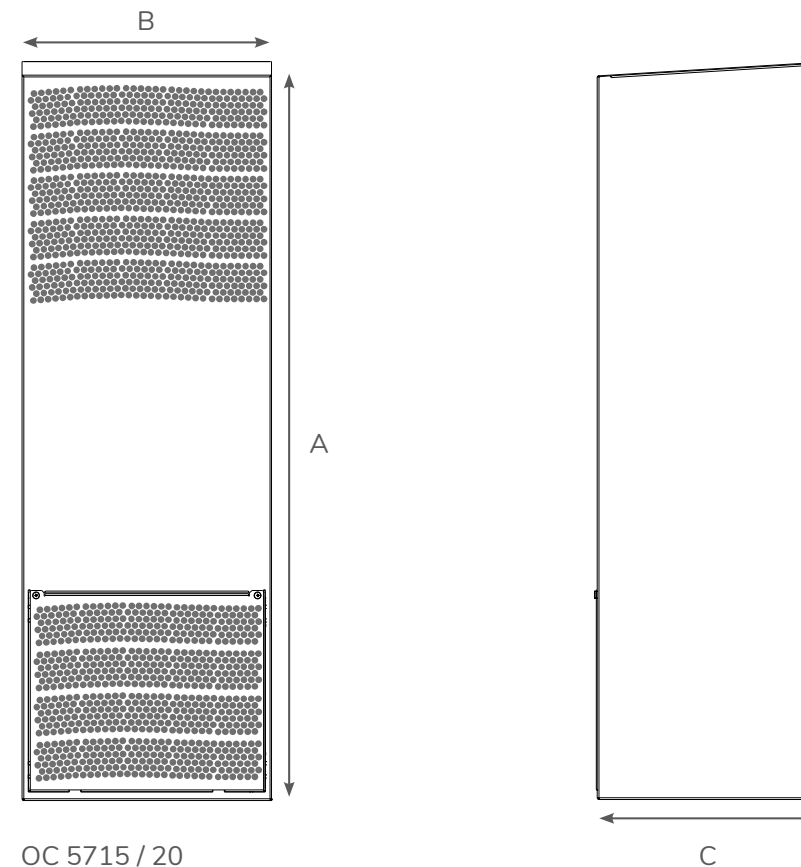
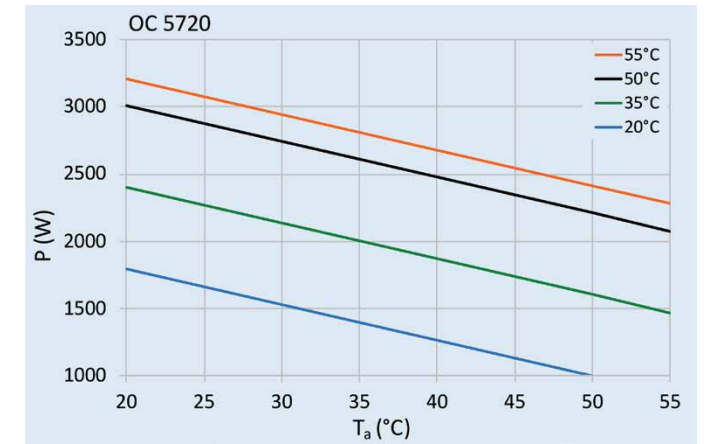
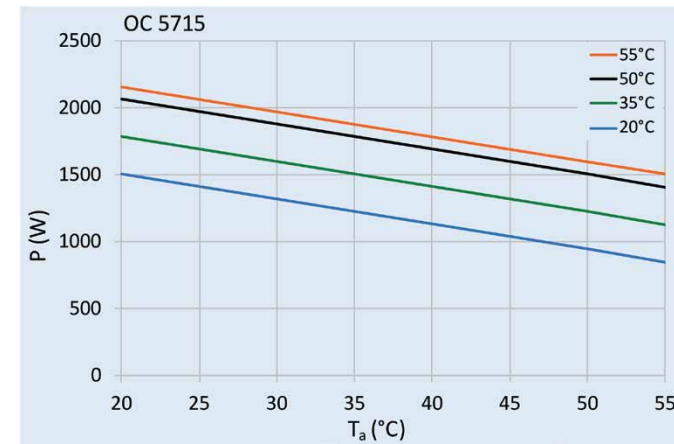



COMPACT OUTDOOR / UL Type 4X

For demanding environmental conditions

OC 5726 - OC 5731

- ✓ Cooling capacities: 2.5 kW and 3 kW
- ✓ For most outdoor applications suitable without filter
- ✓ Stainless steel models comply to NEMA / UL Type 4X
- ✓ Adjustable electronic controller with display (rear)
- ✓ Condensate evaporator as a standard
- ✓ Mounting template and condensation kit included
- ✓ Maintenance free



Model	OC 5726			OC 5731		
Order number	572600001	572610001	572620001	573100001	573110001	573120001
Order no. with enclosure heater	572601001	572611001	572621001	573101001	573111001	573121001
Order no. in stainless steel	57XXXX62 in stainless steel 304 (V2A) / 57XXXX64 in stainless steel 316 (V4A)					
Cooling capacity L35L35 ¹⁾	2.5 / 2.5 kW			3.0 / 3.0 kW		
Cooling capacity L35L50 ¹⁾	1.97 / 2.04 kW			2.38 / 2.51 kW		
Heating capacity	1,500 W					
Compressor type	Rotary piston					
Operating temperature range	-40°C - 55°C					
Setting range	20°C - 55°C (cooling) / -40°C - 20°C (heating)					
System air flow ²⁾	765 / 950 m³/h					
Unimpeded air flow ²⁾	1,200 / 1,200 m³/h					
Mounting	Wall mounted					
Dimensions A x B x C	1,550 x 457 x 355 mm					
Housing material / colour	Mild steel powder coated / RAL 7035					
Weight	78 kg	80 kg	80 kg	75.3 kg	78 kg	
ELECTRICAL DATA						
Voltage / Frequency	230 V ~ 50/60 Hz	120 V ~ 50/60 Hz	400 / 460 V ~ 50/60 Hz 2~	230 V ~ 50/60 Hz	120 V ~ 50/60 Hz	380-415 V 50 Hz 3~ 400-460 V 60 Hz 3~
Current L35L35 ¹⁾	4.4 / 5.3 A	8.7 / 10.2 A	2.9 / 2.6 A	5.8 / 7.4 A	11.6 / 15.3 A	2.1 / 2.3 A
Starting current	22.5 A	45 A	6.1 / 6.8 A	30 A	49 A	7.6 / 8.1 A
Max. current ¹⁾	7.1 A	14.2 A	3.6 / 3.2 A	9.9 A	18.4 A	3.3 / 3.5 A
Nominal power L35L35 ¹⁾	1.03 / 1.16 kW		0.94 / 1.18 kW	1.32 / 1.67 kW		1.34 / 1.70 kW
Max. power	1.30 / 1.64 kW			1.65 / 2.20 kW		1.66 / 2.10 kW
Fuse rating	16 A (T)	20 A (T)	2 x 9 A (T)	16 A (T)	20 A (T)	3 x 6 A (T)
Connection	Pluggable connection terminal					
Ingress protection	IP 56 / Type 12, 3, 3R, 4, 4X					
Certification	CE, cURus, cULus					
Order no. aluminium filter (optional)	SP-572601201-BF-1			SP-573101201-BF-1		

¹⁾ Values for 50/60 Hz

²⁾ Ambient / enclosure

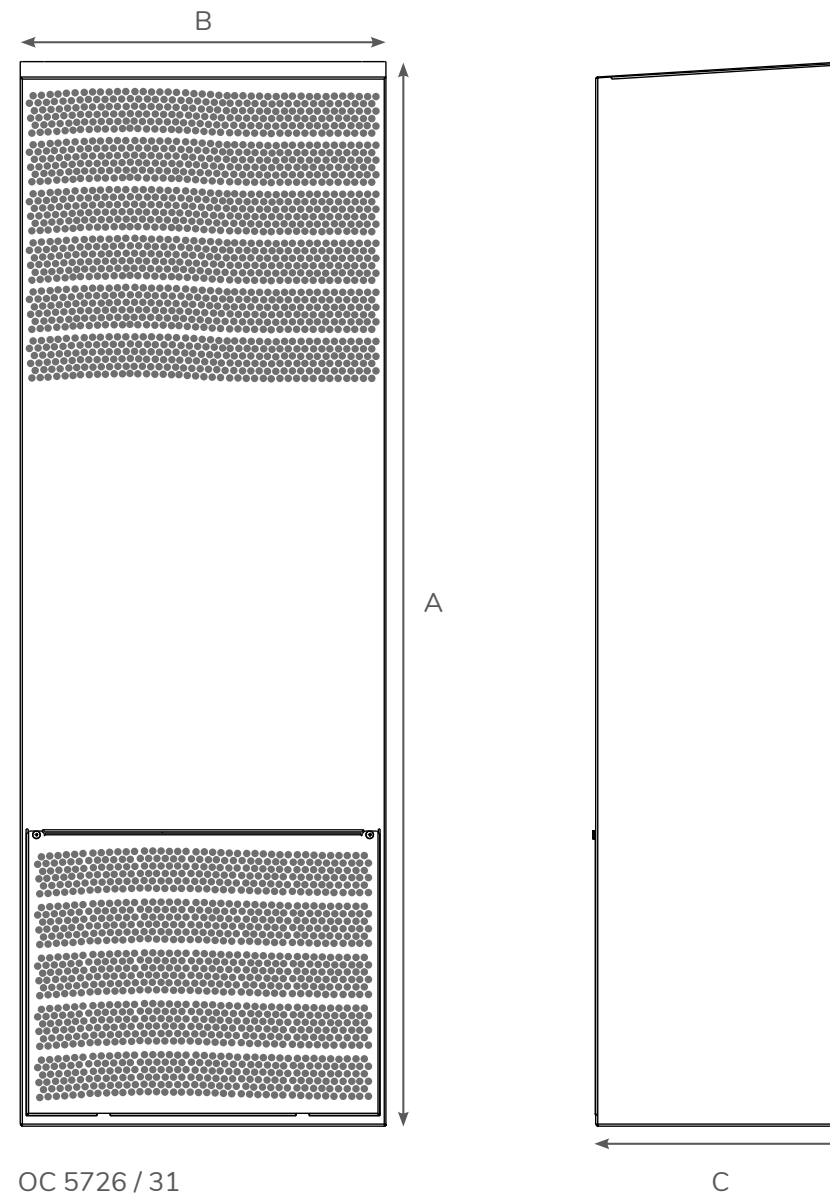
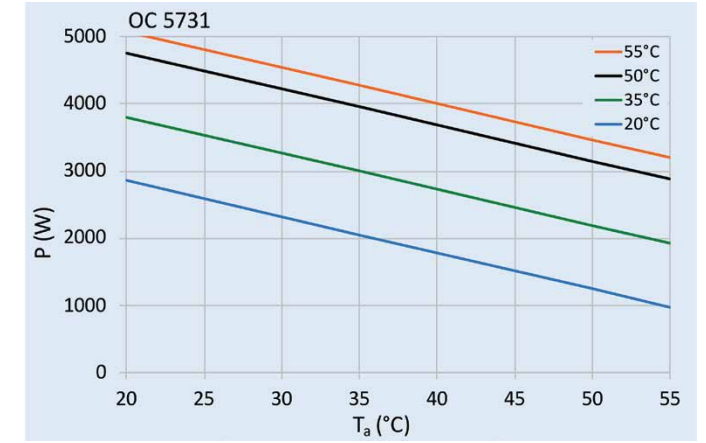
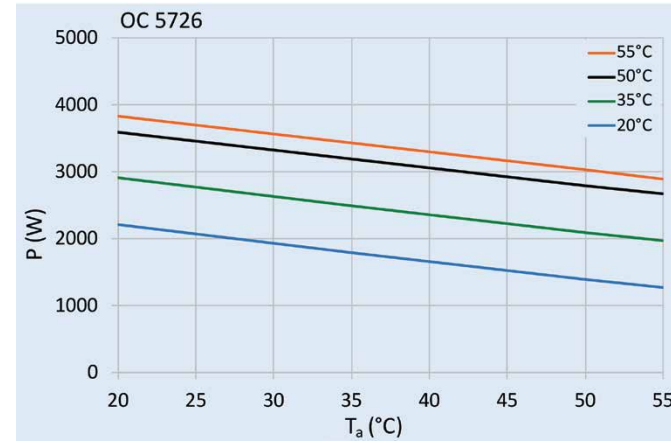

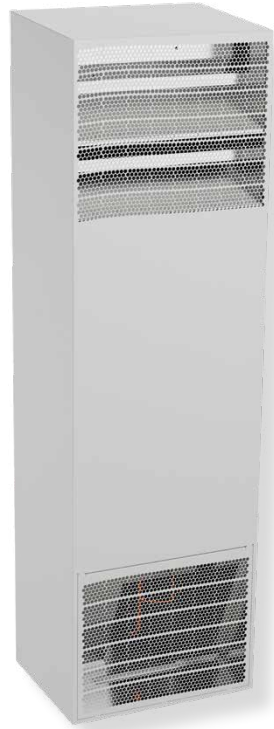

COMPACT OUTDOOR / UL Type 4X

For demanding environmental conditions

OC 5741 - OC 8762

- ✓ Cooling capacities: 4 kW and 6 kW
- ✓ For most outdoor applications suitable without filter
- ✓ Stainless steel models comply to NEMA / UL Type 4X
- ✓ Adjustable electronic controller with display (rear)
- ✓ Condensate evaporator as a standard
- ✓ Mounting template and condensation kit included
- ✓ Maintenance free



Model	OC 5741		OC 8762
Order number	574100001	574120001	876220201
Order no. with enclosure heater	574101001	574121001	876221201
Order no. in stainless steel	57XXXX62 in stainless steel 304 (V2A) / 57XXXX64 in stainless steel 316 (V4A)		87622082 / 87622084
Cooling capacity L35L35 ¹⁾	4.0 / 4.0 kW	4.1 / 4.1 kW	5.8 / 6.2 kW
Cooling capacity L35L50 ¹⁾	3.18 / 3.36 kW	3.25 / 3.40 kW	4.8 / 5.4 kW
Heating capacity	2,000 W		
Compressor type	Rotary piston		Scroll
Operating temperature range	-40°C - 55°C		
Setting range	20°C - 55°C (cooling) / -40°C - 20°C (heating)		
System air flow ²⁾	990 / 950 m³/h		935 / 640 m³/h
Unimpeded air flow ²⁾	1,500 / 1,200 m³/h		1,480 / 880 m³/h
Mounting	Wall mounted		
Dimensions A x B x C	1,550 x 457 x 355 mm		1,135 x 455 x 390 mm
Housing material / colour	Mild steel powder coated / RAL 7035		
Weight	82 kg	83 kg	91 kg
ELECTRICAL DATA			
Voltage / Frequency	230 V ~ 50/60 Hz		380-415 V 50 Hz 3~ 400-460 V 60 Hz 3~
Current L35L35 ¹⁾	8.9 / 11 A	3.8 / 3.9 A	5.9 / 6.2 A
Starting current	50 A	8.2 / 8.5 A	69 A
Max. current ¹⁾	13.7 A	5 A	9.0 A / 9.8 A
Nominal power L35L35 ¹⁾	2.0 / 2.5 kW	2.0 / 2.4 kW	3.0 / 3.8 kW
Max. power	2.4 / 3.27 kW	3.3 kW	5.7 / 6.3 kW
Fuse rating	20 A (T)	3 x 8 A (T)	3 x 18 A (T)
Connection	Pluggable connection terminal		4 pole connector for power 5 pole connector for signals
Ingress protection	IP 56 / Type 12, 3, 3R, 4, 4X		
Certification	CE, cURus, cULus		
Order no. aluminium filter (optional)	SP-574101201-BF-1		-

¹⁾ Values for 50/60 Hz

²⁾ Ambient / enclosure

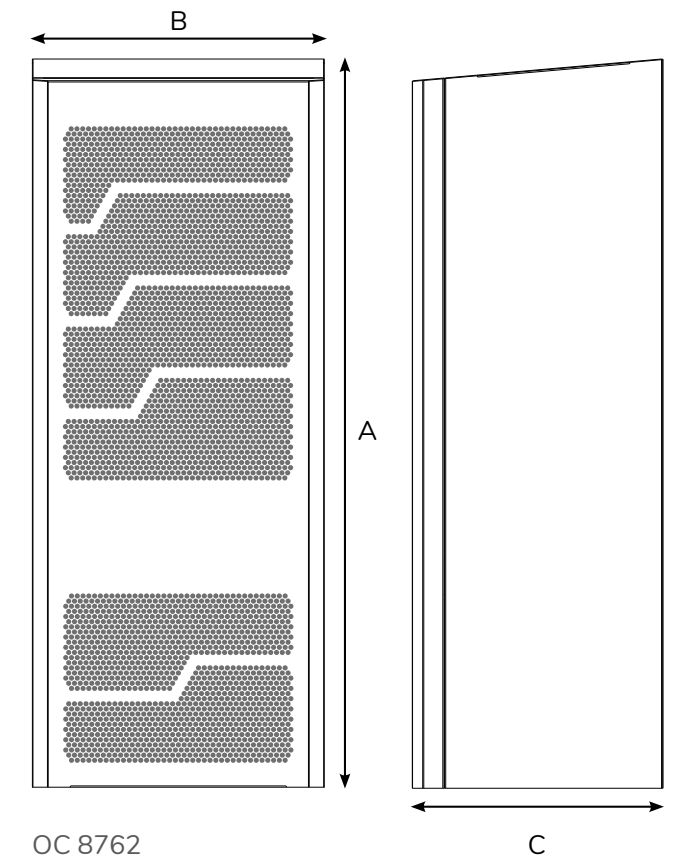
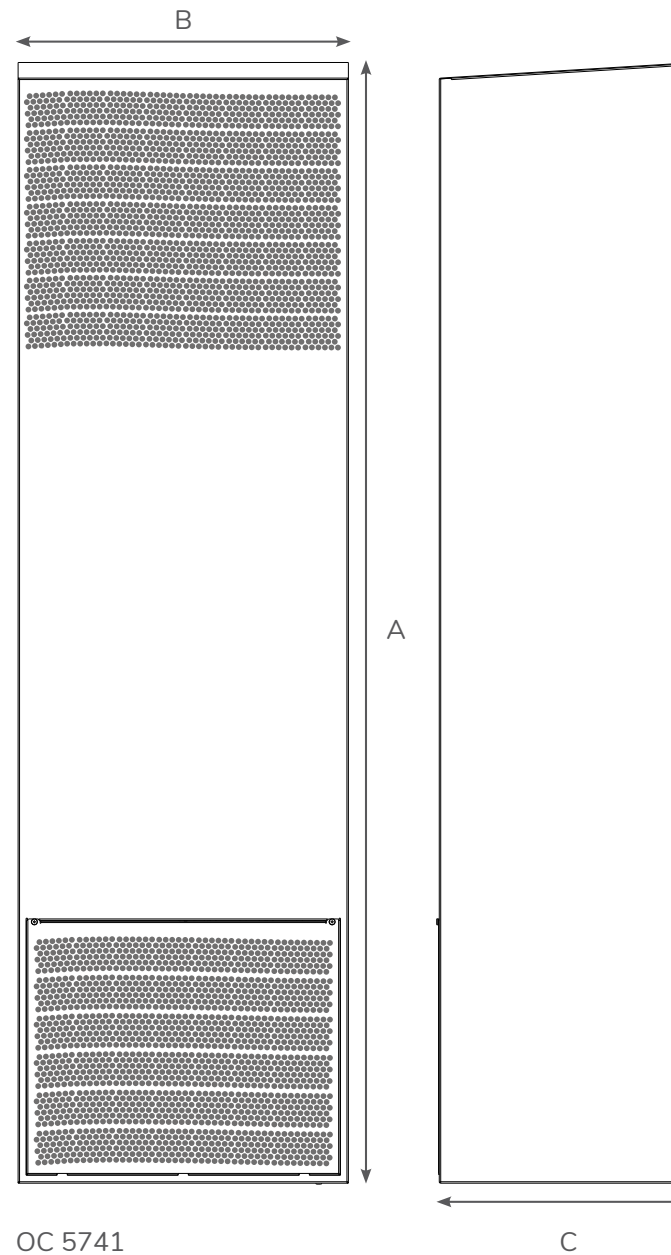
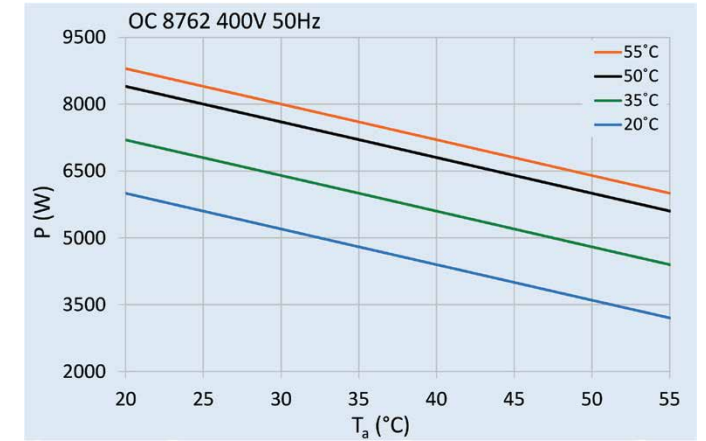
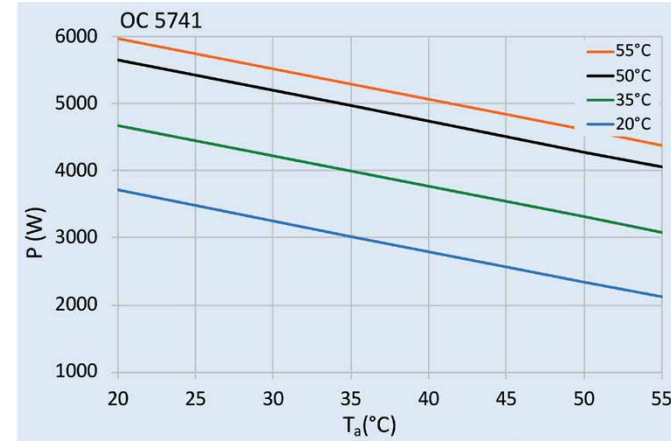

PROTECTION OF YOUR ELECTRONICS IN AGRESSIVE AMBIENT CONDITIONS

SOLITHERM PROTEC

STAINLESS STEEL 316 (V4A)
HOUSING

COATED CONDENSER

ALUMINIUM FILTER

PROTECTED COPPER PIPES
AMBIENT SIDE



PROTECTED CONTROLLER
AT ENCLOSURE SIDE

RS 485 MODBUS
INTERFACE

PROTECTION CLASS
IP 56 / TYPE 3R, 4X

CONDENSATE
EVAPORATOR IP 66

ENCLOSURE COOLING FOR CORROSIVE ENVIRONMENTS

SOLITHERM PROTEC enclosure cooling units are designed for use in extremely harsh environments, such as the petrochemical industry, water treatment plants and port areas.

The coated condenser and coated internal pipes on the ambient side as well as a stainless steel housing made of V4A (AISI 316) ensure enhanced protection against chemicals and salt fog.

The protection classes of IP 56, NEMA / Type 12, 3R, 4X ensure, that your electronics are always kept to the required temperature in any corrosive environment.





SOLITHERM PROTEC

For highly corrosive environments

OC 8706 - OC 8712

- ✓ Cooling capacities: 600 W and 1.1 kW
- ✓ Stainless steel AISI 316 (V4A) housing
- ✓ Adjustable controller with display
- ✓ Protection class IP 56, NEMA / Type 3R, 4X
- ✓ Codensate evaporator IP 66
- ✓ Coated condenser
- ✓ Protected internal copper pipes ambient side
- ✓ RS 485 MODBUS interface



Model	OC 8706		OC 8712		
Order number	87060584	87061584	87120584	87121584	87122584
Cooling capacity L35L35 ¹⁾	600 / 630 W	630 / 665 W	1.12 / 1.20 kW		
Cooling capacity L35L50 ¹⁾	430 / 450 W	510 / 530 W	800 / 840 W		
Heating capacity	150 W		400 W		
Compressor type	Rotary piston		Reciprocating		
Operating temperature range	-40°C - 60°C ²⁾		-40°C - 60°C		
Setting range	20°C - 50°C				
System air flow ³⁾	235 / 408 m³/h		280 / 300 m³/h		
Unimpeded air flow ³⁾	115 / 180 m³/h		550 / 470 m³/h		
Mounting	Wall mounted				
Dimensions A x B x C	380 x 250 x 250 mm		585 x 305 x 305 mm		
Housing material	Stainless steel AISI 316 (V4A)				
Weight	15.7 kg	31 kg	34.5 kg	35 kg	
ELECTRICAL DATA					
Voltage / Frequency	230 V ~ 50/60 Hz	120 V ~ 50/60 Hz	230 V ~ 50/60 Hz	120 V ~ 50/60 Hz	400 / 460 V ~ 50/60 Hz 2~
Current L35L35 ¹⁾	2.0 / 1.9 A	4.9 / 3.9 A	3.2 / 3.6 A	6.5 / 7.1 A	1.9 / 1.8 A
Starting current	6.0 A	13.0 A	15 A	30 A	8.6 A
Max. current	2.3 A	5.1 A	4.6 A	9.2 A	2.7 A
Nominal power L35L35 ¹⁾	411 / 415 W	420 / 435 W	700 / 800 W		
Max. power	540 W	570 W	1.05 kW		
Fuse rating	15 A (T)				
Connection	4 - pole connector for power, 5 - pole connector for signals, 3 - pole connector for RS 485 Modbus				
Ingress protection	IP 56 / Type 12, 3, 3R, 4X				
Certification	CE, UL(ACVS), cULus				

¹⁾ Values for 50/60 Hz

²⁾ Operating temperature range according to UL -40°C - 55°C

³⁾ Ambient / enclosure

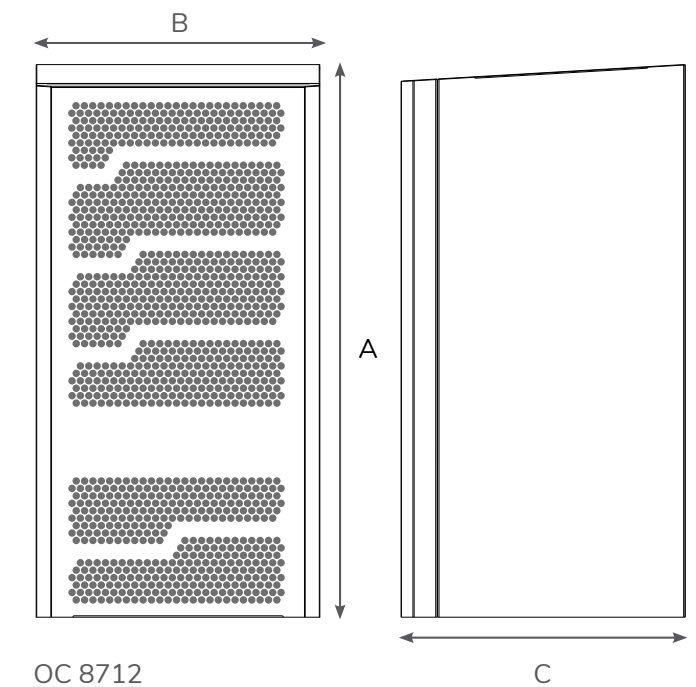
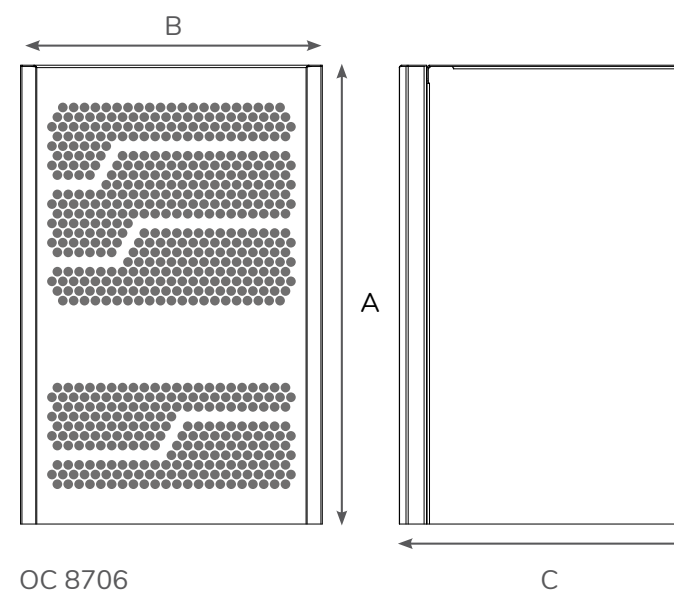
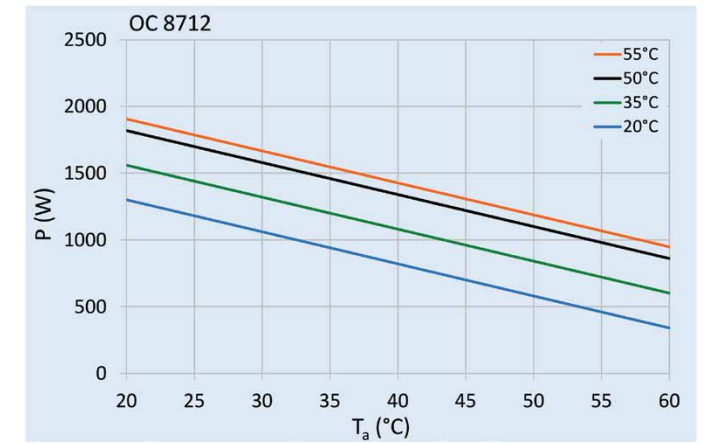
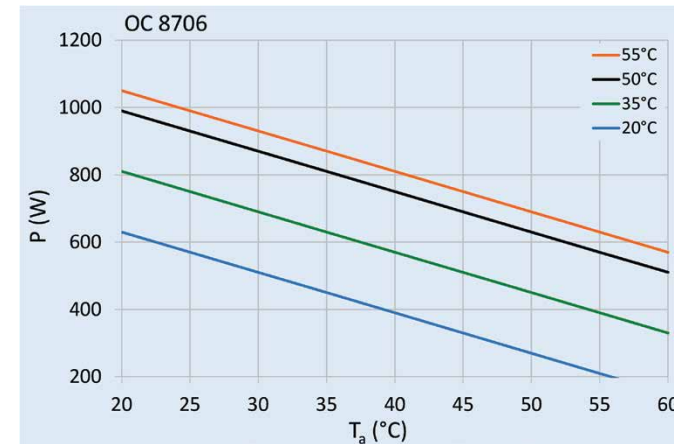



SOLITHERM PROTEC

For highly corrosive environments

OC 8720 - OC 8740 - OC 8762

- ✓ Cooling capacities: 2 kW, 4 kW and 6 kW
- ✓ Stainless steel AISI 316 (V4A) housing
- ✓ Adjustable controller with display
- ✓ Protection class IP 56, NEMA / Type 3R, 4X
- ✓ Codensate evaporator IP 66
- ✓ Coated condenser
- ✓ Protected internal copper pipes ambient side
- ✓ RS 485 MODBUS interface



Model	OC 8720			OC 8740		OC 8762
Order number	87200584	87201584	87202584	87400584	87402584	87622584
Cooling capacity L35L35 ¹⁾	2.0 / 2.1 kW			3.9 / 4.3 kW		6.0 / 6.2 kW
Cooling capacity L35L50 ¹⁾	1.85 / 1.9 kW			3.3 / 3.4 kW		4.8 / 5.4 kW
Heating capacity	1,000 W			2,000 W		
Compressor type	Reciprocating					Scroll
Operating temperature range	-40°C - 60°C					-40°C - 55°C
Setting range	20°C - 50°C					
System air flow ²⁾	440 / 360 m³/h			1,085 / 870 m³/h		935 / 1,080 m³/h
Unimpeded air flow ²⁾	680 / 520 m³/h			1,480 / 1,480 m³/h		1,480 / 1,480 m³/h
Mounting	Wall mounted					
Dimensions A x B x C	890 x 395 x 305 mm			1,040 x 455 x 370 mm		1,135 x 455 x 390 mm
Housing material	Stainless steel AISI 316 (V4A)					
Weight	45.4 kg	52.5 kg	52.2 kg	65 kg		85 kg
ELECTRICAL DATA						
Voltage / Frequency	230 V ~ 50/60 Hz	120 V ~ 50/60 Hz	400 / 460 V ~ 50/60 Hz 2~	230 V ~ 50/60 Hz	380-415V 50 Hz 3~ 400-460V 60 Hz 3~	380-415V 50 Hz 3~ 400-460V 60 Hz 3~
Current L35L35 ¹⁾	4.4 / 5.7 A	8.8 / 11.3 A	2.5 / 2.8 A	9.5 / 12.4 A	3.6 / 4.0 A	5.9 / 6.2 A
Starting current ¹⁾	16 A	32 A	12 A	50 A	19 A	57 / 44 A
Max. current	7.5 A	14.5 A	4.3 A	14.5 A	4.8 A	9.8 A
Nominal power L35L35 ¹⁾	1.0 / 1.2 kW			1.85 / 2.40 kW	1.8 / 2.4 kW	3.0 / 3.8 kW
Max. power	1.65 kW			3.4 kW	3.2 kW	6.3 kW
Fuse rating	15 A (T)	20 A (T)	15 A (T)	20 A (T)	15 A (T)	15 A (T)
Connection	4 - pole connector for power, 5 - pole connector for signals, 3 - pole connector for RS 485 Modbus					
Ingress protection	IP 56 / Type 12, 3, 3R, 4X					
Certification	CE, UL(ACVS), cULus					

¹⁾ Values for 50/60 Hz

²⁾ Ambient / enclosure

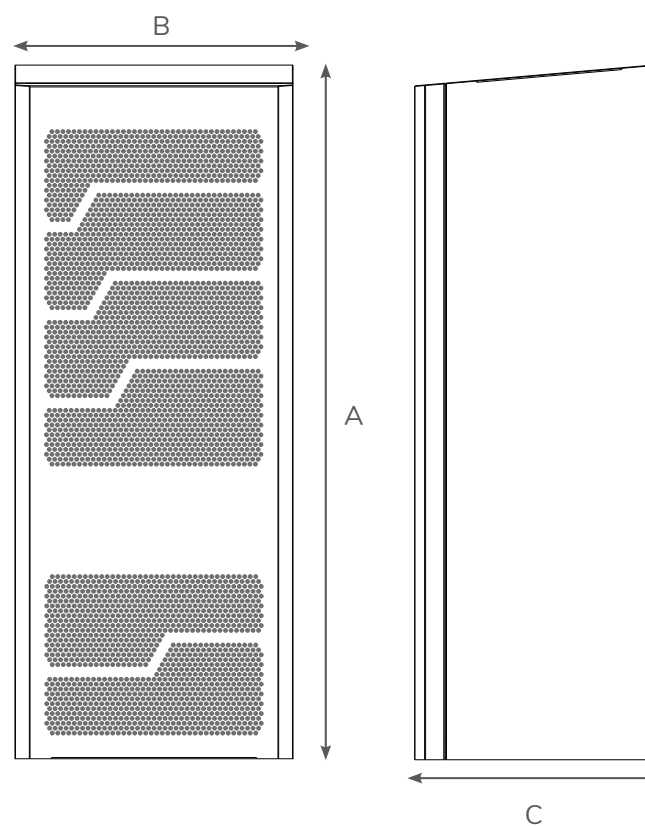
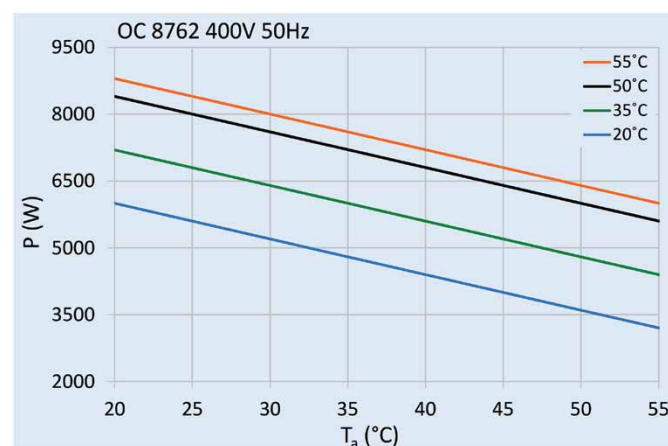
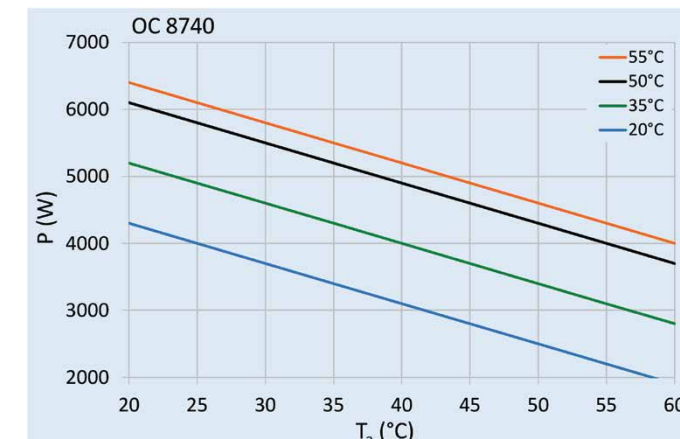
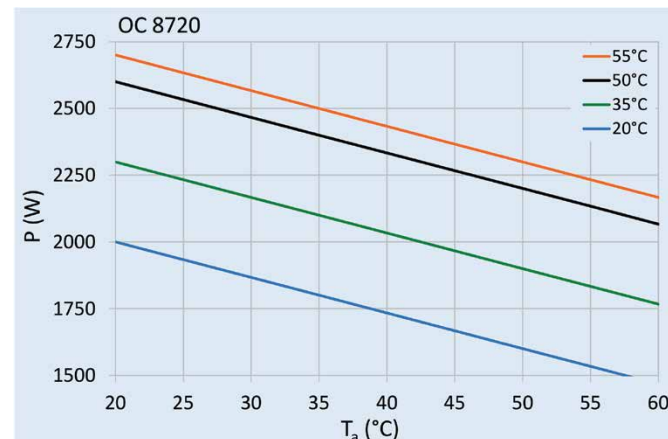

ENCLOSURE COOLING WITHOUT REFRIGERANT

SOLITHERM PELTIER



WALL MOUNTED / RECESSED

OPERATING TEMPERATURE
RANGE -20°C - 70°C

AMBIENT FAN IP 68

FOR INDOOR AND
OUTDOOR APPLICATIONS

WITH AC AND DC
VOLTAGE AVAILABLE

PROTECTION CLASS IP 66
NEMA / TYPE 4X

EFFICIENT ENCLOSURE COOLING WITH PELTIER TECHNOLOGY

SOLITHERM PELTIER cooling units are based on the so-called Peltier effect.

When DC voltage is applied, Peltier elements generate a temperature difference which in combination with surface-enlarging heat sinks and forced ventilation, causes cooling inside the enclosure. The heat is dissipated into the environment via a separate ambient heat sink.

SOLITHERM PELTIER units do not require a refrigerant. They have no compressor and no pressure circuit and can thus be installed in almost any position. Condensate management must be considered separately.

Peltier cooling units withstand the most extreme environments and work reliably even in very dusty and oily conditions and at temperatures between -20°C and 70°C.

SOLITHERM PELTIER cooling units with ATEX zone classifications can be used for hazardous applications.





SOLITHERM PELTIER

Thermo electric cooling units for DC voltage

TG 3030 - TG 3035

- ✓ Cooling capacity: 30 W
- ✓ For indoor and outdoor applications
- ✓ Can be mounted in any position ¹⁾
- ✓ NEMA / Type 4X rated
- ✓ Ingress protection IP 66
- ✓ Maintenance free



Model	TG 3030	TG 3035
Order no. recess mounting	3030303	3035303
Order no. wall mounting (with frame)	3030305	3035305
Order no. in stainless steel 316 (V4A)	303030X4	303530X4
Cooling capacity L35L35	30 W	
Operating temperature range ²⁾	-20°C - 70°C	
System air flow ³⁾	39 / 20 m ³ /h	39 / 20 m ³ /h
Unimpeded air flow ³⁾	75 / 62 m ³ /h	75 / 62 m ³ /h
Mounting	Recessed / wall mounted (with frame)	
Dimensions A x B x C (D+E) recessed	110 x 154 x 125 (61+64) mm	110 x 154 x 129 (62+67) mm
Dimensions A x B x C wall mounted	212 x 158 x 132 mm	
Housing material	Stainless steel 304 (V2A)	
Weight (recessed / wall mounted)	1.8 / 2.6 kg	1.8 / 2.6 kg
ELECTRICAL DATA		
Voltage / Frequency	12 V DC	24 V DC
Current L35L35	2.8 A	2 A
Starting current	4.3 A	4 A
Max. current	2.9 A	2.2 A
Nominal power L35L35	34 W	50 W
Max. power	35 W	52 W
Fuse rating	5 A (T)	5 A (T)
Connection	Terminal block	
Ingress protection	IP 66 / Type 12, 4, 4X	
Certification	CE, cURus	CE

¹⁾ Depending on the mounting situation the condensation management may need to be considered and possibly adjusted

²⁾ Operating temperature range according to UL -20°C - 65°C

³⁾ Ambient / enclosure

Condensate kit, temperature controller and other accessories on page 98

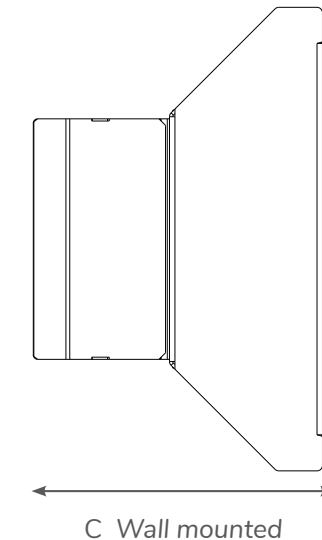
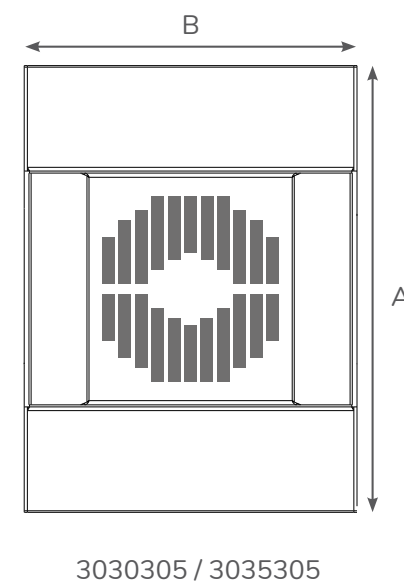
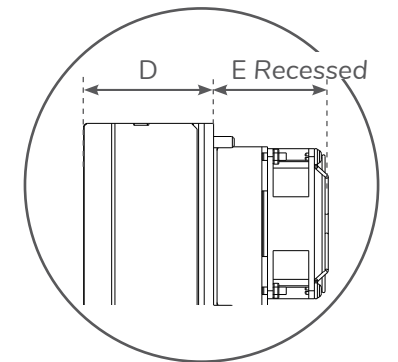
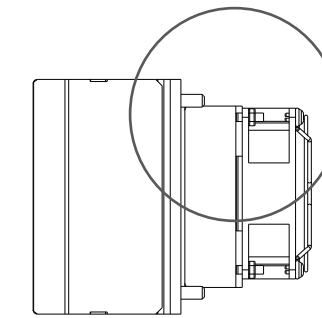
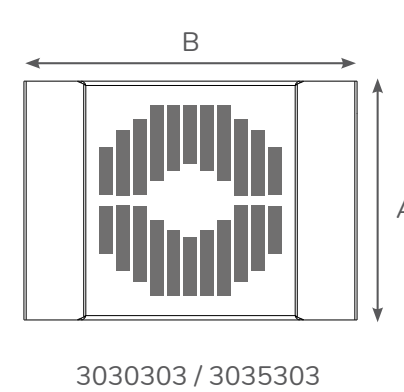
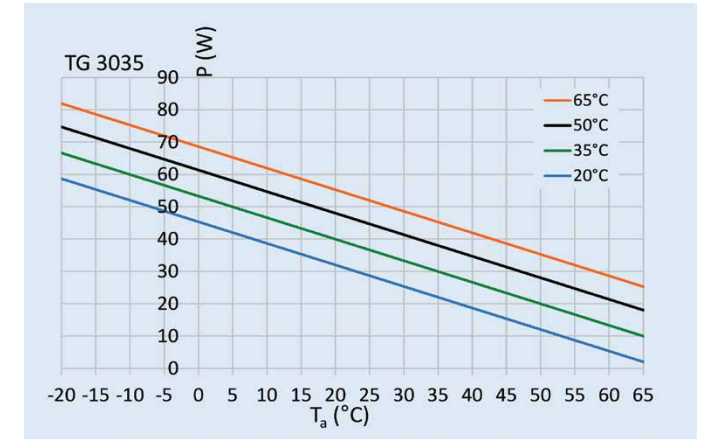
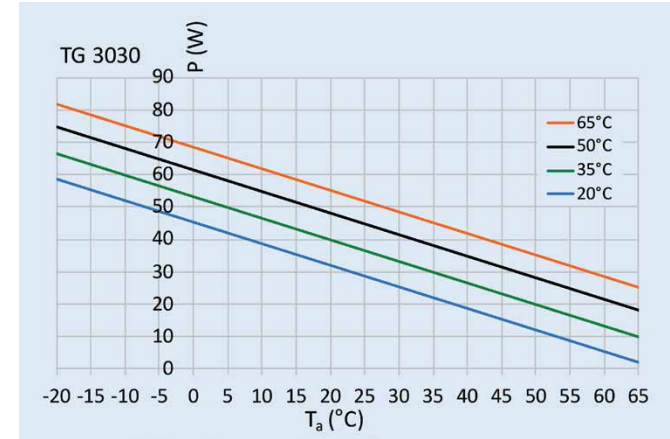



SOLITHERM PELTIER

Thermo electric cooling units for DC voltage

TG 3050 - TG 3075 - TG 3102

- ✓ Cooling capacity: 50 W, 75 W and 100 W
- ✓ For indoor and outdoor applications
- ✓ Can be mounted in any position ¹⁾
- ✓ NEMA / Type 4X rated
- ✓ Ingress protection IP 66
- ✓ Maintenance free

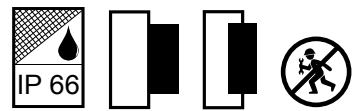

Model	TG 3050	TG 3075	TG 3102
Order no. recess mounting	3050303	3075303	3102303
Order no. wall mounting (with frame)	3050305	3075305	3102305
Order no. in stainless steel 316 (V4A)	305030X4	307530X4	310230X4
Cooling capacity L35L35	50 W	75 W	100 W
Operating temperature range ²⁾	-20°C - 70°C		
System air flow ³⁾	64 / 23 m³/h	116 / 58 m³/h	128 / 46 m³/h
Unimpeded air flow ³⁾	170 / 72 m³/h	306 / 182 m³/h	213 / 90 m³/h
Mounting	Recessed / wall mounted (with frame)		
Dimensions A x B x C (D+E) recessed	206 x 154 x 139 (66+73) mm	250 x 203 x 160 (86+74) mm	200 x 304 x 139 (66+73) mm
Dimensions A x B x C wall mounted	302 x 158 x 136 mm	350 x 217 x 157 mm	302 x 306 x 136 mm
Housing material	Stainless steel 304 (V2A)		
Weight (recessed / wall mounted)	3.3 / 3.9 kg	5.2 kg	5.9 / 7.4 kg
ELECTRICAL DATA			
Voltage / Frequency	24 V DC	24 V DC	24 V DC
Current L35L35	2.4 A	4.6 A	4.8 A
Starting current	3.7 A	6.9 A	7.4 A
Max. current	2.5 A	5.3 A	4.9 A
Nominal power L35L35	58 W	110 W	124 W
Max. power	60 W	127 W	118 W
Fuse rating	4 A (T)	8 A (T)	
Connection	Terminal block		
Ingress protection	IP 66 / Type 12, 4, 4X		
Certification	CE, cURus		

¹⁾ Depending on the mounting situation the condensation management may need to be considered and possibly adjusted

²⁾ Operating temperature range according to UL -20°C - 65°C

³⁾ Ambient / enclosure

Condensate kit, temperature controller and other accessories on page 98

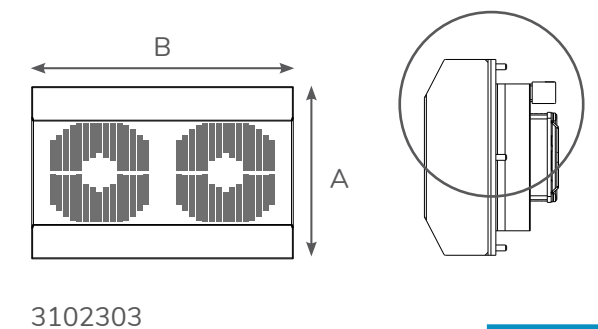
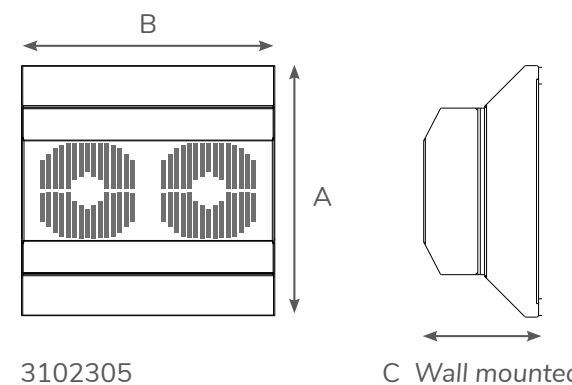
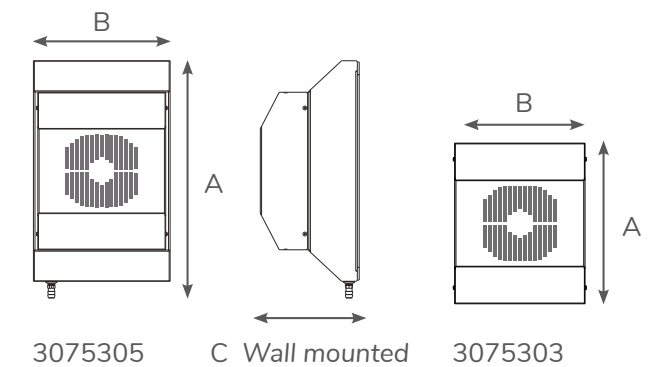
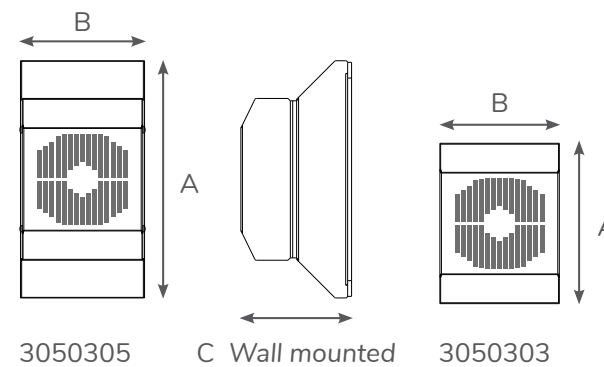
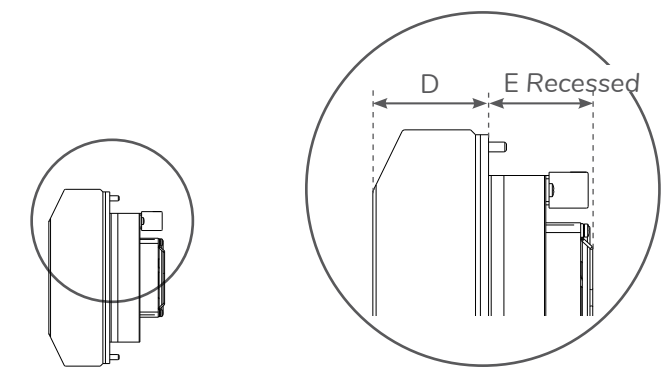
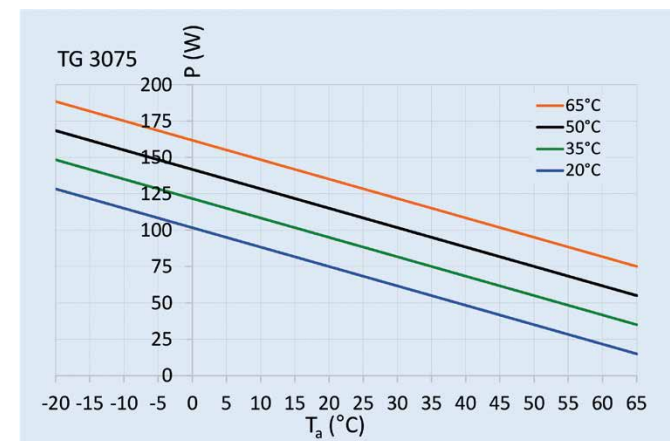
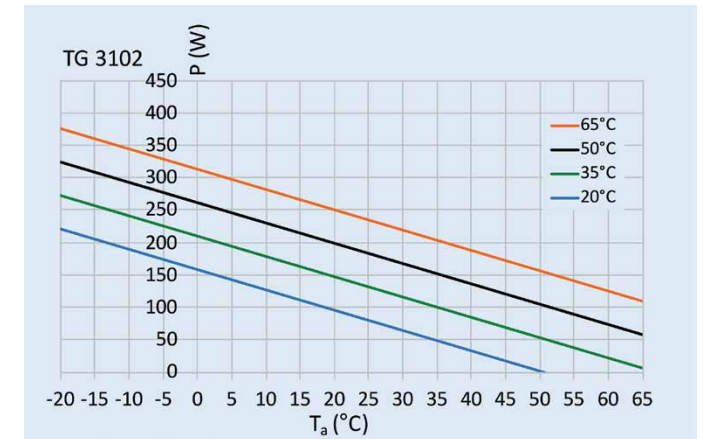
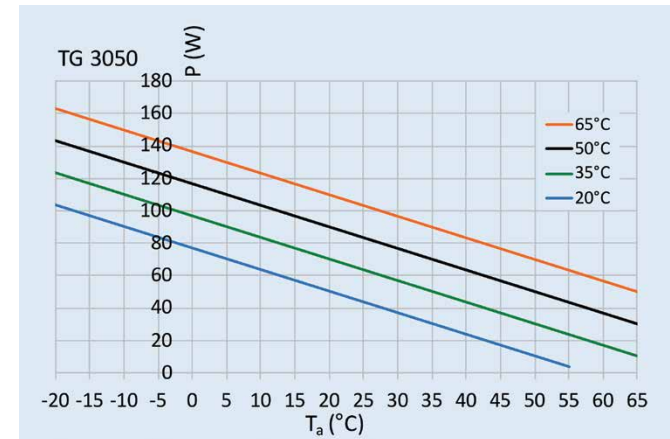



SOLITHERM PELTIER

Thermo electric cooling units for DC voltage

TG 3155 - TG 3152 - TG 3200

- ✓ Cooling capacity: 125 W, 150 W and 200 W
- ✓ For indoor and outdoor applications
- ✓ Can be mounted in any position ¹⁾
- ✓ NEMA / Type 4X rated
- ✓ Ingress protection IP 66
- ✓ Maintenance free

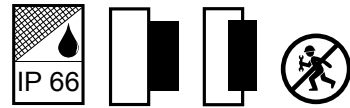

Model	TG 3155	TG 3152	TG 3200	
Order no. recess mounting	3155303	3152303	3200303	3200308
Order no. wall mounting (with frame)	3155305	3152305	3200305	3200310
Order no. in stainless steel 316 (V4A)	315530X4	315230X4	320030X4	32003XX4
Cooling capacity L35L35	125 W	150 W	200 W	
Operating temperature range ²⁾	-20°C - 70°C			
System air flow ³⁾	182 / 58 m ³ /h	120 / 120 m ³ /h		
Unimpeded air flow ³⁾	442 / 168 m ³ /h	260 / 260 m ³ /h		
Mounting	Recessed / wall mounted (with frame)			
Dimensions A x B x C (D+E) recessed	306 x 203 x 160 (86+74) mm	400 x 180 x 170 (76+94) mm		
Dimensions A x B x C wall mounted	406 x 217 x 163 mm	500 x 188 x 168 mm		
Housing material	Stainless steel 304 (V2A)			
Weight (recessed / wall mounted)	6.7 kg	9 / 12.7 kg	10 / 13.7 kg	
ELECTRICAL DATA				
Voltage / Frequency	24 V DC	24 V DC	24 V DC	48 V DC
Current L35L35	9.5 A	6.3 A	9.4 A	4.7 A
Starting current	14.3 A	11 A	17.1 A	9.5 A
Max. current	10.9 A	7.5 A	13.5 A	7.5 A
Nominal power L35L35	228 W	170 W	226 W	226 W
Max. power	262 W	180 W	324 W	360 W
Fuse rating	15 A (T)	10 A (T)	16 A (T)	10 A (T)
Connection	Terminal block			
Ingress protection	IP 66 / Type 12, 4, 4X			
Certification	CE, cURus			

¹⁾ Depending on the mounting situation the condensation management may need to be considered and possibly adjusted

²⁾ Operating temperature range according to UL -20°C - 65°C

³⁾ Ambient / enclosure

Condensate kit, temperature controller and other accessories on page 98

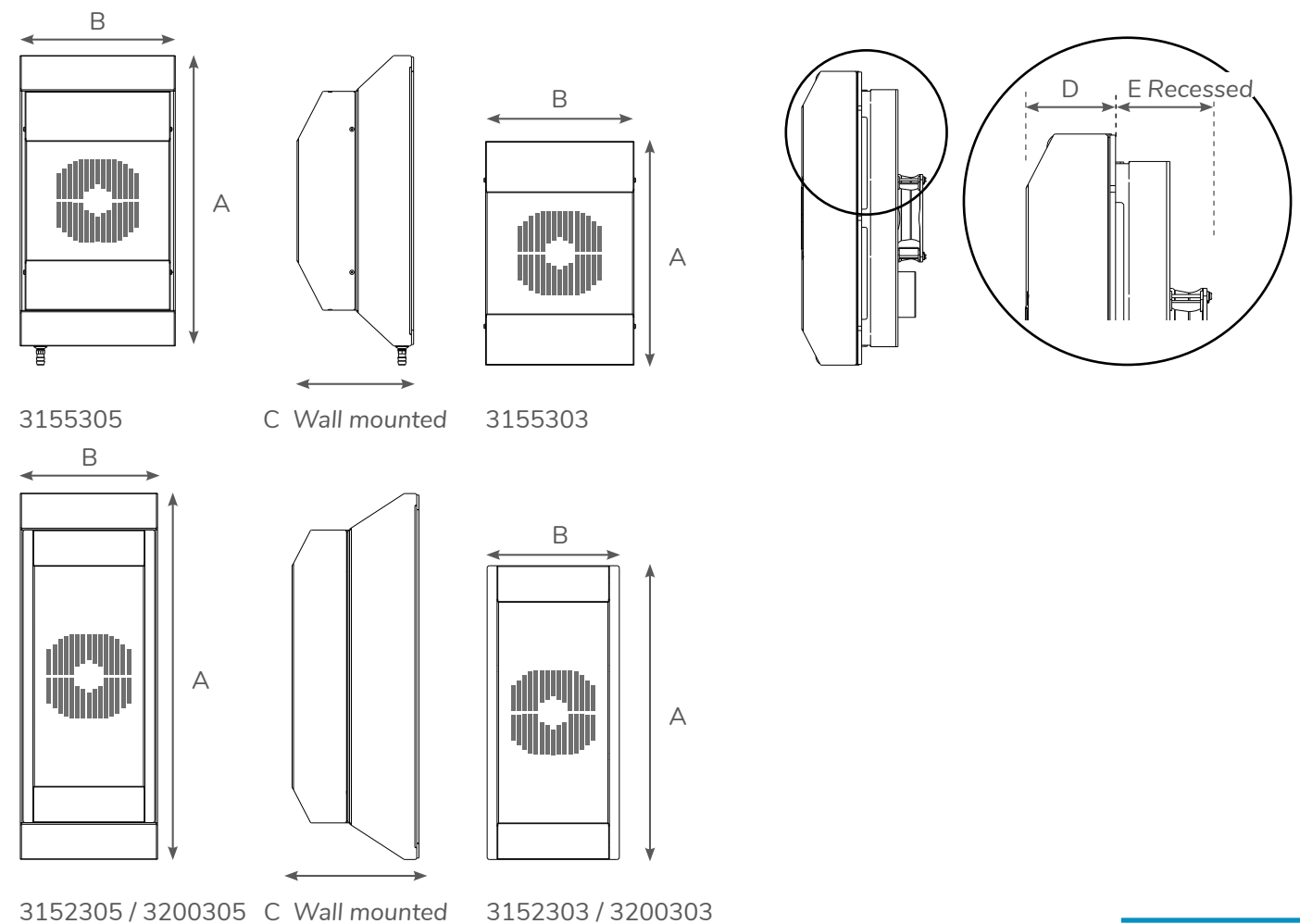
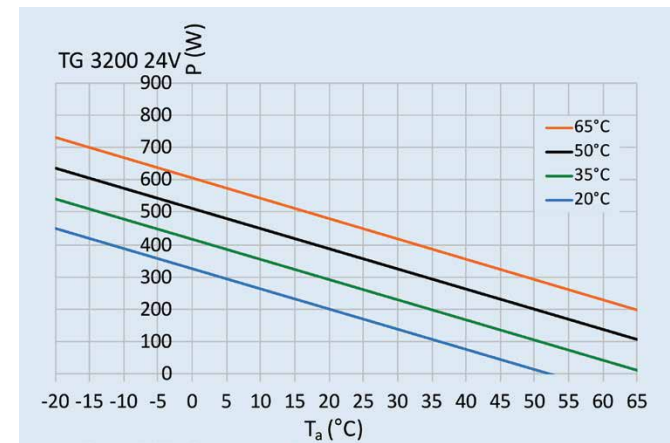
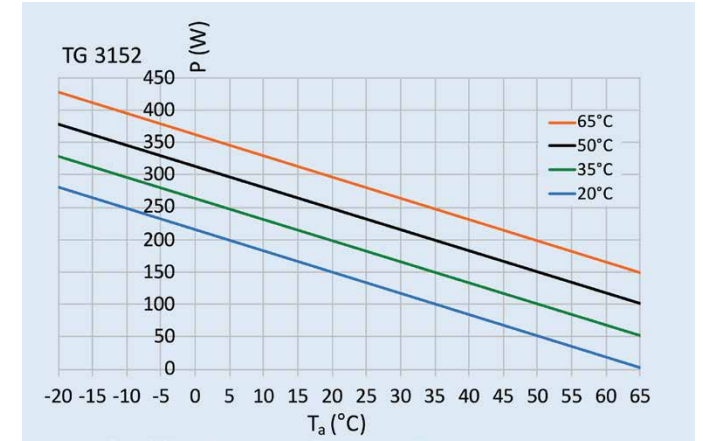
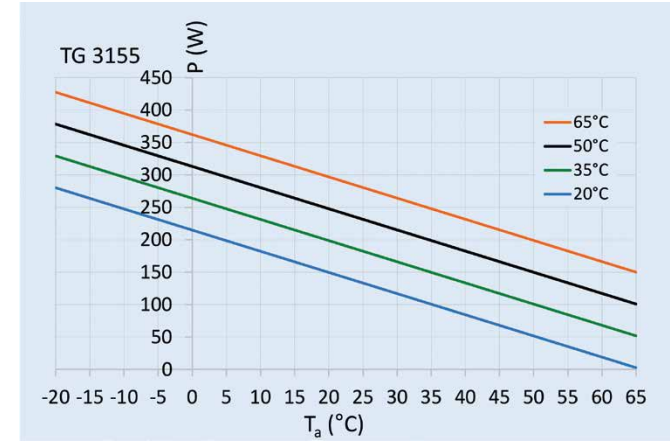



SOLITHERM PELTIER

Thermo electric cooling units for AC voltage

TG 6105 - TG 6155 - TG 6205

- ✓ Cooling capacity: 100 W, 150 W and 200 W
- ✓ For indoor and outdoor applications
- ✓ Can be mounted in any position¹⁾
- ✓ NEMA / Type 4X rated
- ✓ Ingress protection IP 66
- ✓ Maintenance free



Model	TG 6105		TG 6155		TG 6205	
Order no. recess mounting	6105323	6105313	6155323	6155313	6205323	6205313
Order no. wall mounting (with frame)	6105325	6105315	6155325	6155315	6205323	6205313
Order no. in stainless steel 316 (V4A)	61053XX4		61553XX4		62053XX4	
Cooling capacity L35L35	100 W		150 W		200 W	
Operating temperature range	-20°C - 70°C					
Setting range	20°C - 50°C (cooling)					
System air flow ²⁾	128 / 46 m ³ /h		120 / 60 m ³ /h		106 / 150 m ³ /h	
Unimpeded air flow ²⁾	213 / 90 m ³ /h		260 / 170 m ³ /h		260 / 260 m ³ /h	
Mounting	Recessed / wall mounted (with frame)					
Dimensions A x B x C (D+E) recessed	281 x 353 x 175 (107+68) mm			500 x 333 x 181 (113+68) mm		
Dimensions A x B x C wall mounted	281 x 353 x 157 mm			500 x 333 x 187 mm		
Housing material	Stainless steel 304 (V2A)					
Weight (recessed / wall mounted)	9.4 / 11 kg		18 / 19 kg		17.2 / 21 kg	
ELECTRICAL DATA						
Voltage / Frequency	230 V ~ 50/60 Hz		120 V ~ 60 Hz		230 V ~ 50/60 Hz	
Current L35L35	0.5 A		1.0 A		2.1 A	
Starting current	0.8 A		1.6 A		3.2 A	
Max. current	0.6 A		1.2 A		2.2 A	
Nominal power L35L35	125 W		170 W		250 W	
Max. power	139 W		180 W		270 W	
Fuse rating	1 A (T)		2 A (T)		4 A (T)	
Connection	Terminal block					
Ingress protection	IP 66 / Type 12, 4, 4X					
Certification	CE, cURus					

¹⁾ Depending on the mounting situation the condensation management may need to be considered and possibly adjusted

²⁾ Ambient / enclosure

Condensate kit, temperature controller and other accessories on page 98

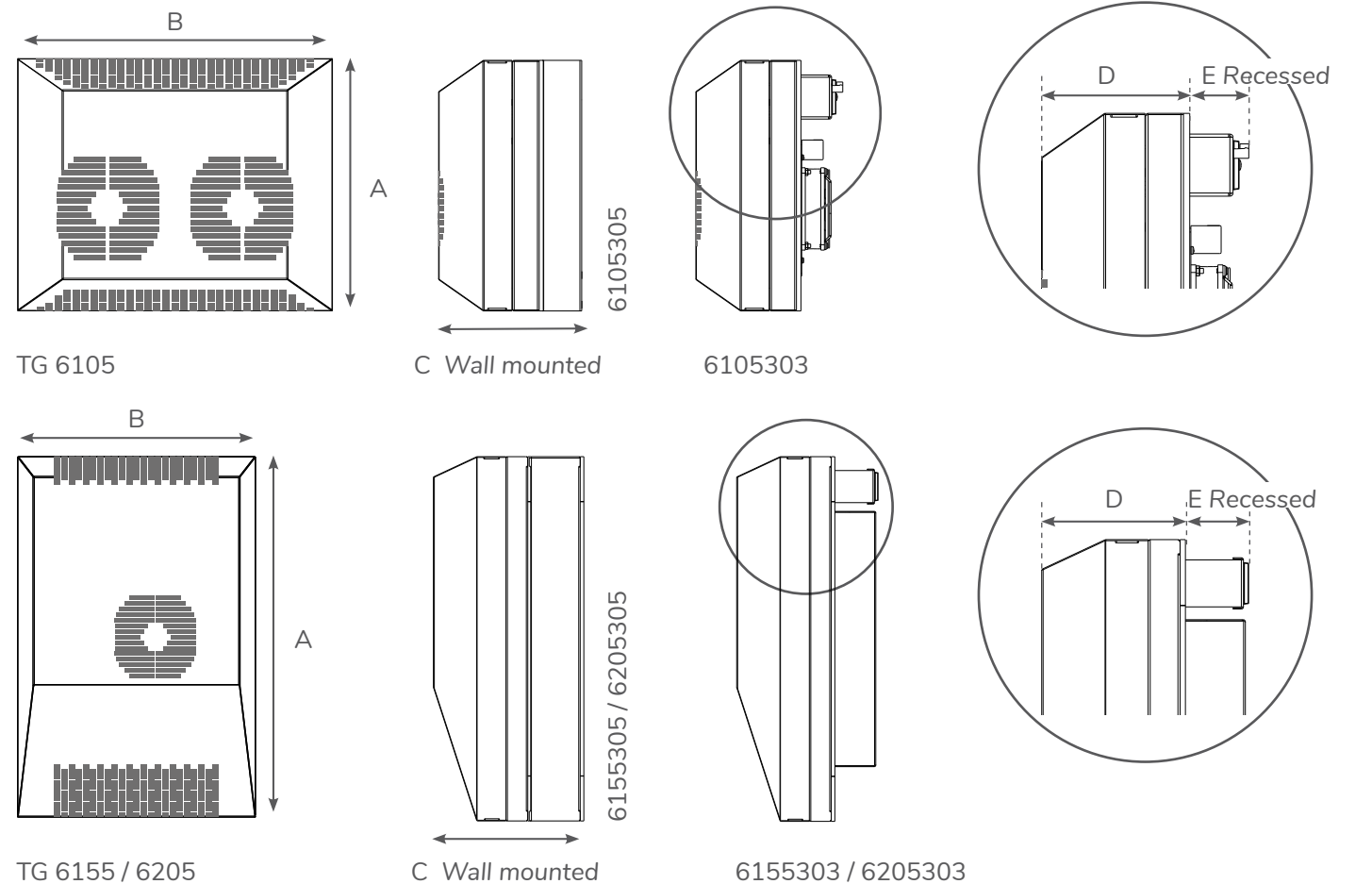
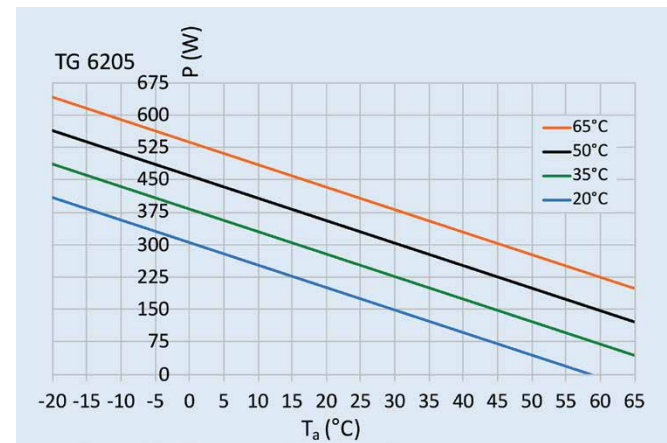
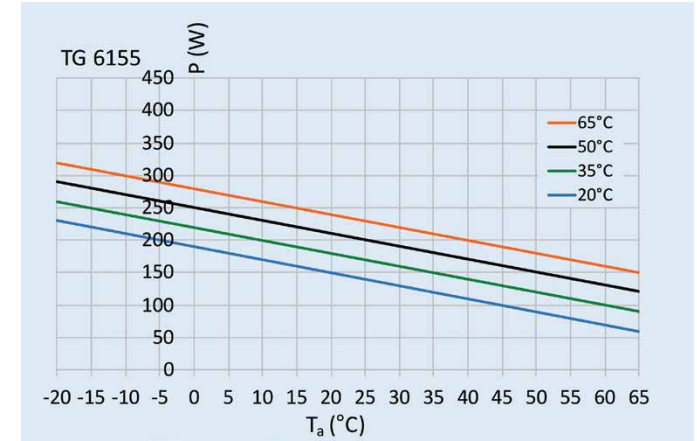
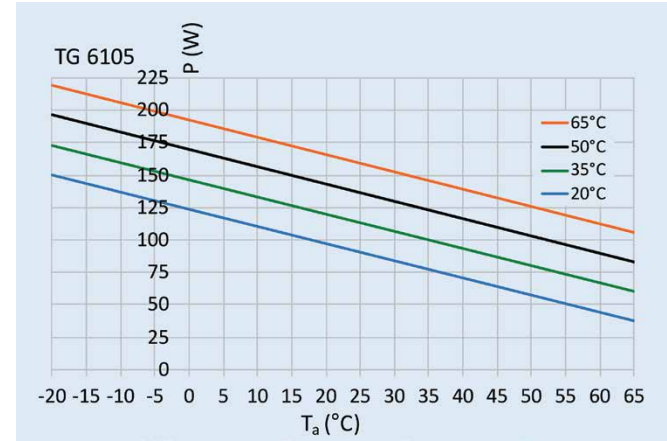



SOLITHERM PELTIER

Thermo electric cooling units for AC voltage

TG 6405 - TG 6805

- ✓ Cooling capacity: 400 W and 800 W
- ✓ For indoor and outdoor applications
- ✓ Can be mounted in any position ¹⁾
- ✓ NEMA / Type 4X rated
- ✓ Ingress protection IP 66
- ✓ Maintenance free



Model	TG 6405		TG 6805	
Order no. recess mounting	6405323	6405313	6805323	6805313
Order no. wall mounting (with frame)	6405325	6405315	6805325	6805315
Order no. in stainless steel 316 (V4A)	64053XX4		68053XX4	
Cooling capacity L35L35	400 W		800 W	
Operating temperature range	-20°C - 70°C			
Setting range	20°C - 50°C (cooling)			
System air flow ²⁾	240 / 240 m ³ /h		480 / 480 m ³ /h	
Unimpeded air flow ²⁾	325 / 325 m ³ /h		650 / 650 m ³ /h	
Mounting	Recessed / wall mounted (with frame)			
Dimensions A x B x C (D+E) recessed	600 x 433 x 199 (133+66) mm		975 x 517 x 202 (134+68) mm	
Dimensions A x B x C wall mounted	600 x 433 x 203 mm		975 x 517 x 205 mm	
Housing material	Stainless steel 304 (V2A)			
Weight (recessed / wall mounted)	34 / 37 kg		66 / 70 kg	
ELECTRICAL DATA				
Voltage / Frequency	230 V ~ 50/60 Hz	120 V ~ 60 Hz	230 V ~ 50/60 Hz	120 V ~ 60 Hz
Current L35L35	2.1 A	4.1 A	4.3 A	8.2 A
Starting current	3.4 A	6.5 A	8 A	14 A
Max. current	2.3 A	4.5 A	4.7 A	9.0 A
Nominal power L35L35	490 W		980 W	
Max. power	537 W		1078 W	
Fuse rating	4 A (T)	7 A (T)	7 A (T)	13 A (T)
Connection	8 - pole connector			
Ingress protection	IP 66 / Type 12, 4, 4X			
Certification	CE, cURus			

¹⁾ Depending on the mounting situation the condensation management may need to be considered and possibly adjusted

²⁾ Ambient / enclosure

Condensate kit, temperature controller and other accessories on page 98

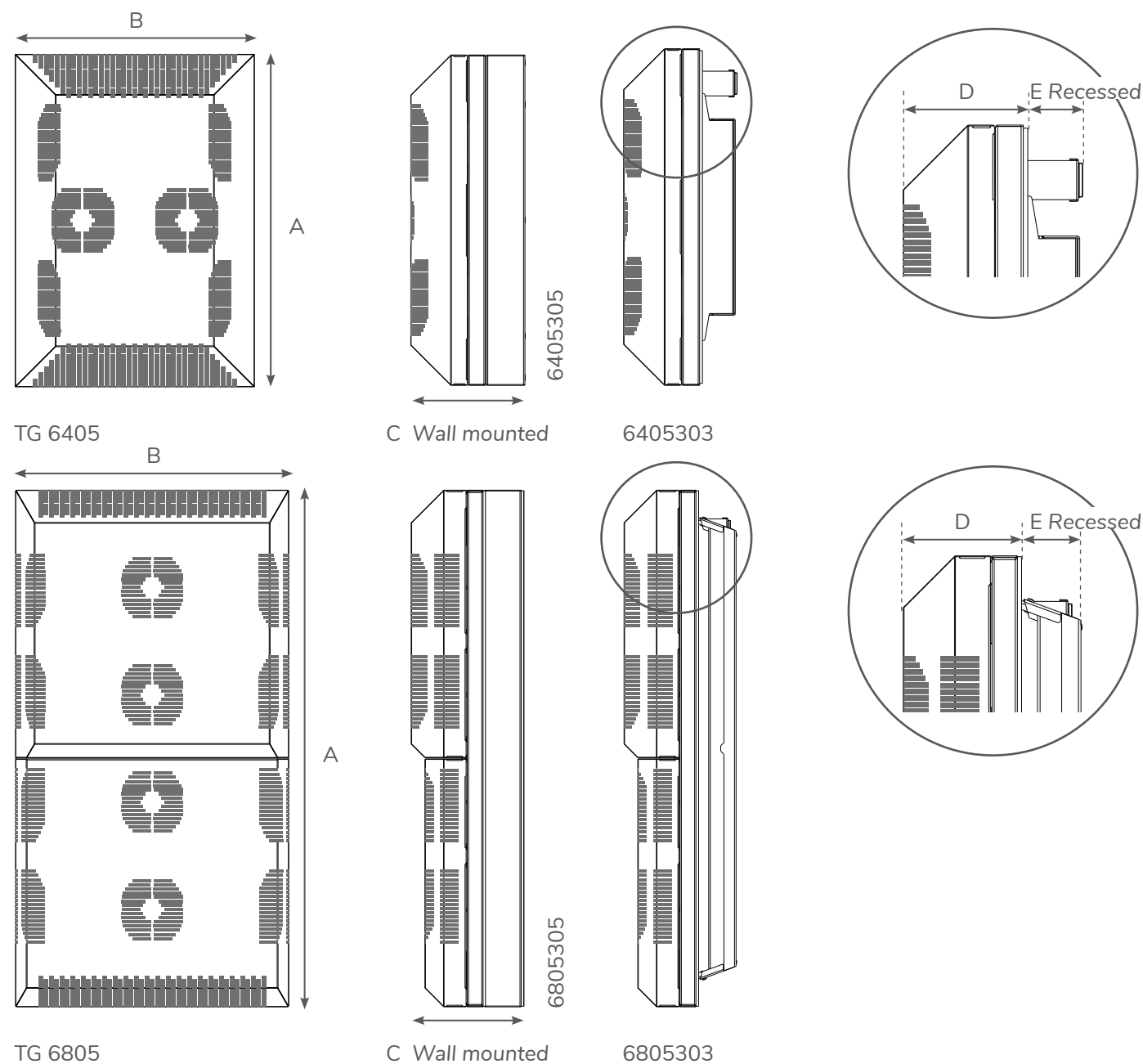
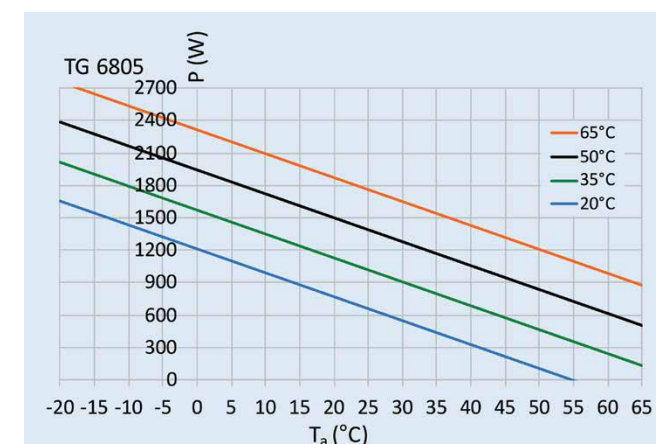
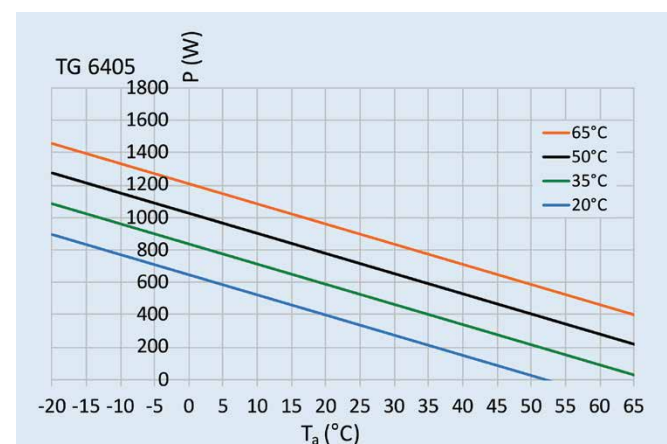



SOLITHERM PELTIER

Thermo electric cooling unit explosion protected

TG 31529556 EX

- ✓ Cooling capacity: 150 W
- ✓ For indoor and outdoor applications
- ✓ Can be mounted in any position ¹⁾
- ✓ Ingress protection IP 66
- ✓ Maintenance free
- ✓ ATEX classification II -/3 D Ex tc IIIC T90 °C -/Dc



Model	TG 31529556 EX
Order number	31529556
Cooling capacity L35L35	150 W
Operating temperature range	-20°C - 55°C
System air flow ²⁾	140 / 90 m³/h
Unimpeded air flow ²⁾	260 / 170 m³/h
Mounting	recessed
Dimensions A x B x C (D+E)	405 x 185 x 165 (82+83) mm
Housing material	Stainless steel 304 (V2A)
Weight	9 kg
ELECTRICAL DATA	
Voltage / Frequency	24 V DC
Current L35L35	7 A
Starting current	11 A
Max. current	7.5 A
Nominal power L35L35	170 W
Max. power	180 W
Fuse rating	13 A (T)
Connection	Connector
Ingress protection	IP 66
Certification	CE, ATEX (zones 2,22)

¹⁾ Depending on the mounting situation the condensation management may need to be considered and possibly adjusted

²⁾ Ambient / enclosure

Condensate kit, temperature controller and other accessories on page 98

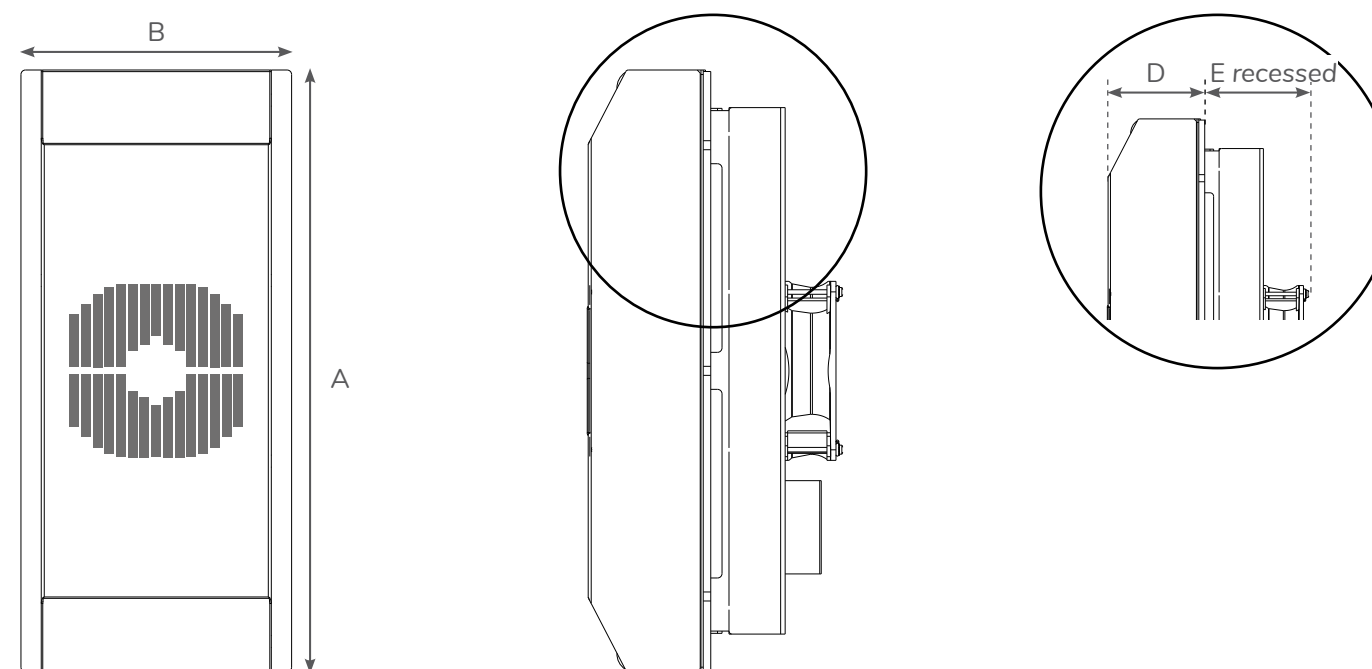
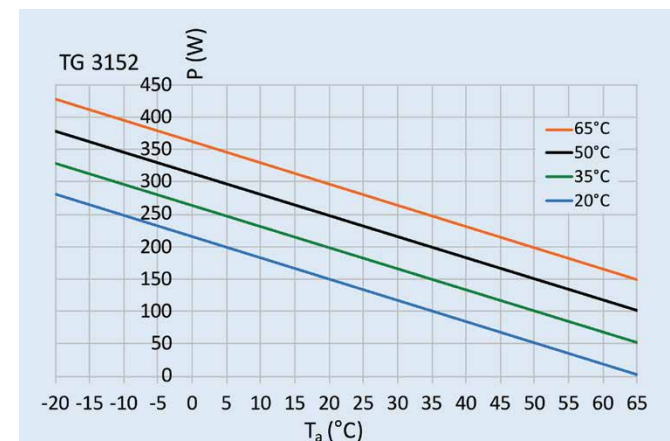

31529556 EX



SOLITHERM PELTIER

Thermoelectric dehumidifier

TG 3039

- ✓ For indoor and outdoor applications
- ✓ Condensate pump optional
- ✓ Ingress protection IP 56
- ✓ Maintenance free
- ✓ Flexible mounting options

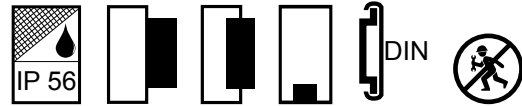

Model	TG 3039	
Order number	3039303	3039309
With condensate pump	No	Yes
Condensation rate (30°C / 80% rF)	23 ml / hr.	
Operating temperature range	0°C - 65°C	
Operating humidity range	0% - 90% rF	
Mounting	Recessed / DIN rail / enclosure floor / Wall mounted ¹⁾	Recessed / DIN rail / enclosure floor
Dimensions A x B x C (D+E)	136 x 176 x 133 (72+61) mm / ¹⁾ 179 x 179 x 133 mm	136 x 176 x 133 (72+61) mm
Housing material / colour	Plastic / RAL 9011	
Weight	1.8 kg	2.3 kg
ELECTRICAL DATA		
Voltage / Frequency	24 V DC	
Power consumption L35L35	50 W	
Connection	2 - pole connector	
Ingress protection	IP 56 / Type 3S	
Protection (condensate management)	IP 66 / Type 4 / 4X	
Certification	CE, cURus	

¹⁾ With mounting frame order no. 1019305

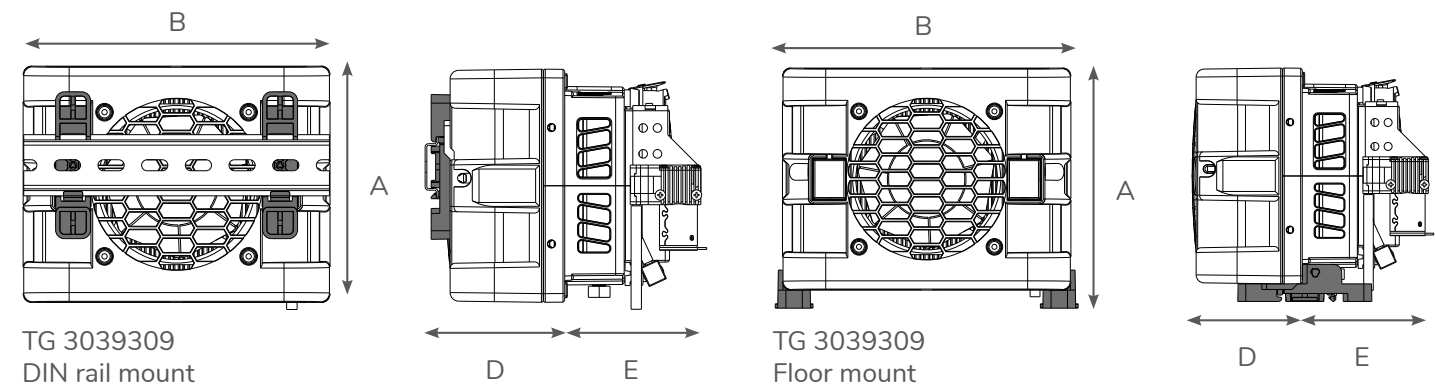
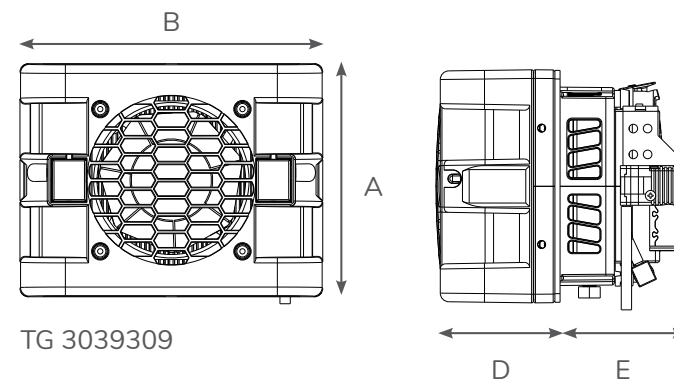
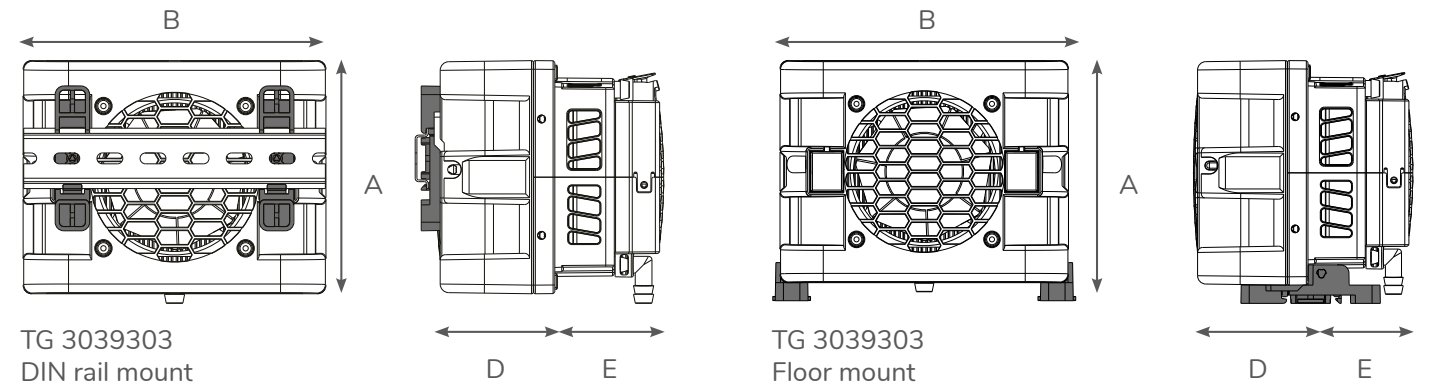
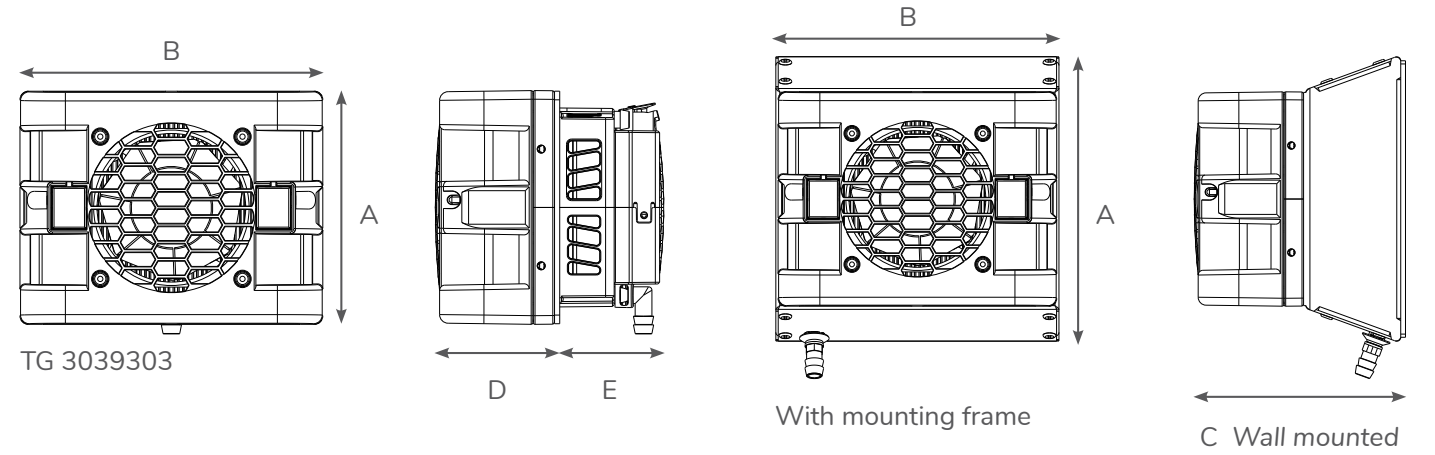

SOLITHERM PELTIER accessories

Order number	Description
1001303	Condensate kit for Peltier TG 3050 / 3050
1002303	Condensate kit for Peltier TG 3152 / 3200
1003303	Condensate kit for Peltier TG 3102 / 6155 / 6205
1004303	Condensate kit for Peltier TG 6105
1005303	Condensate kit for Peltier TG 6405
1006303	Condensate kit for Peltier TG 6805
1008303	Condensate kit for Peltier TG 3075 / 3155

Order number	Description
7800000	Bi-metal controller for heating / cooling of Peltier units with DC voltage. 24 V DC max. 20 A, cooling: 0 - 60°C heating: -10 - 59°C

Order number	Description
3100001	Door contact switch with mounting bracket, 2 x M4 screws

Compatible with the door contact interface of the cooling unit. Prevents the formation of condensation when the enclosure door is open.

Order number	Description
301510	Electronic change-over thermostat, 24 V DC / 16 A Setting range: 0 - 60°C, Hyst. 3K / Sw. Pt. tol 3K
301512	Electronic change-over thermostat, 24 V DC / 16 A Setting range: 0 - 60°C, Hyst. 1K / Sw. Pt. tol 3K

Order number	Description
1011305	Mounting frame for Peltier TG 3030 / 3035
1012305	Mounting frame for Peltier TG 3050
1019305	Mounting frame for Peltier TG 3075
1013305	Mounting frame for Peltier TG 3102
1020305	Mounting frame for Peltier TG 3155
1014305	Mounting frame for Peltier TG 3152 / 3200
1015305	Mounting frame for Peltier TG 6105
1016305	Mounting frame for Peltier TG 6155 / 6205
1017305	Mounting frame for Peltier TG 6405
1018305	Mounting frame for Peltier TG 6805
1019305	Mounting frame for dehumidifier TG 3905

Cannot be used for EX protected units

Order number	Description
AC-TG-6XXX-M-01	Water drain socket IP 66



ENCLOSURE COOLING FOR 19" RACKS

SOLITHERM 19" RACK

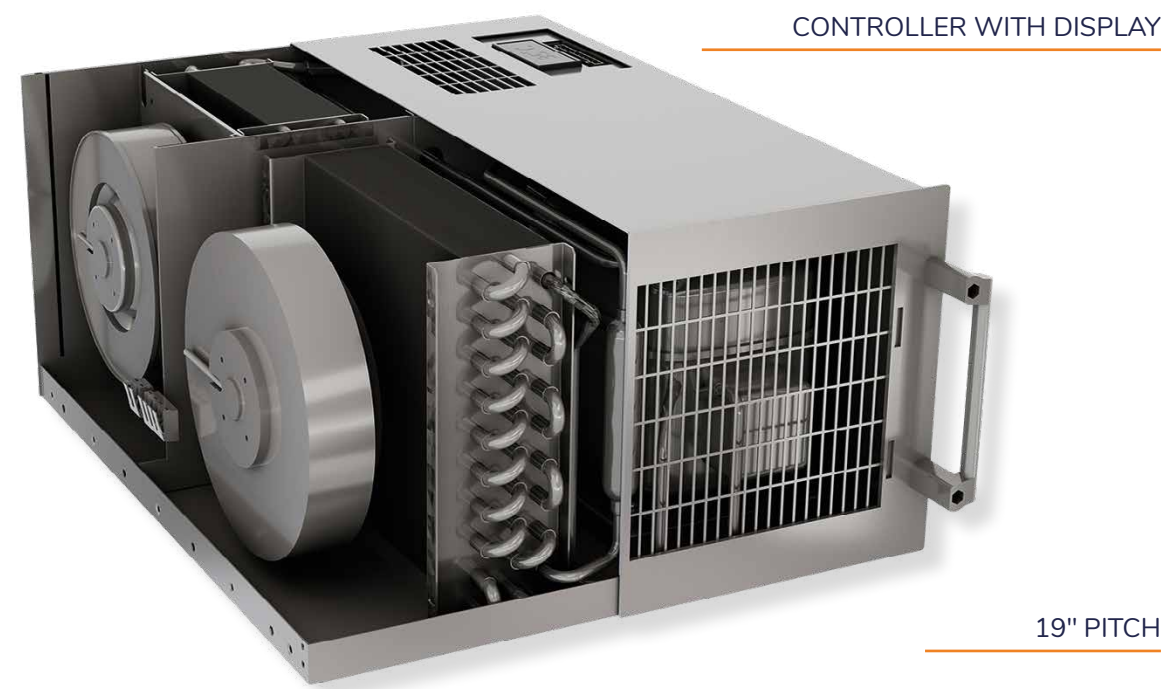

Fig. Compressor cooling unit 19"

COOLING UNITS FOR 19" RACK INDUSTRIAL ENCLOSURES

SOLITHERM 19" RACK are compressor cooling units and air / water heat exchanger in 19" pitch size.

They guarantee efficient heat dissipation to protect the existing electronics and are ideally suited for use in data centers and server rooms.

With a cooling capacity (L35W10) of 1 kW and a unit height of only 2U, our heat exchangers reach top values in terms of performance versus dimensions.

The drip-free quick-release couplings on the hose pipes enable uncomplicated and safe installation and maintenance, even when the water pressure is present.



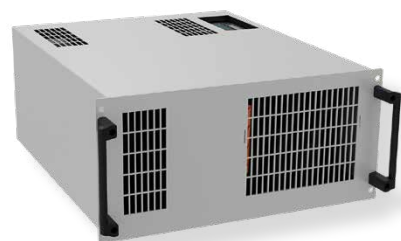

SOLITHERM 19" RACK

Compressor cooling units

KG 4533 - KG 4534 - KG 4535

- ✓ Cooling capacities: 550 W, 850 W and 900 W
- ✓ For use in 19" industrial enclosures
- ✓ Maintenance free
- ✓ Condensate kit included



Model	KG 4533	KG 4534	KG 4535	
Order number	45330001	45340001	4535000	4535100
Cooling capacity L35L35 ¹⁾	550 / 570 W	850 / 930 W	900 / 950 W	950 / 950 W
Cooling capacity L35L50 ¹⁾	370 / 445 W	590 / 635 W	700 / 750 W	750 / 750 W
Compressor type	Reciprocating		Rotary piston	
Operating temperature range	20°C - 55°C		10°C - 55°C	
Setting range	20°C - 55°C			
System air flow ²⁾	177 / 265 m ³ /h	250 / 280 m ³ /h	450 / 210 m ³ /h	
Unimpeded air flow ²⁾	550 / 450 m ³ /h	850 / 550 m ³ /h	1200 / 650 m ³ /h	
Mounting	19" rack			
Dimensions A x B x C	5U (222) x 483 x 549 mm	6U (266) x 483 x 549 mm		
Housing material / colour	Mild steel powder coated / RAL 7035			
Weight	28 kg	33 kg	45 kg	
ELECTRICAL DATA				
Voltage / Frequency	230 V ~ 50/60 Hz	230 V ~ 50/60 Hz	230 V ~ 50/60 Hz	120 V ~ 60 Hz
Current L35L35 ¹⁾	2.1 A	4.5 / 4.3 A	3.0 / 3.2 A	9 A
Starting current	9.1 A	19.7 A	7 A	33 A
Max. current	2.5 A	5.8 A	3.5 A	
Nominal power L35L35 ¹⁾	374 / 425 W	795 / 900 W	700 / 750 W	1.15 kW
Max. power	525 W	1.22 kW	805 W	
Fuse rating	6 A (T)		10 A (T)	
Connection	Terminal block		Connection cable 3 m	
IP Ingress protection	IP 54		IP 44	
Certification	CE		CE, cURus	

¹⁾ Values for 50/60 Hz

²⁾ Ambient / enclosure

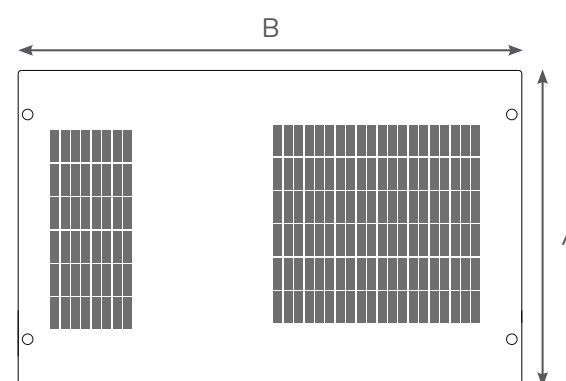
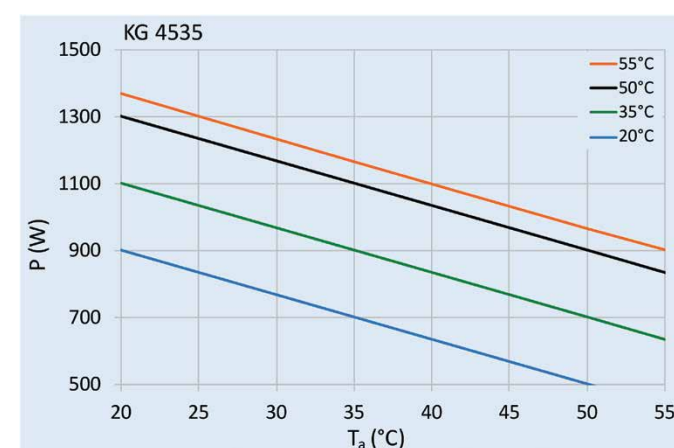
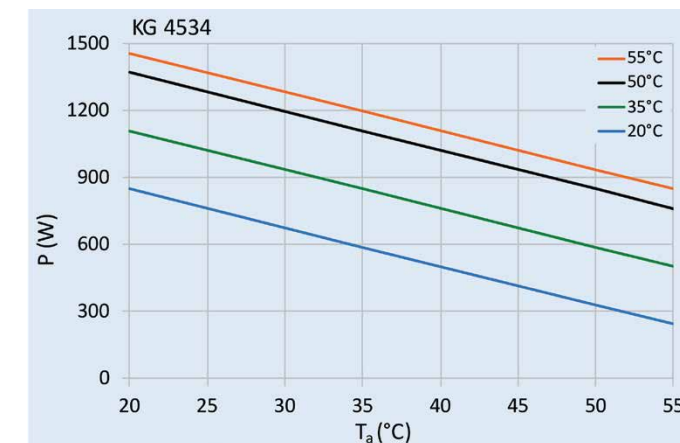
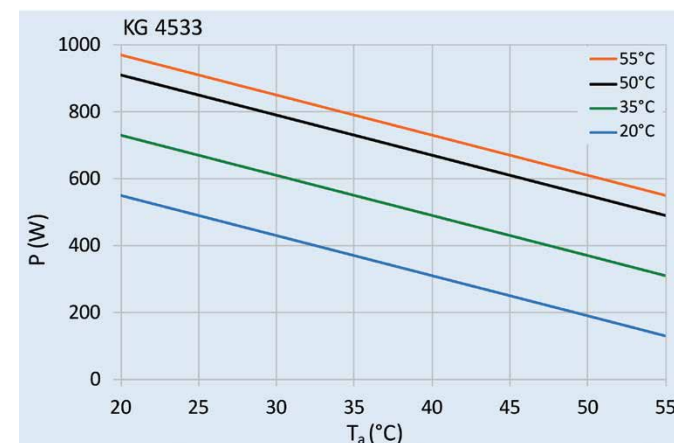

KG 4533 / 34

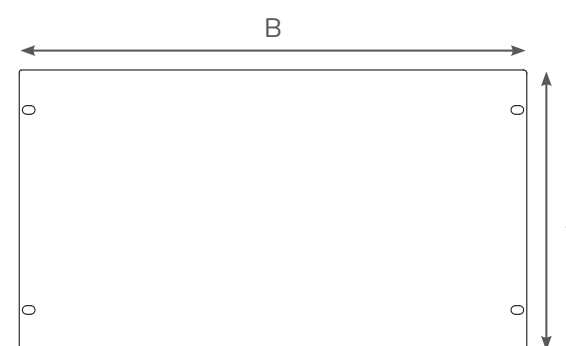

KG 4535

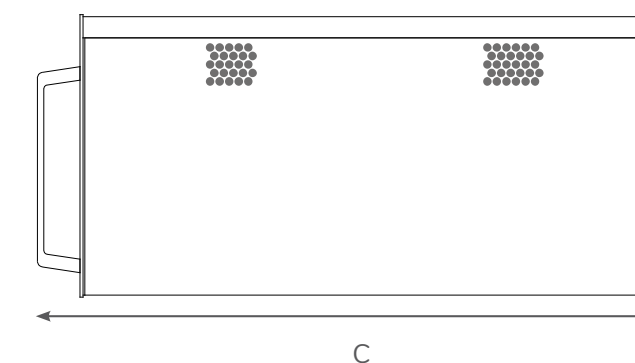
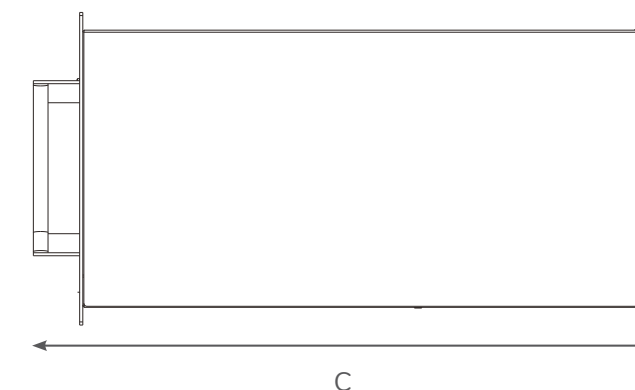

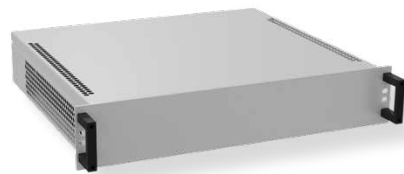

SOLITHERM 19" RACK

Air / water heat exchanger

RK 2192 - RK 2194 - RK 2197

- ✓ Cooling capacities: 1 kW, 2 kW, 2.1 kW and 2.45 kW
- ✓ For use in 19" industrial enclosures
- ✓ Maintenance free
- ✓ Condensate kit included

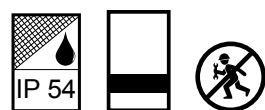

Model	RK 2192		RK 2194		RK 2197	
Order no. with magnetic valve	2192000	2192100	-	-	-	-
Order no. with prop. water flow regulator	-	-	2194000	2194100	2197001	2197100
Cooling capacity L35W10 (200 l/h)	1.0 kW		2.0 kW		2.1 kW	2.45 kW
Cooling capacity L35W10 (500 l/h)	1.2 kW		2.35 kW		2.4 kW	2.80 kW
Coolant	Water, light oils or similar					
Operating temperature range	1°C - 72°C					
Max. air flow volume ¹⁾	165 / 180 m³/h	180 m³/h	360 / 370 m³/h	370 / 410 m³/h	300 / 340 m³/h	340 m³/h
Mounting	19" rack					
Dimensions A x B x C	89 (2U) x 443 x 408 mm		178 (4U) x 443 x 505 mm		178 (4U) x 443 x 544 mm	
Housing material / colour	Mild steel powder coated / RAL 7035					
Weight	13 kg		16.5 kg		16.9 kg	
Max. working pressure water circuit	10 bar					
Water connection	1/4" internal thread with 2 connection pieces for pipe inner Ø of 10 mm, hose 510 mm with quick-release coupling				1/4" internal thread with 2 connection pieces for internal pipe Ø of 10 mm	
ELECTRICAL DATA						
Voltage / Frequency	230 V ~ 50/60 Hz	120 V ~ 50/60 Hz	230 V ~ 50/60 Hz	90 - 265V ~ 50/60 Hz	230 V ~ 50/60 Hz	120 V ~ 60Hz
Max. current	0.4 A	0.8 A	0.45 A	0.6 A	0.6 A	1.2 A
Starting current	1 A	2 A	2.5 A	2.5 A	2 A	4 A
Max. power	90 W		100 W	150 W	75 W	
Fuse rating	4 A (T)					
Connection	IEC connector					
IP Ingress protection	IP 54					
Certification	CE					

¹⁾ Ambient / enclosure

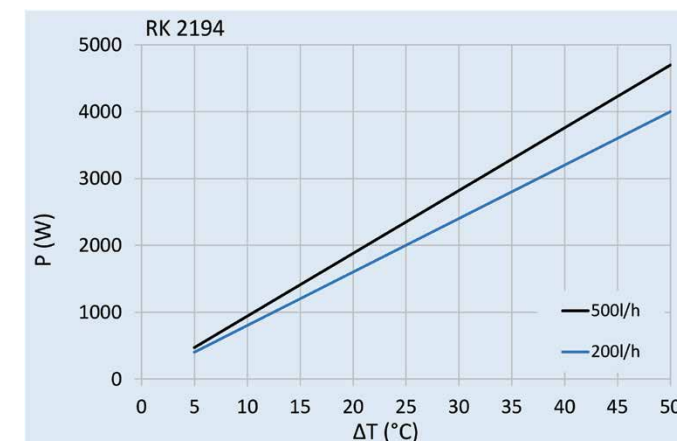
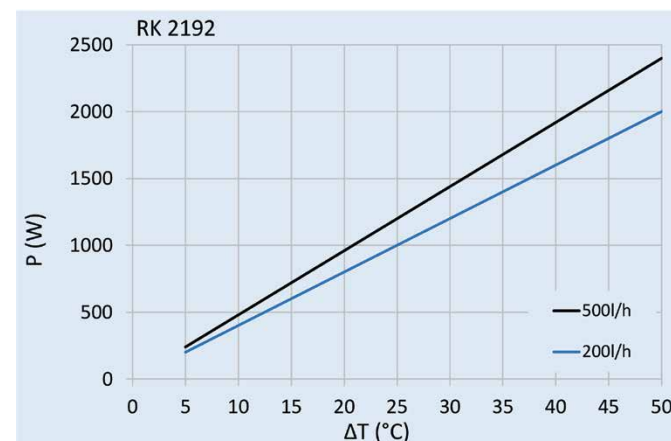

ΔT = Temperature difference between enclosure air and coolant

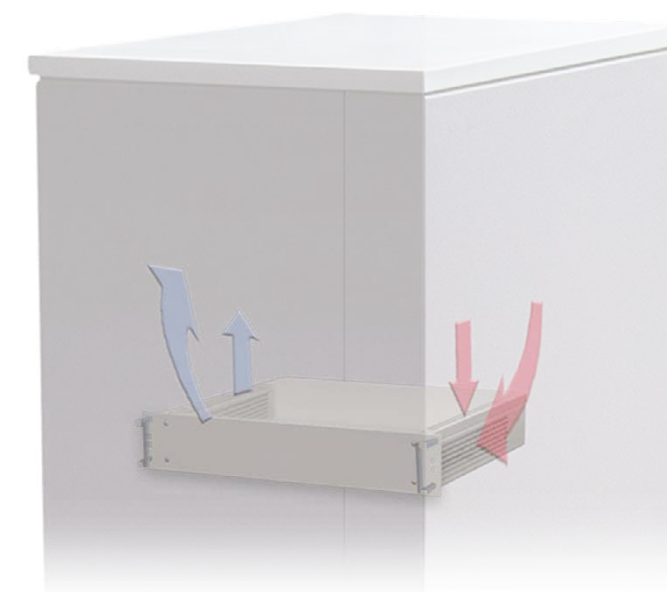
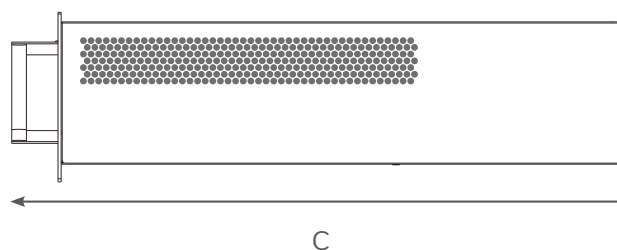
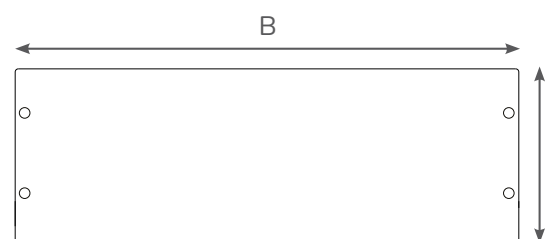

HEAT EXCHANGER CUTOUT COMPATIBLE WITH COOLING UNITS

SLIMLINE HEX air / water heat exchanger series 7500

SAME CUTOUT AS
SLIMLINE PRO COOLING UNITS

DIFFERENT COLD AIR OUTLET
OPENINGS (FROM 700 W)

PROTECTION CLASS IP 55
IN STAINLESS STEEL NEMA / TYPE 4X



WATER CONNECTION
OPTIONAL AT THE TOP

CONTROLLER WITH
DISPLAY AND MAGNETIC
VALVE OPTIONAL

WATER CONNECTION
AT THE BOTTOM

AIR / WATER HEAT EXCHANGERS FOR THE INDUSTRY

SLIMLINE HEX air / water heat exchangers dissipate heat safely and reliably from industrial enclosures, provided a cold water connection is available.

The heat exchangers of the 7500 series are cutout compatible with our enclosure cooling units SLIMLINE PRO and VARIO (pages 22, 32).

For applications where hygiene or high corrosion protection is important, we also offer our heat exchangers with stainless steel water pipes.

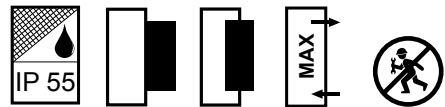



SLIMLINE HEX

Air / water heat exchanger

RK 7506

- ✓ Cooling capacity: 700 W
- ✓ An optimal way of cooling when a cold water supply is readily available
- ✓ Maintenance free
- ✓ Wall or recess mounting
- ✓ Cutout compatible with SLIMLINE PRO cooling units KG 8506 (page 22)

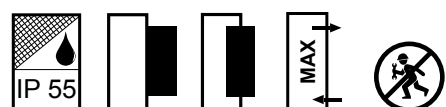

Model	RK 7506			
Order number	750640B001		750620B001	
Order no. with controller & magnetic valve		750641B001		750621B001
Order no. in stainless steel 304 (V2A)	7506XXB62			
Cooling capacity A35A10 (200 l/h)	700 W			
Coolant	Water, light oils or similar			
Operating temperature range	1°C - 60°C			
Air flow volume (system / unimpeded) ¹⁾	110 / 220 m ³ /h			
Mounting	Wall mounted / recessed			
Dimensions A x B x C (D+E)	600 x 250 x 127 (37+90) mm			
Housing material / colour	Mild steel powder coated, RAL 7035			
Weight	7.5 kg	8.5 kg	7.5 kg	8.5 kg
Max. working pressure water circuit	10 bar			
Water connection	Rp 3/8" internal thread (with optional connections for internal pipe Ø of 10 mm)			
ELECTRICAL DATA				
Voltage / Frequency	120 - 230 V ~ 50/60 Hz	230 V ~ 50/60 Hz	380/415 V 50 Hz 2~ 400/460 V 60 Hz 2~	380/415 V 50 Hz 2~ 400/460 V 60 Hz 2~
Max. current ²⁾	0,25 / 0,35 A	0,35 A	0,2 A	0,25 A
Starting current ²⁾	1,0 / 1,4 A	1,4 A	0,8 A	1,0 A
Max. power	15 W	30 W	20 W	35 W
Fuse rating	1 A (T)			
Connection	4 - pole connector for power, 5 - pole connector for signals			
Ingress protection	IP 55 / Type 12 (with gasket kit expandable to Type 3, 3R, 4 and 4X for stainless steel models)			
Certification	CE, cURus, cULus			

¹⁾ Enclosure

²⁾ Values for 50/60 Hz

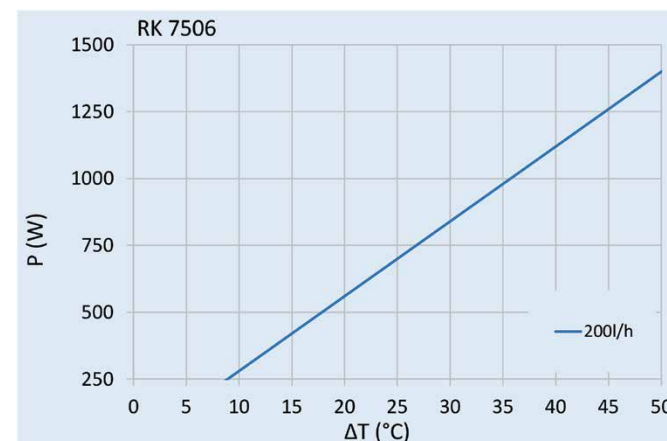

ΔT = Temperature difference between enclosure air and coolant

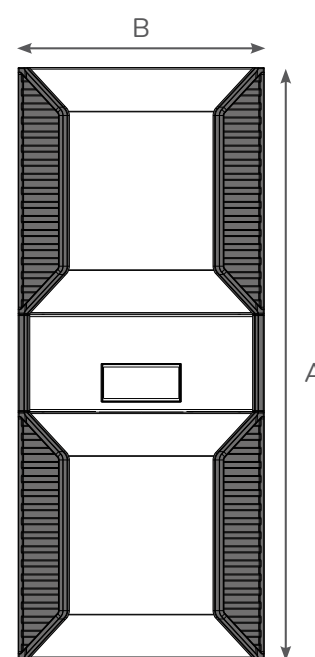

RK 7506

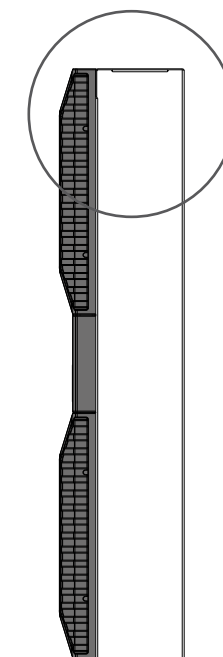

C Wall mounted

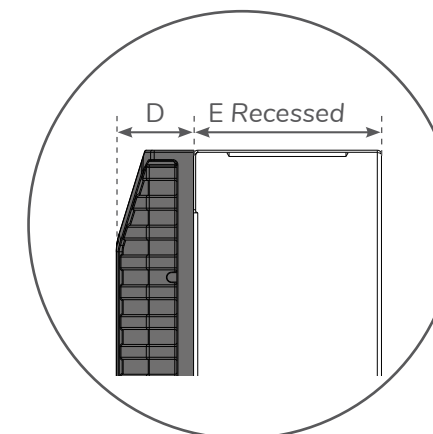



SLIMLINE HEX

Air / water heat exchanger

RK 7306

- ✓ Cooling capacity: 700 W
- ✓ An optimal way of cooling when a cold water supply is readily available
- ✓ Maintenance free
- ✓ Wall mounting
- ✓ Cutout compatible with SLIMLINE PRO cooling units KG 8505 (page 22)

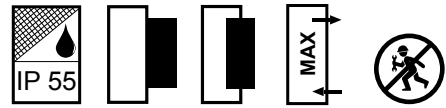

Model	RK 7306			
Order number	730640B001		730620B001	
Order no. with controller & magnetic valve		730641B001		730621B001
Order no. in stainless steel 304 (V2A)	7306XXB62			
Cooling capacity A35A10 (200 l/h)	700 W			
Coolant	Water, light oils or similar			
Operating temperature range	1°C - 60°C			
Air flow volume (system / unimpeded) ¹⁾	110 / 220 m ³ /h			
Mounting	Wall mounted / recessed			
Dimensions A x B x C (D+E)	370 x 520 x 131 (37+94) mm			
Housing material / colour	Mild steel powder coated, RAL 7035			
Weight	7.5 kg	8.5 kg	7.5 kg	8.5 kg
Max. working pressure water circuit	10 bar			
Water connection	Rp 3/8" internal thread (with optional connections for internal pipe Ø of 10 mm)			
ELECTRICAL DATA				
Voltage / Frequency	120 - 230 V ~ 50/60 Hz	230 V ~ 50/60 Hz	380/415 V 50 Hz 2~ 400/460 V 60 Hz 2~	380/415 V 50 Hz 2~ 400/460 V 60 Hz 2~
Max. current ²⁾	0.25 / 0.35 A	0.35 A	0.2 A	0.25 A
Starting current ²⁾	1.0 / 1.4 A	1.4 A	0.8 A	1.0 A
Max. power	15 W	30 W	20 W	35 W
Fuse rating	1 A (T)			
Connection	4 - pole connector for power, 5 - pole connector for signals			
Ingress protection	IP 55 / Type 12 (with gasket kit expandable to Type 3, 3R, 4 and 4X for stainless steel models)			
Certification	CE, cURus, cULus			

¹⁾ Enclosure

²⁾ Values for 50/60 Hz

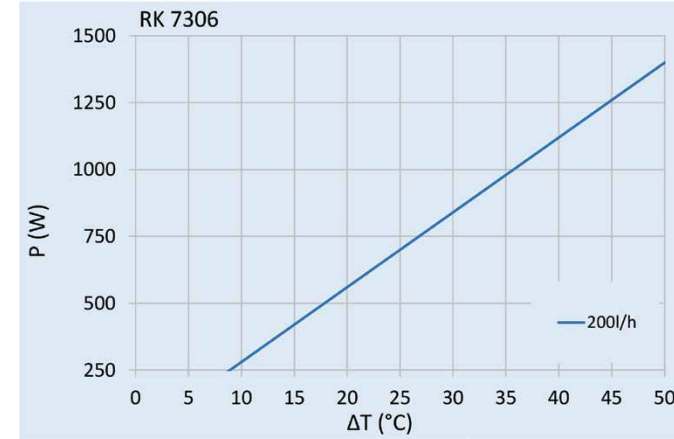

ΔT = Temperature difference between enclosure air and coolant

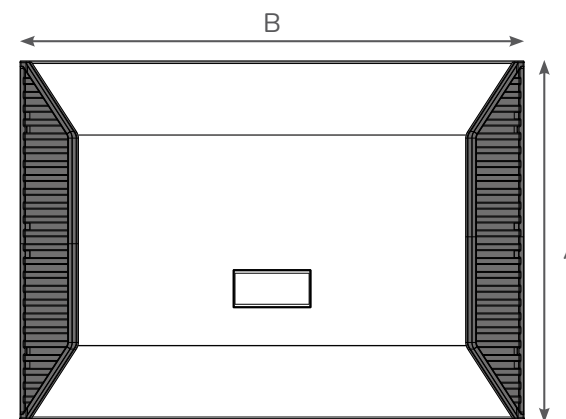
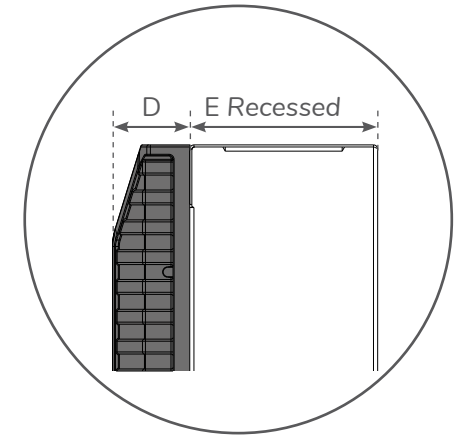

RK 7306

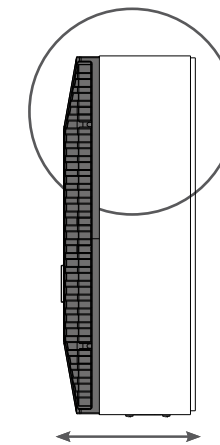

C Wall mounted



SLIMLINE HEX

Air / water heat exchanger

RK 7512

- ✓ Cooling capacity: 1.3 kW
- ✓ An optimal way of cooling when a cold water supply is readily available
- ✓ Maintenance free
- ✓ Wall or recess mounting
- ✓ Different cold air outlet openings
- ✓ Cutout compatible with SLIMLINE PRO cooling units KG 8508, KG 8512 and KG 8412 (page 24)

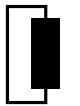

Model	RK 7512			
Order number	751200B001		751220B001	
Order no. with controller & magnetic valve		751201B001		751221B001
Order no. in stainless steel 304 (V2A)	7512XXB62			
Cooling capacity L35W10 (200 l/h)	1.3 kW			
Coolant	Water, light oils or similar			
Operating temperature range	1°C - 60°C			
Air flow volume (system / unimpeded) ¹⁾	330 / 500 m³/h			
Mounting	Wall mounted / recessed			
Dimensions A x B x C (D+E)	950 x 305 x 192 (37+155) mm			
Housing material / colour	Mild steel powder coated, RAL 7035			
Weight	16 kg	17 kg	16 kg	17 kg
Max. working pressure water circuit	10 bar			
Water connection	Rp 3/8" internal thread (with optional connections for internal pipe Ø of 10 mm)			
ELECTRICAL DATA				
Voltage / Frequency	230 V ~ 50/60 Hz	230 V ~ 50/60 Hz	380-415 V 50 Hz 3~ 400-460 V 60 Hz 3~	380-415 V 50 Hz 3~ 400-460 V 60 Hz 3~
Max. current ²⁾	0.3 / 0.4 A	0.4 / 0.5 A	0.2 / 0.2 A	0.3 / 0.3 A
Starting current ²⁾	0.4 / 0.5 A	0.5 / 0.5 A	0.4 / 0.4 A	0.6 / 0.6 A
Max. power ²⁾	60 / 80 W	75 / 90 W	60 / 80 W	80 / 100 W
Fuse rating	1 A (T)			
Connection	4 - pole connector for power, 5 - pole connector for signals			
Ingress protection	IP 55 / Type 12 (with gasket kit expandable to Type 3, 3R, 4 and 4X for stainless steel models)			
Certification	CE, cURus, cULus			

¹⁾ Enclosure

²⁾ Values for 50/60 Hz

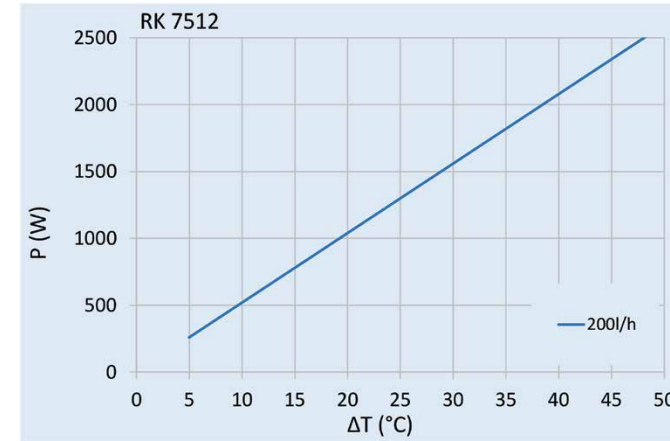

ΔT = Temperature difference between enclosure air and coolant

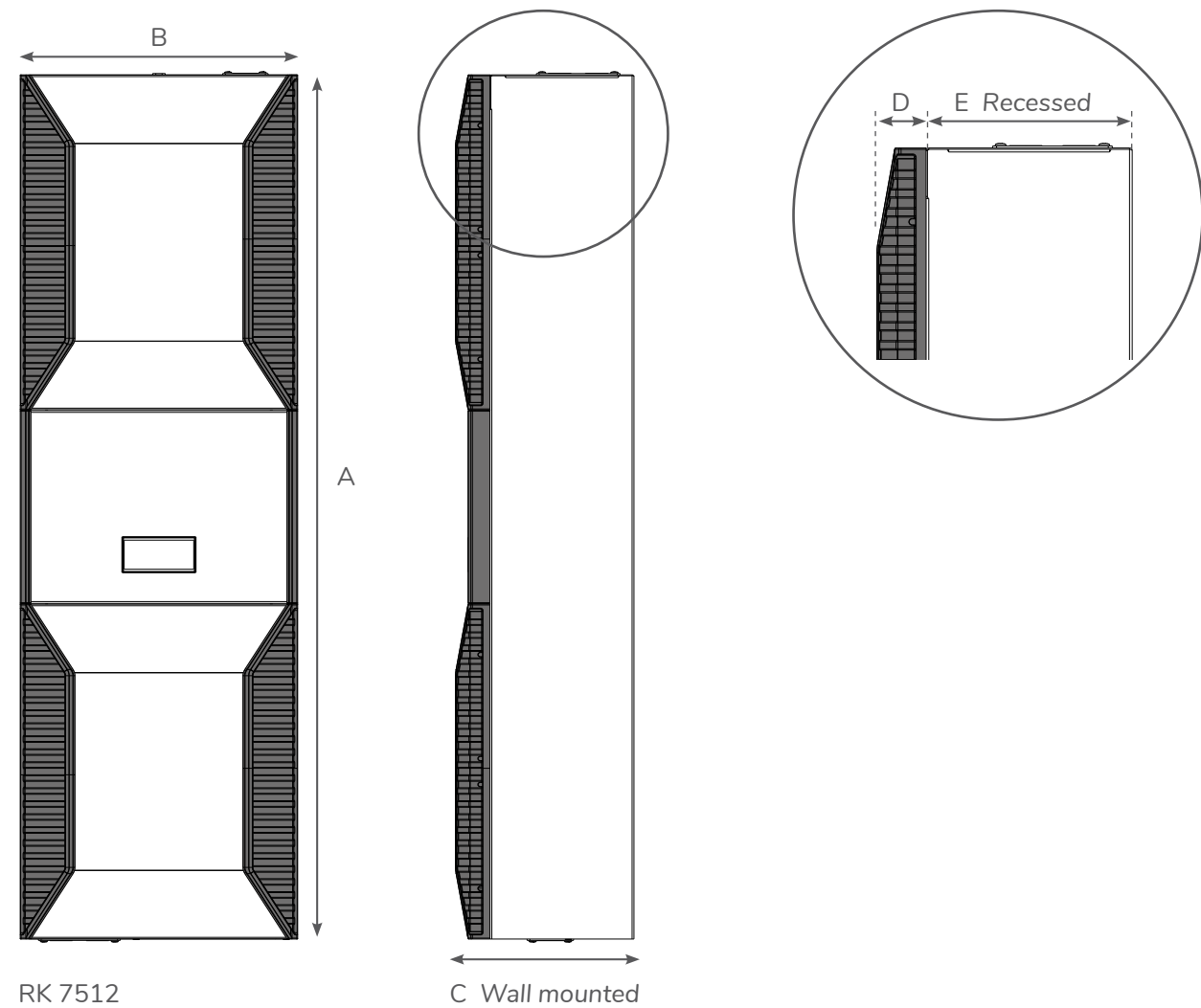



SLIMLINE HEX

Air / water heat exchanger

RK 7525

- ✓ Cooling capacity: 2.8 kW
- ✓ An optimal way of cooling when a cold water supply is readily available
- ✓ Maintenance free
- ✓ Wall or recess mounting
- ✓ Different cold air outlet openings
- ✓ Cutout compatible with SLIMLINE PRO cooling units KG 8515, KG 8520 and KG 8525 (pages 26, 28)

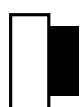

Model	RK 7525			
Order number	752500B001		752520B001	
Order no. with controller & magnetic valve		752501B001		752521B001
Order no. in stainless steel 304 (V2A)	7525XXB62			
Cooling capacity L35W10 (500 l/h)	2.8 kW			
Coolant	Water, light oils or similar			
Operating temperature range	1°C - 60°C			
Air flow volume (system / unimpeded) ¹⁾	560 / 800 m ³ /h			
Mounting	Wall mounted / recessed			
Dimensions A x B x C (D+E)	1,350 x 395 x 192 (37+155) mm			
Housing material / colour	Mild steel powder coated, RAL 7035			
Weight	28 kg	29 kg	28 kg	29 kg
Max. working pressure water circuit	10 bar			
Water connection	Rp 1/2" internal thread (with optional connections for internal pipe Ø of 13 mm)			
ELECTRICAL DATA				
Voltage / Frequency	230 V ~ 50/60 Hz	230 V ~ 50/60 Hz	380-415 V 50 Hz 3~ 400-460 V 60 Hz 3~	380-415 V 50 Hz 3~ 400-460 V 60 Hz 3~
Max. current ²⁾	0.4 / 0.5 A	0.5 / 0.6 A	0.2 / 0.2 A	0.3 / 0.3 A
Starting current ²⁾	0.6 / 0.6 A	0.6 / 0.7 A	0.4 / 0.4 A	0.5 / 0.5 A
Max. power ²⁾	90 / 110 W	105 / 125 W	70 / 105 W	90 / 125 W
Fuse rating	1 A (T)			
Connection	4 - pole connector for power, 5 - pole connector for signals			
Ingress protection	IP 55 / Type 12 (with gasket kit expandable to Type 3, 3R, 4 and 4X for stainless steel models)			
Certification	CE, cURus, cULus			

¹⁾ Enclosure

²⁾ Values for 50/60 Hz

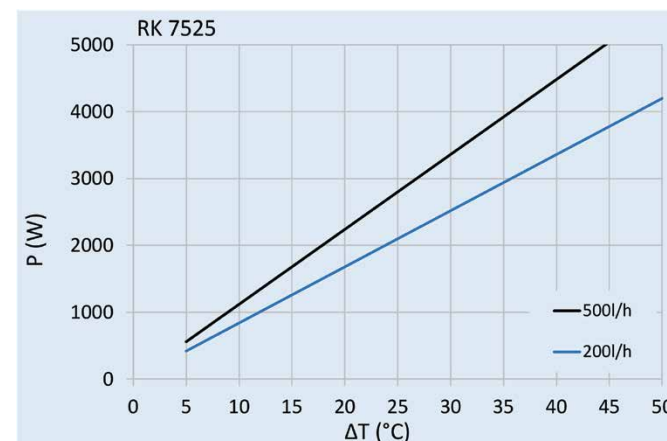

ΔT = Temperature difference between enclosure air and coolant

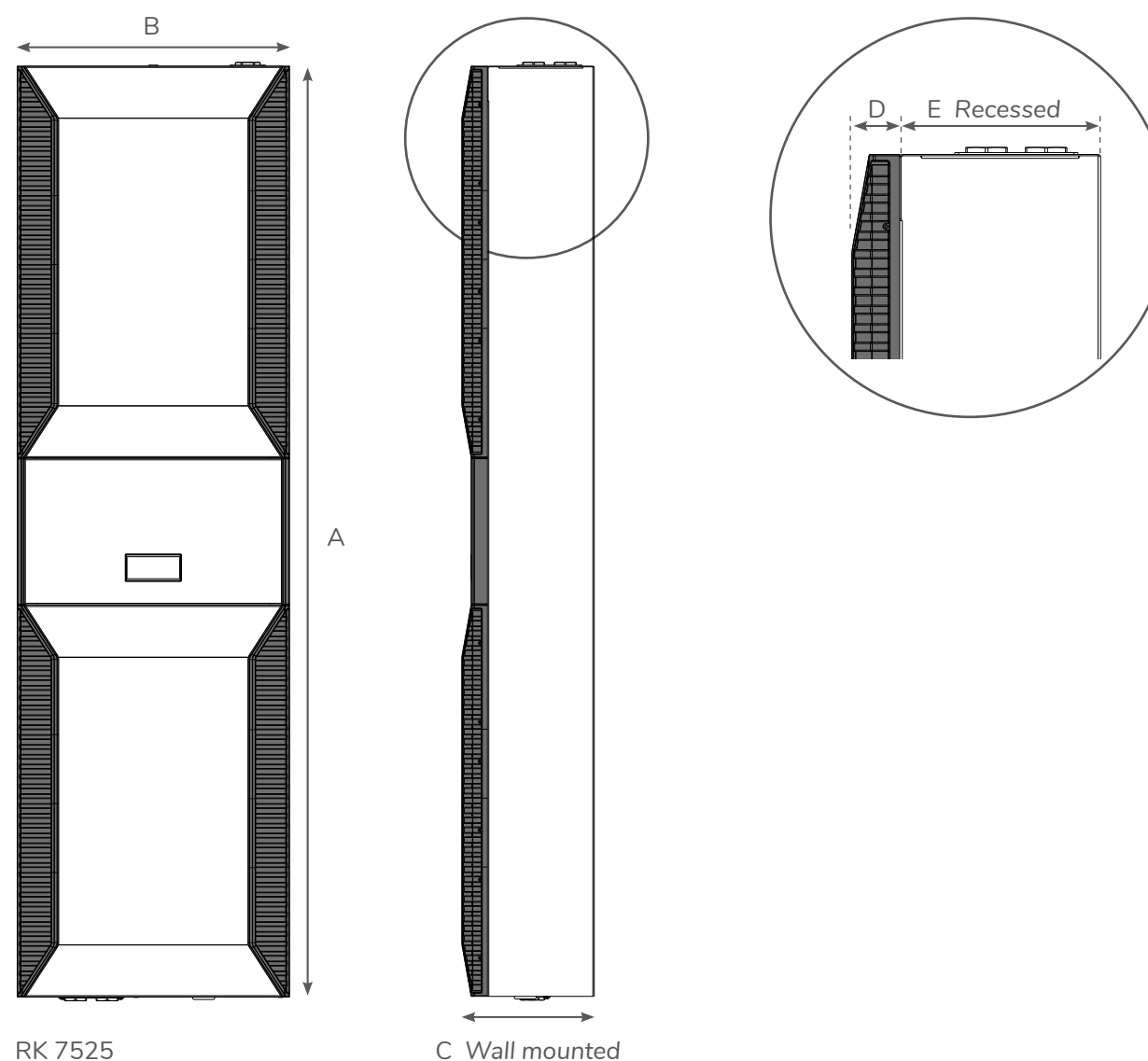



SLIMLINE HEX

Air / water heat exchanger

RK 7555

- ✓ Cooling capacity: 5.5 kW
- ✓ An optimal way of cooling when a cold water supply is readily available
- ✓ Maintenance free
- ✓ Wall or recess mounting
- ✓ Different cold air outlet openings
- ✓ Cutout compatible with SLIMLINE PRO cooling units KG 8540 and KG 8562 (page 28)

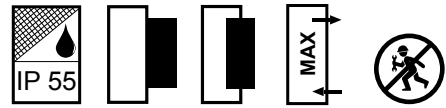

Model	RK 7555			
Order number	755500B001		755520B001	
Order no. with controller & magnetic valve		755501B001		755521B001
Order no. in stainless steel 304 (V2A)	7555XXB62			
Cooling capacity L35W10 (800 l/h)	5.5 kW			
Coolant	Water, light oils or similar			
Operating temperature range	1°C - 60°C			
Air flow volume (system / unimpeded) ¹⁾	780 / 1,100 m³/h			
Mounting	Wall mounted / recessed			
Dimensions A x B x C (D+E)	1,550 x 455 x 232 (37+195) mm			
Housing material / colour	Mild steel powder coated, RAL 7035			
Weight	38 kg	39 kg	38 kg	39 kg
Max. working pressure water circuit	10 bar			
Water connection	Rp 1/2" internal thread (with optional connections for internal pipe Ø of 13 mm)			
ELECTRICAL DATA				
Voltage / Frequency	230 V ~ 50/60 Hz	230 V ~ 50/60 Hz	380-415 V 50 Hz 3~ 400-460 V 60 Hz 3~	380-415 V 50 Hz 3~ 400-460 V 60 Hz 3~
Max. current ²⁾	0.7 / 1.1 A	0.8 / 1.2 A	0.3 / 0.4 A	0.4 / 0.5 A
Starting current ²⁾	1.3 / 1.4 A	1.4 / 1.5 A	0.8 / 0.9 A	0.9 / 1.0 A
Max. power ²⁾	160 / 225 W	175 / 240 W	150 / 230 W	170 / 250 W
Fuse rating	2 A (T)		1 A (T)	2 A (T)
Connection	4 - pole connector for power, 5 - pole connector for signals			
Ingress protection	IP 55 / Type 12 (with gasket kit expandable to Type 3, 3R, 4 and 4X for stainless steel models)			
Certification	CE, cURus, cULus			

¹⁾ Enclosure

²⁾ Values for 50/60 Hz

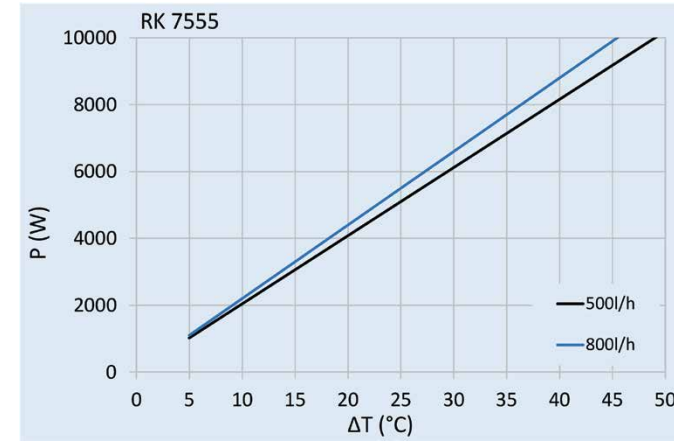

ΔT = Temperature difference between enclosure air and coolant

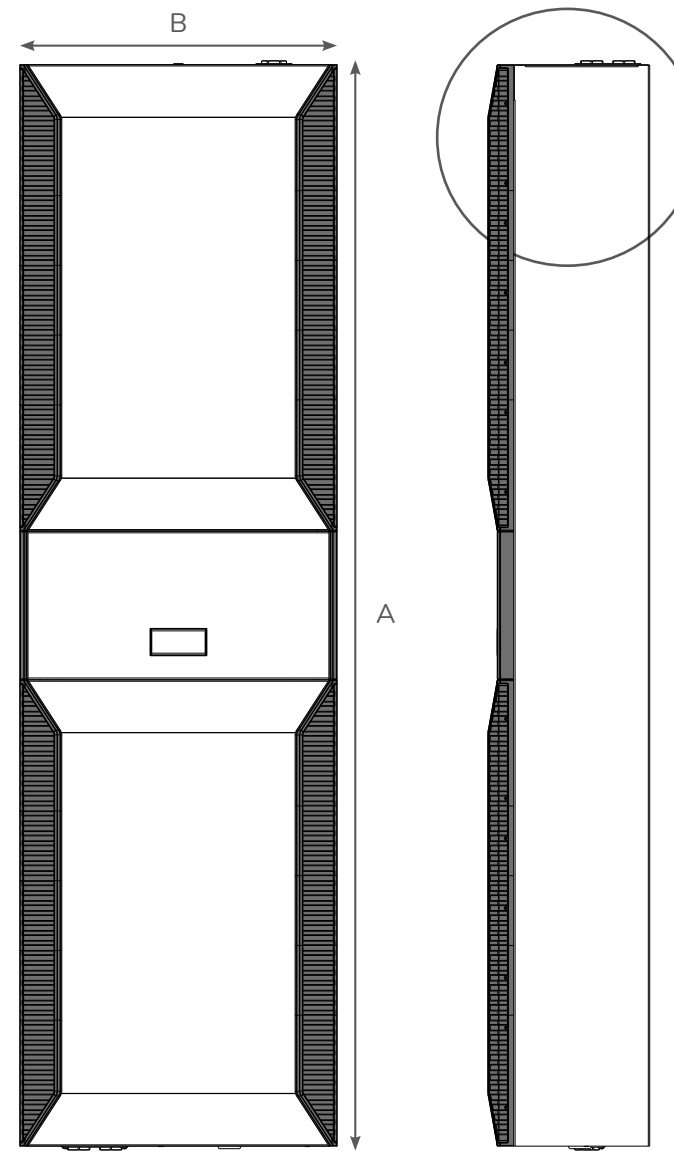

RK 7555

C Wall mounted

HEAT EXCHANGERS IN A COMPACT INDUSTRIAL DESIGN

SLIMLINE HEX air / water heat exchangers



COMPACT INDUSTRIAL DESIGN



PROTECTION CLASS IP 55

HEAT DISSIPATION IN A SAFE AND RELIABLE MANNER

SLIMLINE HEX air / water heat exchangers dissipate heat safely and reliably from industrial enclosures when a cold water connection is available.

They can be wall or internally mounted and installed in 19" racks (page 104). The compact design and with cooling capacities of up to 5 kW, makes the SLIMLINE HEX heat exchangers also suitable for smaller industrial enclosures.

For applications where hygiene or high corrosion protection is important, we offer our heat exchangers also with stainless steel water pipes.

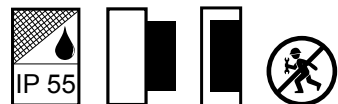



SLIMLINE HEX

Air / water heat exchanger

RK 2300

- ✓ Cooling capacity: 350 W
- ✓ An optimal way of cooling when a cold water supply is readily available
- ✓ Maintenance free
- ✓ Compact design, suitable for small enclosures
- ✓ Wall or internal mounting



Model	RK 2300		
Order number	2300010	2300110	2300310
Order no. in stainless steel 304 (V2A)	2300XX2		
Cooling capacity L35W10 (200 l/h)	350 W		
Coolant	Water, light oils or similar		
Operating temperature range	1°C - 65°C		
System air flow ¹⁾	74 / 215 m ³ /h @ 50 Hz	85 / 240 m ³ /h	70 / 377 m ³ /h
Unimpeded air flow ¹⁾	85 / 240 m ³ /h @ 60 Hz		
Dimensions (A x B x C)	303 x 153 x 84 mm		
Mounting	Wall mounted / internal		
Housing material / colour	Mild steel powder coated, RAL 7035		
Weight	3.2 kg	4.5 kg	3.2 kg
Max. working pressure water circuit	10 bar		
Water connection	Rp 1/4" internal thread (with optional connections for internal pipe Ø of 13 mm)		
ELECTRICAL DATA			
Voltage / Frequency	230 V ~ 50/60 Hz	120 V ~ 60 Hz	24 V DC
Starting current	0.35 A	0.74 A	5 A
Max. current	0.24 A	0.49 A	0.78 A
Max. power	37 W	38 W	19 W
Fuse rating	4 A (T)		1 A (T)
Connection	Terminal block		
Ingress protection	IP 55		
Certification	CE, cURus		

¹⁾ Ambient / enclosure

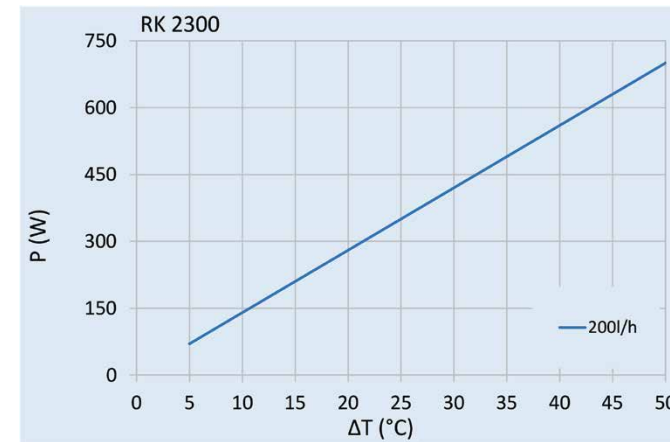

ΔT = Temperature difference between enclosure air and coolant

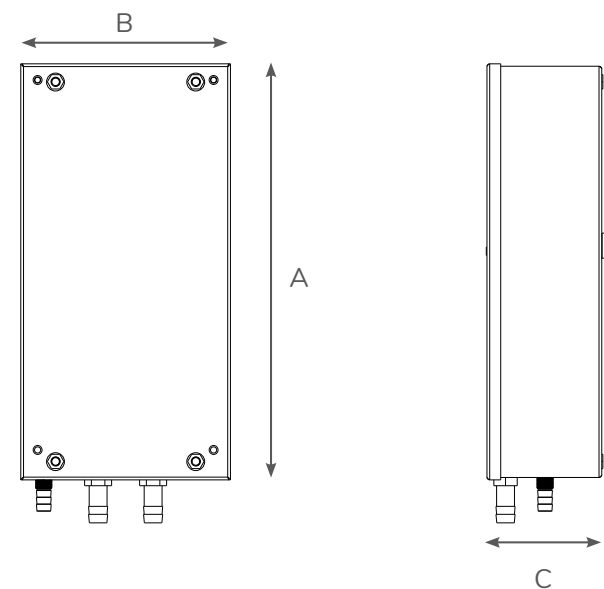



SLIMLINE HEX

Air / water heat exchanger

RK 2114 A 400 / B 400 - RK 2114 A 632

- ✓ Cooling capacity: 650 W
- ✓ An optimal way of cooling when a cold water supply is readily available
- ✓ Maintenance free
- ✓ Compact design, suitable for small enclosures
- ✓ Wall or internal mounting



Model	RK 2114 A 400 / B 400				
Order no. wall mounting (A 400)	2114003	2114103	2114203	2114303	2114403
Order no. internal mounting (B 400)	2114002	2114102	2114202	2114302	2114402
Order no. in stainless steel 304 (V2A)	2114XXX2				
Cooling capacity L35W10 (200 l/h)	650 W				
Cooling capacity L35W10 (500 l/h)	750 W				
Coolant	Water, light oils or similar				
Operating temperature range	1°C - 72°C				
System air flow ¹⁾	180 / 460 m ³ /h @ 50 Hz	200 / 565 m ³ /h	180 / 460 m ³ /h @ 50 Hz	190 / 560 m ³ /h	
Unimpeded air flow ¹⁾	200 / 535 m ³ /h @ 60 Hz		200 / 535 m ³ /h @ 60 Hz		
Dimensions (H x W x D)	400 x 212 x 80 mm				
Mounting	Wall mounted / internal				
Housing material / colour	Mild steel powder coated, RAL 7035				
Weight	4.5 kg				
Max. working pressure water circuit	10 bar				
Water connection	Rp 1/4" internal thread with optional connections for internal pipe Ø of 10 mm				
ELECTRICAL DATA					
Voltage / Frequency	230 V ~ 50/60 Hz	120 V ~ 60 Hz	400 V ~ 50/60 Hz	24 V DC	48 V DC
Starting current	1 A	2 A	0.6 A	6.8 A	-
Max. current	0.4 A	0.8 A	0.15 A	2.0 A	0.8 A
Max. power	80 W		90 W	50 W	34 W
Fuse rating	4 A (T)		3 x 1 A (T)	10 A (T)	4 A (T)
Connection	Connection cable 3 m (fixed, with connection strands)				
Ingress protection	IP 55				
Certification	CE, cURus				

¹⁾ Ambient / enclosure

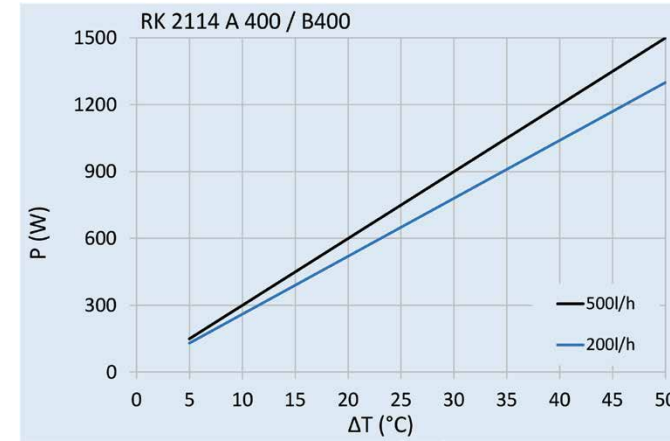

ΔT = Temperature difference between enclosure air and coolant

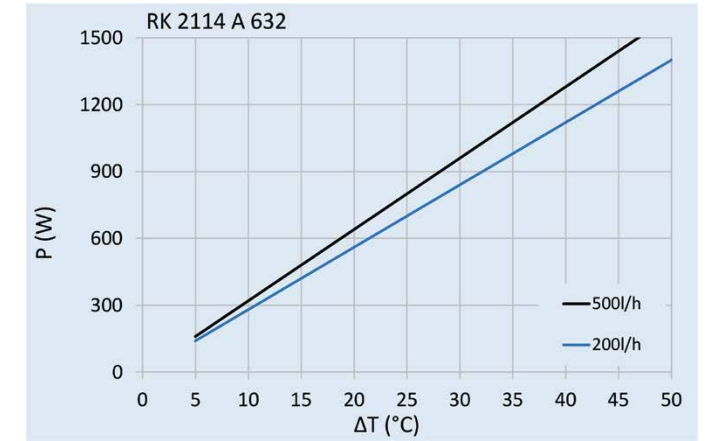

Model	RK 2114 A 632		
Order number	2114014	2114114	2114214
Order no. with proportional water flow regulator ¹⁾	21144004	2114104	2114204
Order no. in stainless steel 304 (V2A)	2114XXX2		
Cooling capacity L35W10 (200 l/h)	700 W		
Cooling capacity L35W10 (500 l/h)	800 W (only without water flow regulator)		
Coolant	Water, light oils or similar		
Operating temperature range	1°C - 72°C		
System air flow ²⁾	180 / 575 m ³ /h @ 50 Hz	200 / 625 m ³ /h	180 / 575 m ³ /h @ 50 Hz
Unimpeded air flow ²⁾	200 / 625 m ³ /h @ 60 Hz		200 / 625 m ³ /h @ 60 Hz
Dimensions (H x W x D)	632 x 212 x 80 mm		
Mounting	Wall mounted / internal		
Housing material / colour	Mild steel powder coated, RAL 7035		
Weight	5.5 kg		
Max. working pressure water circuit	10 bar		
Water connection	Rp 1/4" internal thread with optional connections for internal pipe Ø of 10 mm		
ELECTRICAL DATA			
Voltage / Frequency	230 V ~ 50/60 Hz	120 V ~ 60 Hz	400 V ~ 50/60 Hz
Starting current	1 A	2 A	0.6 A
Max. current	0.4 A	0.8 A	0.15 A
Max. power	80 W		90 W
Fuse rating	4 A (T)		3 x 1 A (T)
Connection	Connection cable 3 m (fixed, with connection strands)		
Ingress protection	IP 55		
Certification	CE, cURus		

¹⁾ Setting range 20°C - 50°C

²⁾ Ambient / enclosure



SLIMLINE HEX

Air / water heat exchanger

RK 2114 A 891 - RK 2100 - RK 2120

- ✓ Cooling capacity: 1.2 kW, 1.3 kW and 2.1 kW
- ✓ An optimal way of cooling when a cold water supply is readily available
- ✓ Maintenance free
- ✓ Compact design, suitable for small enclosures
- ✓ Wall or internal mounting



Model	RK 2114 A 891			RK 2100	RK 2120		
Order number	2114010	2114110	2114210	-	2120010	2120110	2120210
Order no. with proportional water flow regulator ¹⁾	2114000	2114100	2114200	-	-	-	-
Order no. with solenoid valve	-	-	-	2100000	2120000	2120100	2120200
Order no. in stainless steel 304 (V2A)	2114XXX2			2100XXX2	2120XXX2		
Cooling capacity L35W10 (200 l/h)	1.2 kW			1.3 kW	1.5 kW		
Cooling capacity L35W10 (500 l/h)	1.4 kW				2.1 kW		
Coolant	Water, light oils or similar						
Operating temperature range	1°C - 72°C						
System air flow ²⁾	200 / 625 m ³ /h			350 / 740 m ³ /h	518 / 920 m ³ /h		
Unimpeded air flow ²⁾	891 x 212 x 80 mm			525 x 303 x 136 mm	950 x 400 x 180 mm		
Dimensions (A x B x C)	891 x 212 x 80 mm			525 x 303 x 136 mm	950 x 400 x 180 mm		
Mounting	Wall mounted / internal			Wall mounted	Wall mounted / internal		
Housing material / colour	Mild steel powder coated, RAL 7035						
Weight	7 kg			11.5 kg	15 kg		
Max. working pressure water circuit	10 bar						
Water connection	Rp 1/4" internal thread with optional connections for internal pipe Ø of 10 mm			Pluggable bulkhead fitting Ø 10 mm	Rp 1/4" internal thread with optional connections for internal pipe Ø of 10 mm		
ELECTRICAL DATA							
Voltage / Frequency	230 V ~ 50/60 Hz	120 V ~ 60 Hz	400 V ~ 50/60 Hz 3~	230 V ~ 50/60 Hz	230 V ~ 50/60 Hz	120 V ~ 60 Hz	400 V ~ 50/60 Hz 2~
Starting current ³⁾	1 A	2 A	0.6 A	2.2 A	0.51 / 0.52 A	1 A	0.29 A
Max. current ³⁾	0.4 A	0.8 A	0.15 A	0.56 A	0.4 / 0.5 A	1 A	0.25 A
Max. power ³⁾	80 W		90 W	80 W	90 / 120 W	120 W	90 W
Fuse rating	4 A (T)		3 x 1 A (T)	4 A (T)	2 A (T)		
Connection	Connection cable 3 m (fixed, with strands)			Connection terminal	4 - pole connector for power 5 - pole connector for signals		
Ingress protection	IP 55						
Certification	CE, cURus						

¹⁾ Setting range 20°C - 50°C

²⁾ Ambient / enclosure

³⁾ Values for 50/60 Hz

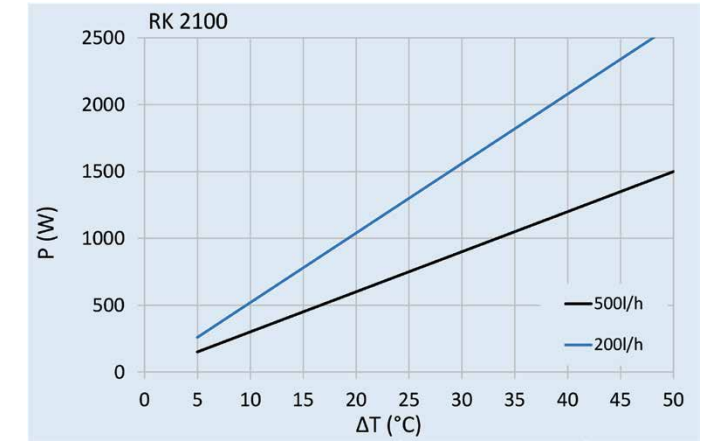
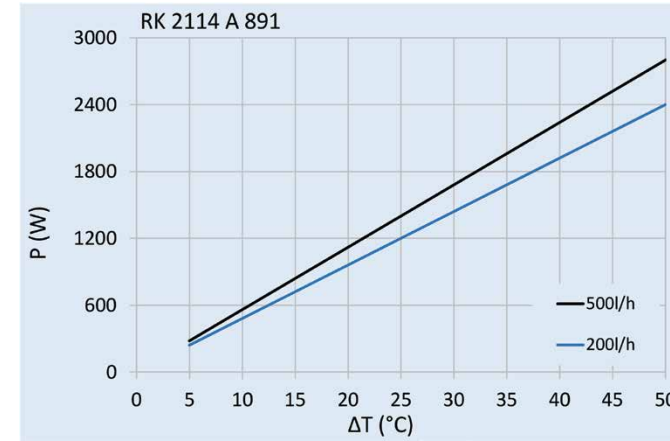

ΔT = Temperature difference between enclosure air and coolant

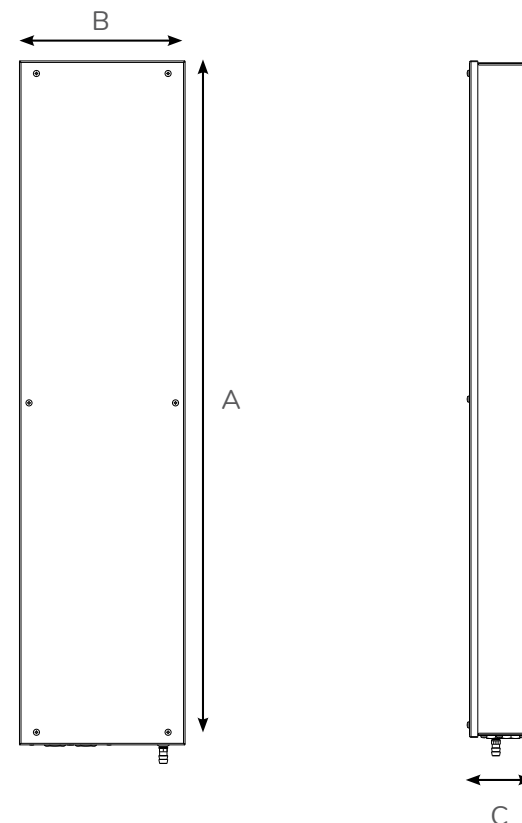
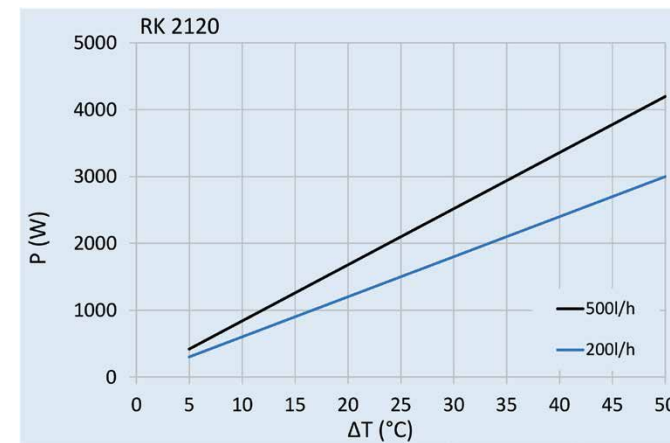

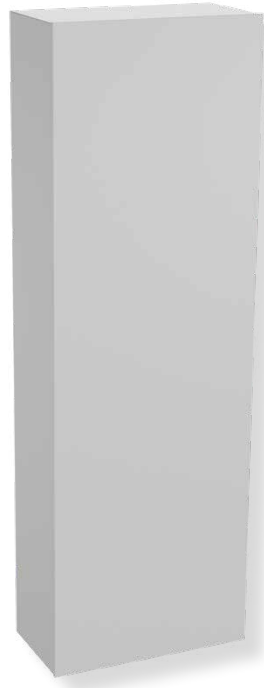

SLIMLINE HEX

Air / water heat exchanger

RK 2130 - RK 2149

- ✓ Cooling capacity: 3.15 kW and 4.8 kW
- ✓ An optimal way of cooling when a cold water supply is readily available
- ✓ Maintenance free
- ✓ Wall mounting

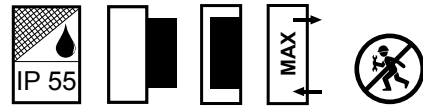

Model	RK 2130			RK 2149		
Order number	2130010	2130110	2130210	2149010	2149110	2149210
Order no. with solenoid valve	2130000	2130100	2130200	2149000	2149100	2149200
Order no. in stainless steel 304 (V2A)	2130XXX2			2149XXX2		
Cooling capacity L35W10 (200 l/h)	3.15 kW			4.8 kW		
Cooling capacity L35W10 (500 l/h)	4.15 kW			5.5 kW	5.6 kW	5.5 kW
Coolant	Water, light oils or similar					
Operating temperature range	1°C - 72°C					
System air flow ¹⁾	723 / 1,340 m ³ /h			980 / 1,500 m ³ /h		
Unimpeded air flow ¹⁾						
Dimensions (A x B x C)	950 x 400 x 180 mm			1,400 x 460 x 242 mm		
Mounting	Wall mounted / internal			Wall mounted		
Housing material / colour	Mild steel powder coated, RAL 7035					
Weight	17 kg			33 kg		
Max. working pressure water circuit	10 bar					
Water connection	Rp 1/4" internal thread with optional connections for internal pipe Ø of 10 mm			Rp 1/2" internal thread with optional connections for internal pipe Ø of 13 mm		
ELECTRICAL DATA						
Voltage / Frequency	230 V ~ 50/60 Hz	120 V ~ 60 Hz	400 V ~ 50/60 Hz 2~	230 V ~ 50/60 Hz	120 V ~ 60 Hz	380-415 V 50 Hz 3~ 400-460 V 60 Hz 3~
Starting current ²⁾	1.3 / 1.4 A	2.68 A	0.75 / 0.81 A	2.6 A	5 A	0.7 A / 0.9 A
Max. current ²⁾	0.7 / 1.1 A	2.15 A	0.4 / 0.65 A	1.3 A	2.6 A	0.35 A / 0.45 A
Max. power ²⁾	160 / 240 W	240 W	160 / 240 W	285 W	300 W	270 W
Fuse rating	2 A (T)	4 A (T)	2 A (T)	4 A (T)	6 A (T)	3 x 2 A (T)
Connection	4 - pole connector for power 5 - pole connector for signals			Connection terminal		
Ingress protection	IP 55					
Certification	CE, cURus					

¹⁾ Ambient / enclosure

²⁾ Values for 50/60 Hz

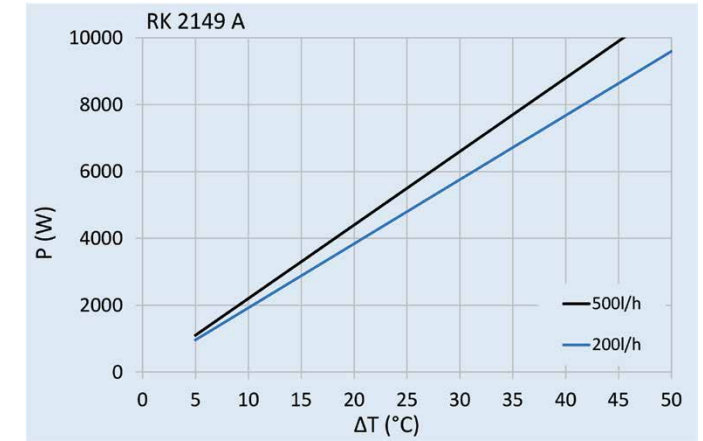
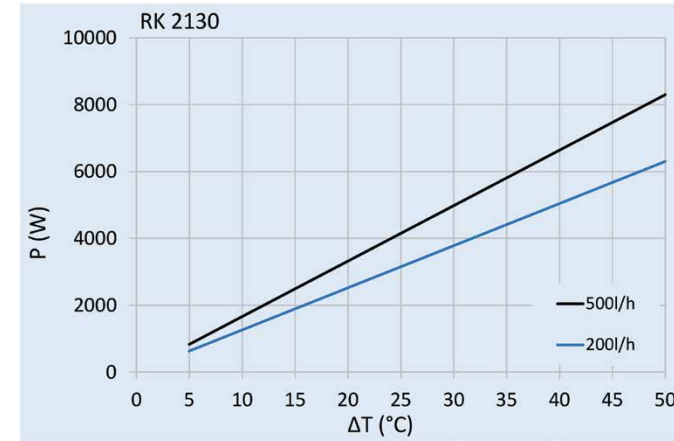

ΔT = Temperature difference between enclosure air and coolant

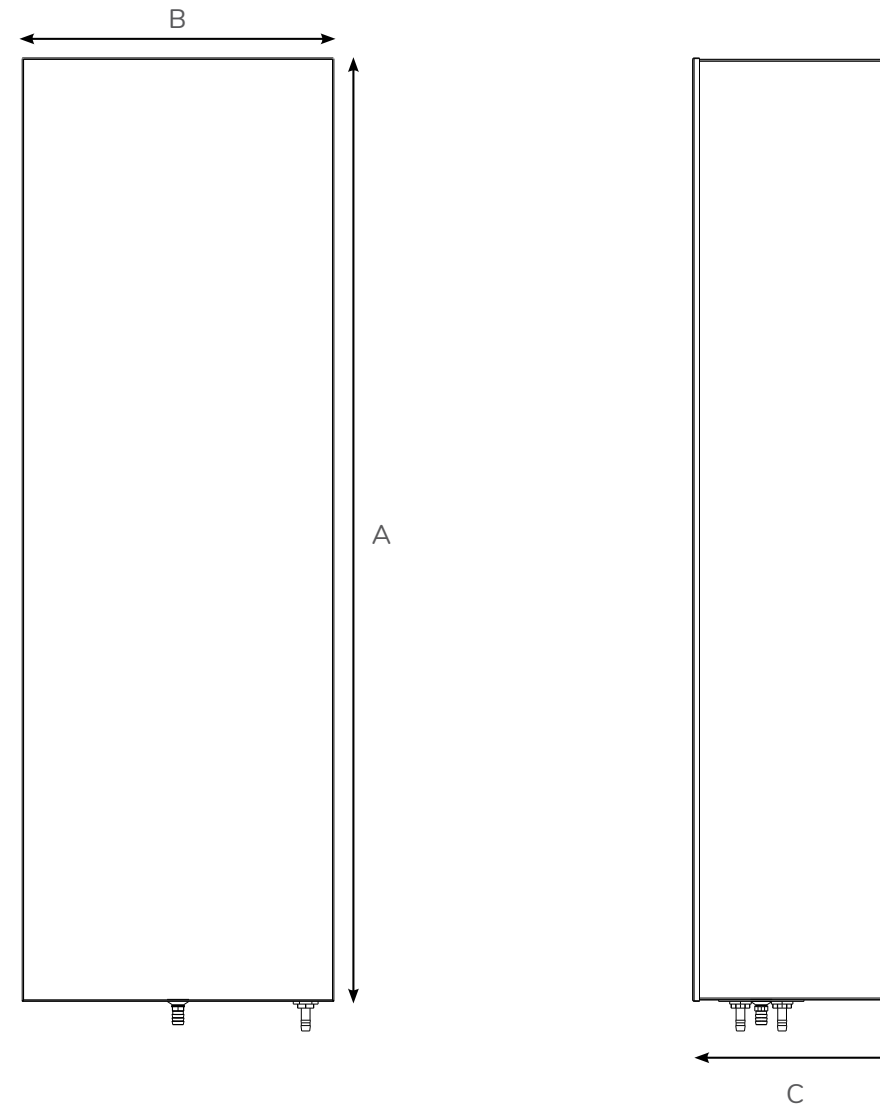

THE NEXT GENERATION OF INDUSTRIAL PROCESS COOLING

SOLITHERM CHILL



LIQUID COOLING FOR PLANTS AND MACHINES

Precise liquid cooling is the reliable heat dissipation solution for machines, machining centers, server applications, laser cooling and other industrial applications. It is one of the main requirements for the smooth running of industrial production processes.

Seifert Systems offers chillers with cooling capacities from 1.5 kW to 12 kW with various option packages adapted to the respective customer needs as necessary.



SOLITHERM CHILL

A new standard

For the first time, this new chiller series sets a standard for industrial applications: three different heights with eight different cooling capacities, always with the same basic foot print, allow a maximum of possibilities for industrial process and machine cooling.

SOLITHERM CHILL are available as:

- Air cooled
- Water cooled
- Passive water cooled

The cooling capacities range from 1.5 to 12 kW. All models have the same design, identical connections and are equipped with the same operating philosophy.

By using the new App, you can connect to each chiller via Bluetooth, read the performance data, control each parameter or re-configure the system settings.

Our chillers are also available with speed-controlled compressors and fans. This technology offers even more precise temperature control of the cooling medium with high efficiency values.

SOLITHERM CHILL, SLIMLINE HEX air / water heat exchangers and SLIMLINE PRO cooling units have a uniform design and thus always give you, the customer, the same appearance of your machines, regardless of the cooling type and cooling capacity. The air / water heat exchangers can be connected to our chillers quickly and easily.

Our chillers can be used to cool a single machine, supplying water to additional heat exchangers for cooling the electronics and cooling the spindle coolant.

In addition to the standards described, our chillers can always be adapted and optimised to suit your individual application.

MODELS AND OPTIONS

Model	RC 6502 / 03 / 04	RC 6505 / 07	RC 6508 / 10 / 12
Cooling capacity L35W18	1.5 / 2 / 3.5 kW	5 / 6.5 kW	7.5 / 10 / 12 kW
Coolant	Water, water / glycol mixtures or similar		
Refrigerant	R513A or R134a	R513A	
Capacity control	On / Off		
Operating temperature range (liquid)	10°C - 25°C		
Operating temperature range (ambient)	10°C - 50°C		
Coolant flow rate	15 l/min. @ 2.5 bar	20 l/min. @ 2.5 bar	30 l/min. @ 2.5 bar
Coolant tank volume	15 l	60 l	60 l
Mounting	Free standing (optional castor wheels)		
Dimension H x W x D mm	650 x 595 x 595	1,100 x 595 x 595	1,436 x 595 x 595 (RC 6508) 1,550 x 595 x 595 (RC 6510/12)
Housing material / colour	Mild steel, powder coated RAL 7035		
Water connection	2 x G3/4" back below		
Voltage / Frequency	230 V ~ 50/60 Hz 400/460 V 50/60 Hz 3~	400/460 V 50/60 Hz 3~	400/460 V 50/60 Hz 3~
Protection class	IP 54		
Certification	CE		

STANDARD PACKAGE

- Ensures efficient operation
- Includes different control and connection options

EFFICIENCY PACKAGE

- ON / OFF compressor
- Variable speed fan
- Electronic expansion valve
- Energy saving appr. 10 - 20%

EFFICIENCY PACKAGE+

- Variable speed compressor and fan for maximum efficiency and precise temperature control
- Temperature accuracy $\pm 0.1^\circ\text{C}$

OUTDOOR PACKAGE

- Compressor heater
- Condenser pressure sensor
- Evaporation pressure sensor
- Return water temperature sensor
- Fan control depending on the condensing temperature
- Pump protection cover
- Electric housing heater

COMMUNICATION PACKAGE

- RS 485 interface for MODBUS
- M12 connector for communication mounted on chiller

OPTIONAL ADD-ONS

- Customised electrical connection
- Ambient temperature control
- Hot gas bypass
- Overflow prevention for low level installation
- Expansion Medium Emulsion or oil

These options cannot be retrofitted, but can only be delivered ex works when ordered.

CUSTOM MADE CHILLERS OFFER THE BEST FLEXIBILITY

We can supply chillers equipped with the following optional features:

- Electronic temperature control with standard ON / OFF function
- Hot gas bypass option for precise and quick temperature control
- Automatic mechanical pressure control valve
- Speed controlled compressors and electronic expansion valves
- Advanced remote fault monitoring system
- Possibility of several cooling circuits with flow control valves

USING THE THERMAL ENERGY OF THE AIR EFFICIENTLY

SLIMLINE HEX air / air heat exchanger



CONTROLLER WITH DISPLAY

CORROSION PROTECTED
HEAT EXCHANGER ELEMENT

METAL HOUSING
OPTIONAL STAINLESS STEEL

PROTECTION CLASS
UP TO IP 56

AIR / AIR HEAT EXCHANGERS FOR A STABLE ENCLOSURE CLIMATE

The functional principle of an air / air heat exchanger is quite simple. The heat exchanger core transfers the heat from the internal circuit to the ambient circuit through an aluminum surface, so there is no direct contact or mix between internal and external air.

SLIMLINE HEX air / air heat exchangers are suitable for both indoor and outdoor applications from a heat exchanger performance of 65 W/K onwards.

Air / air heat exchangers are used when there is no need to cool below the ambient temperature and the ambient air should not enter the enclosure due to contamination or humidity.

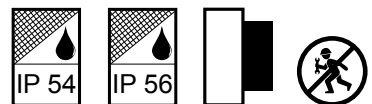



SLIMLINE HEX AIR

Air / air heat exchanger

LT 58007 - LT 58014

- ✓ Suitable for indoor applications
- ✓ Controller with display
- ✓ Protection class IP 54
- ✓ Maintenance free

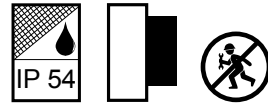

Model	LT 58007		LT 58014	
Order number	580070001	580071001	580140001	580141001
Order no. in stainless steel 304 (V2A)	58007XX2		58014XX2	
Heat exchanger performance	7 W/K		14 W/K	
Operating temperature range	-5°C - 55°C			
System air flow ¹⁾	76 / 87 m ³ /h		119 / 96 m ³ /h	
Unimpeded air flow ¹⁾	300 / 300 m ³ /h		300 / 300 m ³ /h	
Dimensions (A x B x C)	508 x 196.5 x 152 mm		749 x 254 x 151 mm	
Mounting	Wall mounted			
Housing material / colour	Mild steel powder coated / RAL 7035			
Weight	7.5 kg		11 kg	
ELECTRICAL DATA				
Voltage / Frequency	230 V ~ 50/60 Hz	120 V ~ 60 Hz	230 V ~ 50/60 Hz	120 V ~ 60 Hz
Starting current	1.3 A		1.3 A	
Max. current	0.6 A	1.1 A	0.6 A	1.1 A
Max. power	65 W		120 W	
Fuse rating	1 A (T)	1.6 A (T)	1 A (T)	1.6 A (T)
Connection	8 - pole connector			
Ingress protection	IP 54, NEMA 3, 3R			
Certification	CE, cURus			

¹⁾ Ambient / enclosure

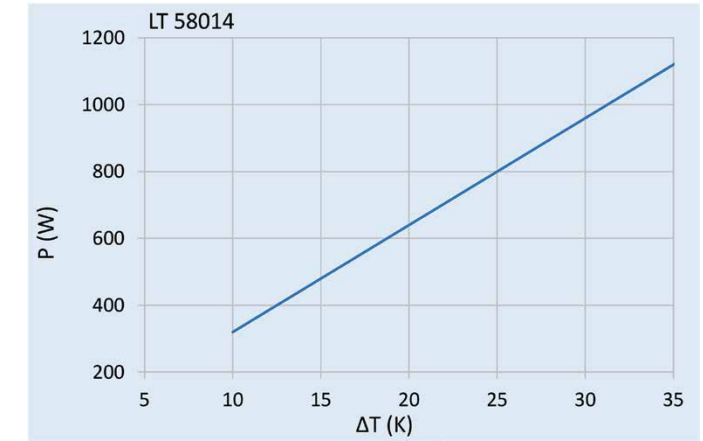
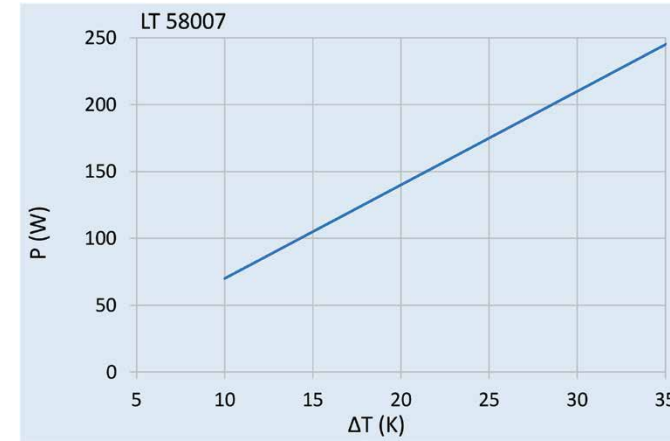

ΔT = Temperature difference between enclosure air and ambient air

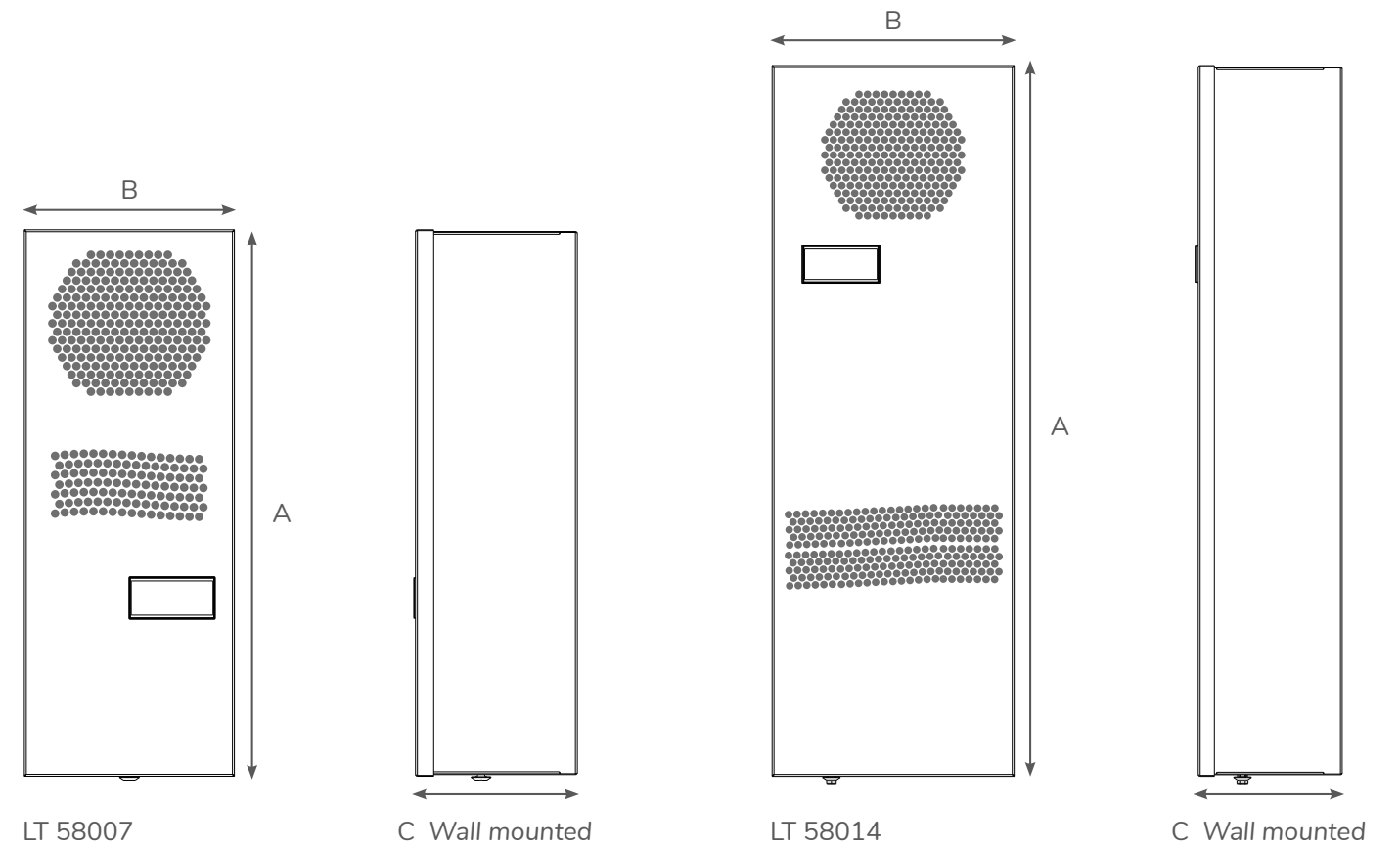



SLIMLINE HEX AIR

Air / air heat exchanger

LT 58032 - LT 58043

- ✓ Suitable for indoor applications
- ✓ Controller with display
- ✓ Protection class IP 54
- ✓ Maintenance free

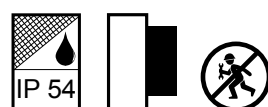

Model	LT 58032		LT 58043	
Order number	580320001	580321001	580430001	580431001
Order no. in stainless steel 304 (V2A)	58032XX2		58043XX2	
Heat exchanger performance	32 W/K		43 W/K	
Operating temperature range	-5°C - 55°C			
System air flow ¹⁾	250 / 255 m ³ /h		310 / 310 m ³ /h	
Unimpeded air flow ¹⁾	550 / 550 m ³ /h		850 / 850 m ³ /h	
Dimensions (A x B x C)	750 x 254 x 151 mm		1,194 x 254 x 151.3 mm	
Mounting	Wall mounted			
Housing material / colour	Mild steel powder coated / RAL 7035			
Weight	12 kg		16.7 kg	
ELECTRICAL DATA				
Voltage / Frequency	230 V ~ 50/60 Hz	120 V ~ 60 Hz	230 V ~ 50/60 Hz	120 V ~ 60 Hz
Starting current	1.6 A		2.0 A	2.2 A
Max. current	0.6 A	1.4 A	0.9 A	1.8 A
Max. power	150 W		195 W	
Fuse rating	1 A (T)	3 A (T)	1.6 A (T)	3 A (T)
Connection	8 - pole connector			
Ingress protection	IP 54, NEMA 3, 3R			
Certification	CE, cURus			

¹⁾ Ambient / enclosure

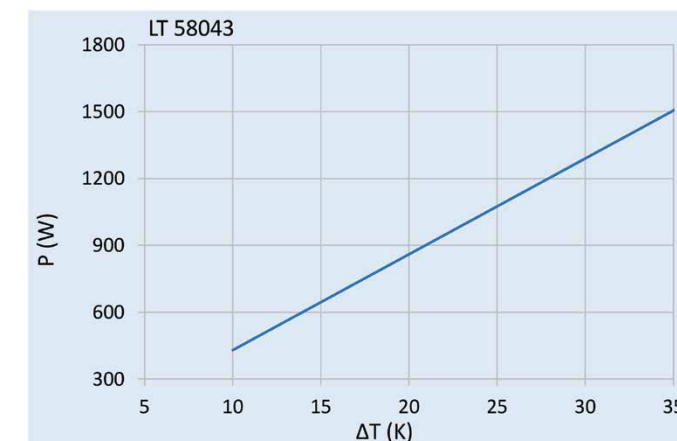
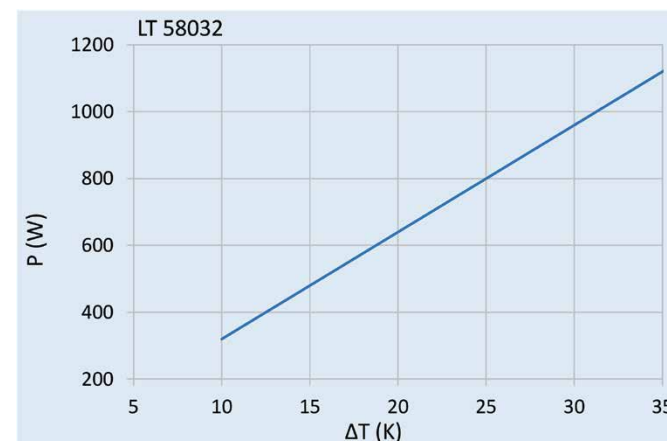

ΔT = Temperature difference between enclosure air and ambient air

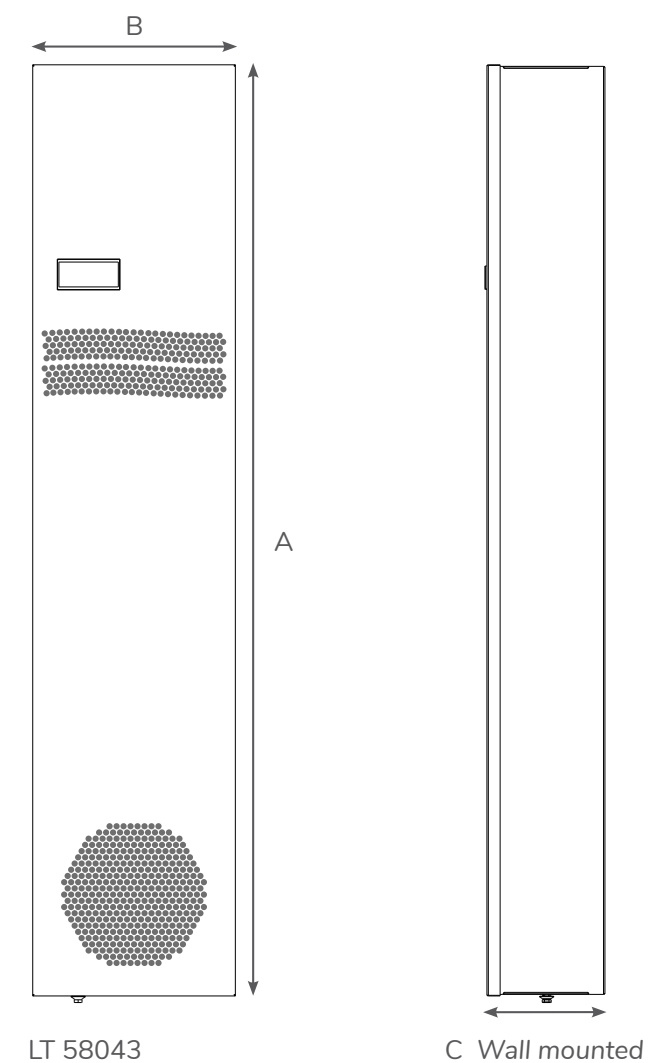
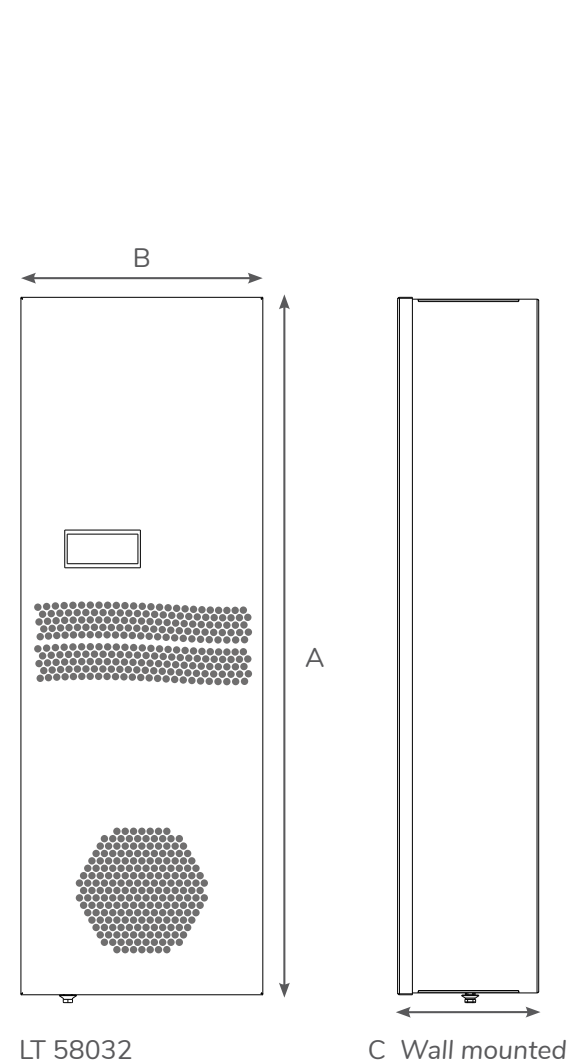



SLIMLINE HEX AIR

Air / air heat exchanger

LT 58065 - LT 58100 - LT 58180

- ✓ Suitable for indoor and outdoor applications
- ✓ Controller with display (enclosure side)
- ✓ Protection class IP 56
- ✓ Maintenance free

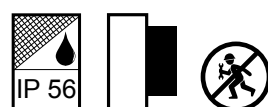

Model	LT 58065		LT 58100		LT 58180
Order number	580650001	580651001	581000001	581001001	581800001
Order no. in stainless steel 304 (V2A)	58065XX2		581X0XX2		
Heat exchanger performance	65 W/K		100 W/K		180 W/K
Operating temperature range	-25°C - 65°C				
System air flow ¹⁾	470 / 480 m ³ /h		525 / 500 m ³ /h		990 / 1050 m ³ /h
Unimpeded air flow ¹⁾	550 / 550 m ³ /h		1,000 / 1,000 m ³ /h		1,400 / 1,400 m ³ /h
Dimensions (A x B x C)	914.4 x 460 x 173 mm		914.4 x 460 x 218 mm		1,524 x 609.6 x 356 mm
Mounting	Wall mounted				
Housing material / colour	Mild steel powder coated / RAL 7035				
Weight	25 kg		25.5 kg		55 kg
ELECTRICAL DATA					
Voltage / Frequency	230 V ~ 50/60 Hz	120 V ~ 60 Hz	230 V ~ 50/60 Hz	120 V ~ 60 Hz	230 V ~ 50/60 Hz
Starting current	5.6 A	8 A	6 A	12 A	6 A
Max. current	1.3 A	3 A	2 A	4 A	2.7 A
Max. power ²⁾	205 / 270 W	270 W	287 / 460 W	460 W	460 W / 620 W
Fuse rating	2.5 A (T)	5 A (T)	4 A (T)	6.3 A (T)	4 A (T)
Connection	4 - pole connector for power, 5 - pole connector for signals				
Ingress protection	IP 56, NEMA 12, 3, 3R, 4 (4X in stainless steel)				
Certification	CE				

¹⁾ Ambient / enclosure

²⁾ Values for 50/60 Hz

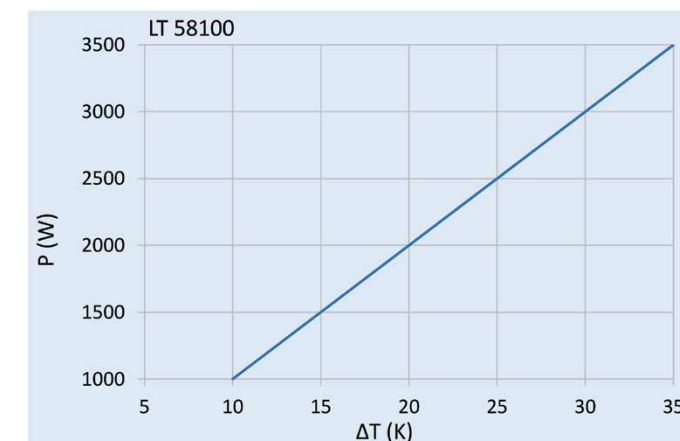
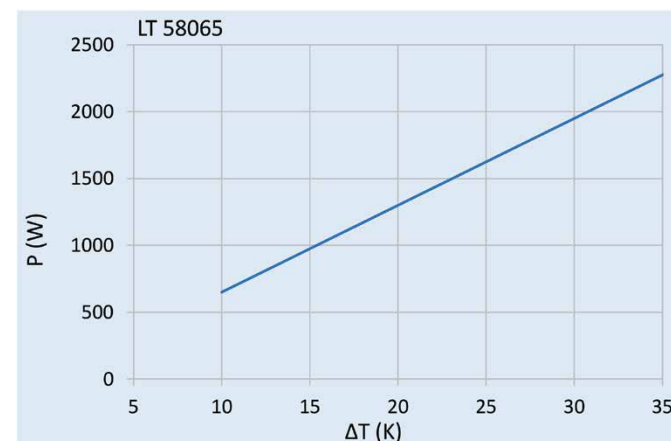

ΔT = Temperature difference between enclosure air and ambient air

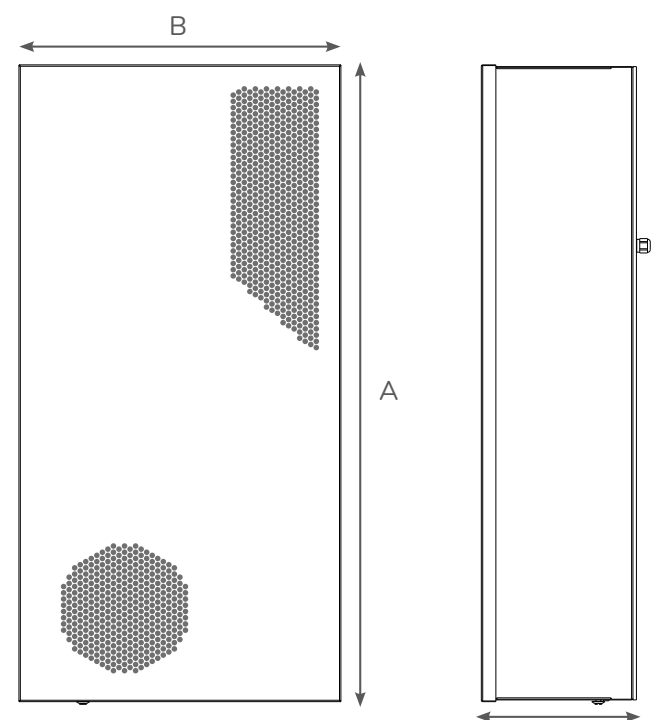

LT 58065 / 58100 / 58180

C Wall mounted

THE RIGHT VENTILATION FOR YOUR ENCLOSURE

SOLIFLEX filter fans & exhaust filters



FOR SAFE AND RELIABLE ENCLOSURE AIR CIRCULATION

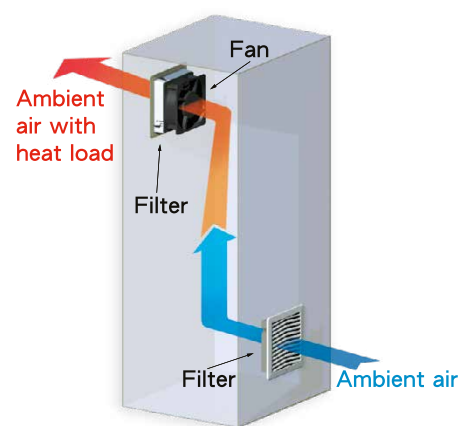

Fig.1 Exhaust system

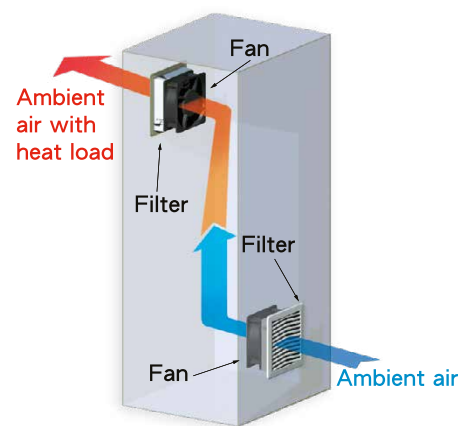

Fig. 2 Pressure & exhaust system

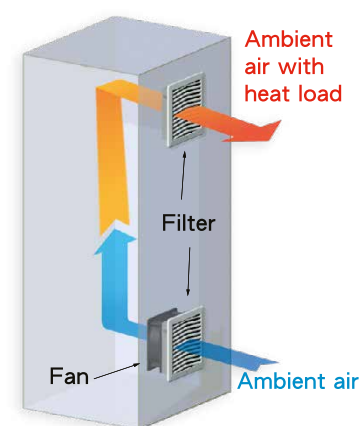

Fig. 3 Pressure system

SOLIFLEX filter fans and exhaust filters effectively ventilate enclosures and control panels if the ambient temperature is lower than the internal enclosure temperature. Combined with thermostats, additional energy can be saved. The fan only operates when it is actually needed.

Filter fans should be used to blow the cool ambient air into the enclosure (Fig. 2 and 3). This ensures that a slight positive pressure builds up inside the enclosure and that only filtered air flows inside it. The cold air blown into the enclosure displaces the warm air which exits through the exhaust filter.

If however air is drawn out of the enclosure by suction power (Fig. 1), only filtered ambient air should enter the enclosure. Ensure that no unfiltered air can enter through poor seals or cable entries.

If a combination of filter fan and exhaust filter is used, the filter fan should always be placed in the lower part of the enclosure, while the exhaust filter should be installed in the upper part to prevent heat pockets inside the enclosure.

SOLIFLEX filter fans are also available in a reversed (blowing in) air flow mode and with NEMA 3R / IP 55 protection class.





Exhaust filter

For a constant enclosure climate

FF 4000

- ✓ Low noise
- ✓ Standard enclosure cutouts (5 sizes)
- ✓ Tool free filter change
- ✓ Easy installation and maintenance

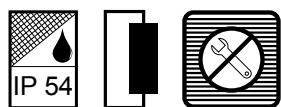

Model	FF 4000 000	FF 4000 100	FF 4000 200	FF 4000 300	FF 4000 400
Order number RAL 7035	400000000	400010000	400020000	400030000	400040000
Order number RAL 9005	400000003	400010003	400020003	400030003	400040003
Filter class EN 779	G3				
Operating temperature range	-10°C - 55°C				
Dimensions A x B x C (mm)	106.5 x 106.5 x 23.2	150 x 150 x 29.2	204 x 204 x 29.5	250 x 250 x 33.8	325 x 325 x 34
Cut out dimension (mm)	92.5 x 92.5 (+1.5)	124 x 124 (+1.5)	177 x 177 (+1.5)	223 x 223 (+1.5)	291 x 291 (+1.5)
Housing material	ABS plastic				
Weight	0.07 kg	0.18 kg	0.26 kg	0.42 kg	0.60 kg
Degree of separation	85% - DIN 24185				
Wall thickness	1 - 2 mm	1.3 - 3.2 mm	1.5 - 2.5 mm		
Installation	Elastic clips				
IP Ingress protection	IP 54, Type 12				
Certification	CE, cURus, cULus, CSA				
Order number G3 Filter	400000100	400010100	400010200	400010300	400010400

Protection hoods IP 56 / NEMA 4X for filter fans and exhaust filters on page 160



G3 Filter

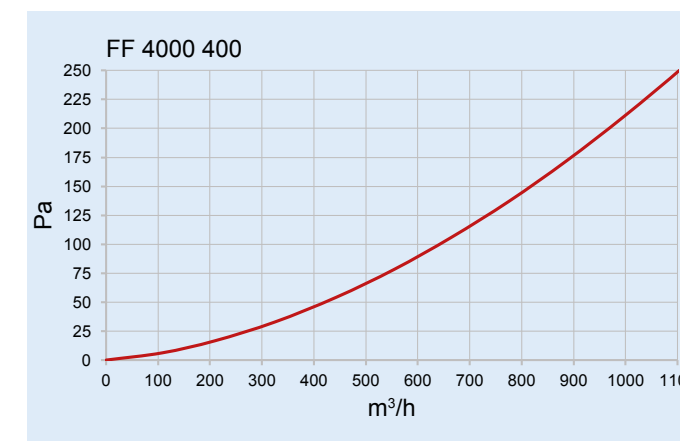
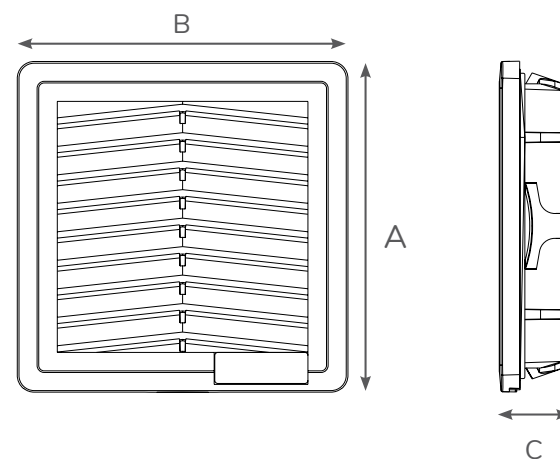
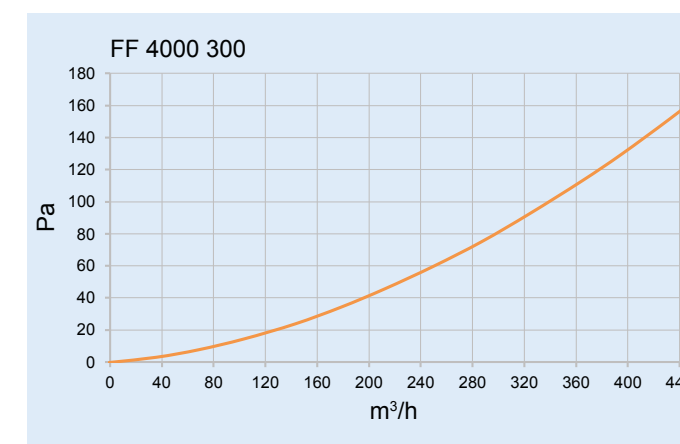
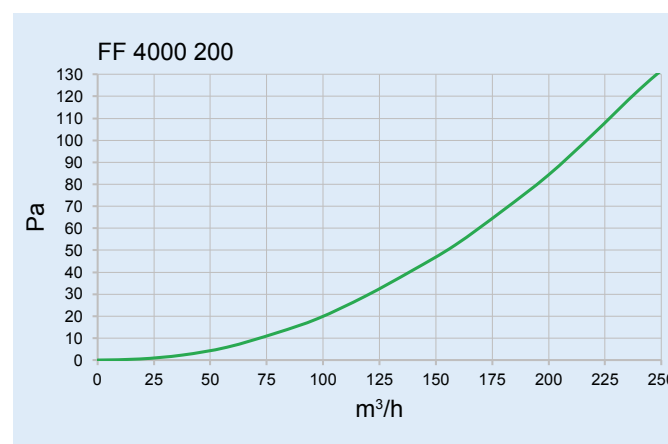
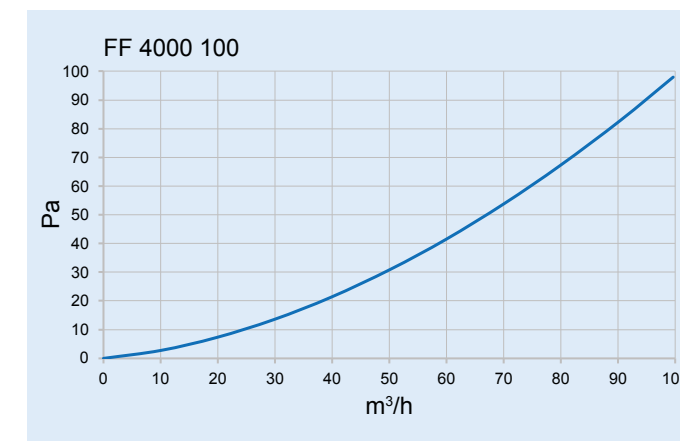
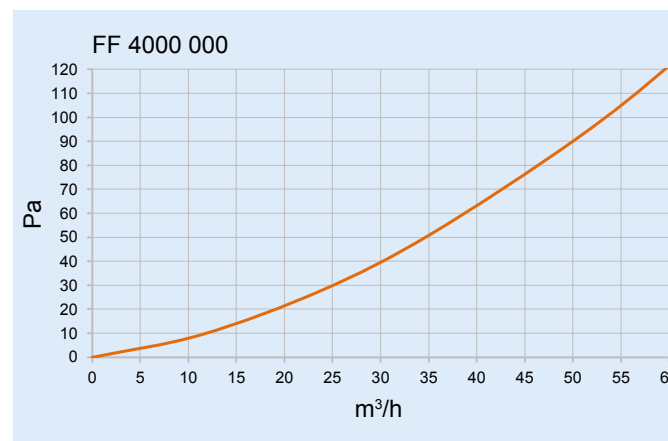



Filter fans

For a constant enclosure climate

FL 4010A - FL 4023A

- ✓ Tool free installation and filter change
- ✓ Standard enclosure cutouts (5 sizes)
- ✓ Prevent the formation of heat pockets in enclosures

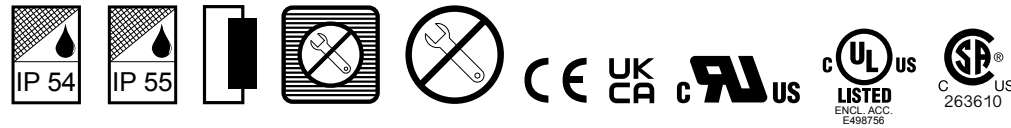

Model	FL 4010A				FL 4023A	
Order number RAL 7035	4010A4000	4010A4100 ¹⁾	4010A3000	4010A3100 ¹⁾	4023A4000	4023A3000
Order number RAL 9005	4010A4003	4010A4103 ¹⁾	4010A3003	4010A3103 ¹⁾	4023A4003	4023A3003
Order number Type 3R	4010A4033		4010A3033		4023A4033	4023A3033
Filter class EN 779	G3 (G4 for IP 55, Type 3R)					
Operating temperature range	-10°C - 55°C					
Unimpeded air flow	12 m³/h	16 - 21 m³/h	15 m³/h	21 m³/h	22 m³/h	26 m³/h
Static pressure ²⁾	23 / 33 Pa	45 / 64 Pa	33 Pa	64 Pa	41 / 57 Pa	57 Pa
Dimensions (A x B x C)	106.5 x 106.5 x 66.6 mm				106.5 x 106.5 x 79.5 mm	
Cutout dimensions	92.5 x 92.5 (+0.5) mm					
Housing material	PC-ABS (Type 3R - PPE+PS)					
Weight	0.39 kg				0.54 kg	
ELECTRICAL DATA						
Voltage / Frequency	230 V ~ 50/60 Hz		120 V ~ 60 Hz		230 V ~ 50/60 Hz	120 V ~ 60 Hz
Rated current ²⁾	0.06 / 0.05 A		0.09 A		0.08 / 0.07 A	0.13 A
Power consumption ²⁾	10 / 8 W		7 W	7.5 W	12 / 11 W	10 W
Degree of separation	85% - DIN 24185					
Wall thickness	1 - 2 mm					
Installation	Elastic clips					
Noise level ²⁾	31 / 33 dB(A)		33 dB(A)	37 / 42 dB(A)	42 dB(A)	
IP Ingress protection	IP 54, Type 12 / IP 55, Type 3R					
Certification	CE, cURus, cULus, CSA					

¹⁾ Reversed air flow

²⁾ Values for 50/60 Hz

Protection hoods IP 56 / NEMA 4X for filter fans and exhaust filters on page 160



G3 Filter 400000100



Thermostat 301120

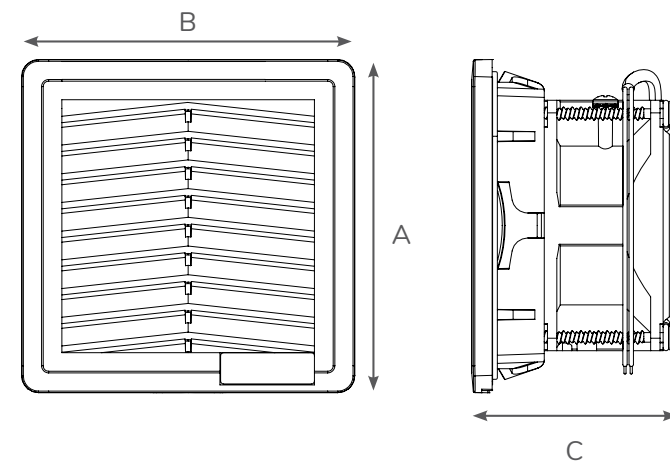
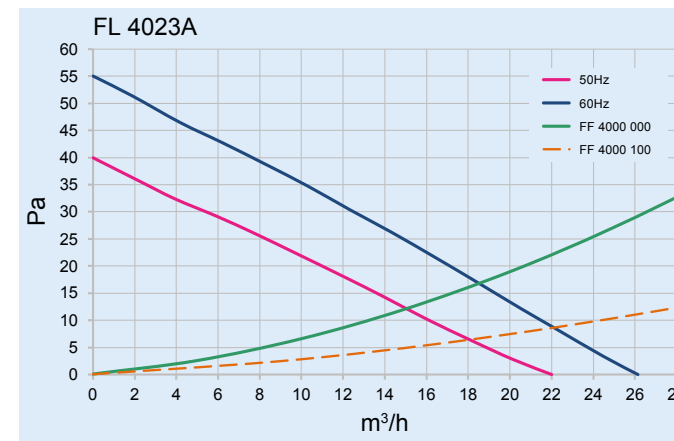
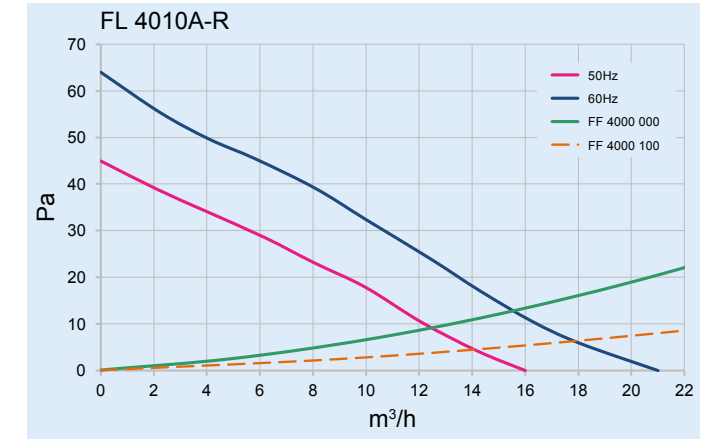
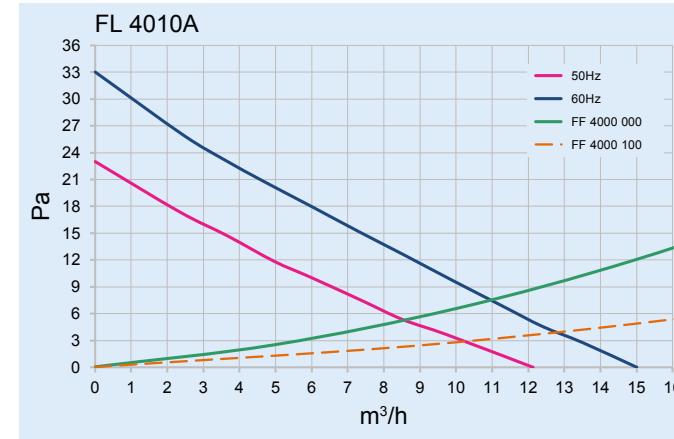



Filter fans

For a constant enclosure climate

FL 4210A - FL 4210D

- ✓ Tool free installation and filter change
- ✓ Standard enclosure cutouts (5 sizes)
- ✓ Prevent the formation of heat pockets inside enclosures

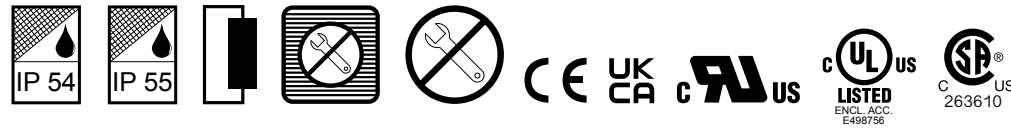

Model	FL 4210A				FL 4210D			
Order number RAL 7035	4210A4000	4210A4100 ¹⁾	4210A3000	4210A3100 ¹⁾	4210D2000	4210D4100 ¹⁾	4210D7000	4210D7100 ¹⁾
Order number RAL 9005	4210A4003	4210A4103 ¹⁾	4210A3003	4210A3103 ¹⁾	4210D2003	4210D4103 ¹⁾	4210D7003	4210D7103 ¹⁾
Order number Type 3R	4210A4033		4210A3033		4210D2033		4210D7033	
Filter class EN 779	G3 (G4 for IP 55, Type 3R)							
Operating temperature range	-10°C - 55°C							
Unimpeded air flow	67 m³/h	60 - 70 m³/h	67 - 79 m³/h	70 m³/h	47 m³/h	64 m³/h	47 m³/h	64 m³/h
Static pressure ²⁾	73 / 86 Pa	86 / 115 Pa	86 Pa	86 / 115 Pa	56 Pa	79 Pa	56 Pa	79 Pa
Dimensions (A x B x C)	150 x 150 x 73 mm							
Cutout dimensions	124 x 124 (+1.5) mm							
Housing material	PC-ABS (Type 3R - PPE+PS)							
Weight	0.8 kg				0.5 kg			
ELECTRICAL DATA								
Voltage / Frequency	230 V ~ 50/60 Hz		120 V ~ 60 Hz	120 V ~ 60 Hz	24 V DC		48 V DC	
Rated current ²⁾	0.13 / 0.10 A		0.22 A	0.25 / 0.22 A	0.31 A		0.18 A	
Power consumption ²⁾	18 / 16 W		17 W	19 / 17 W	7.4 W		8.6 W	
Degree of separation	85% - DIN 24185							
Wall thickness	1 - 2.1 mm							
Installation	Elastic clips							
Noise level ²⁾	40 / 44 dB(A)				48 dB(A)			
IP Ingress protection	IP 54, Type 12 / IP 55, Type 3R							
Certification	CE, cURus, cULus, CSA							

¹⁾ Reversed air flow

²⁾ Values for 50/60 Hz

Protection hoods IP 56 / NEMA 4X for filter fans and exhaust filters on page 160



G3 Filter 400010100



Thermostat 301120

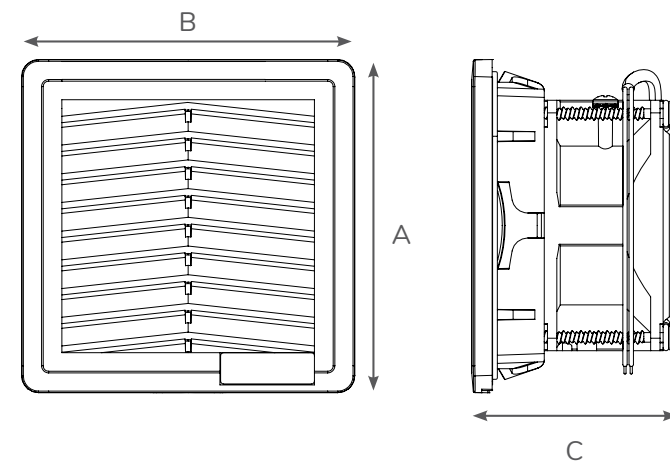
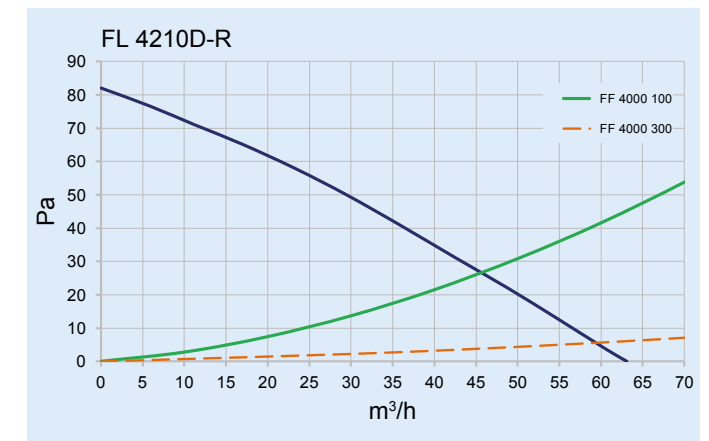
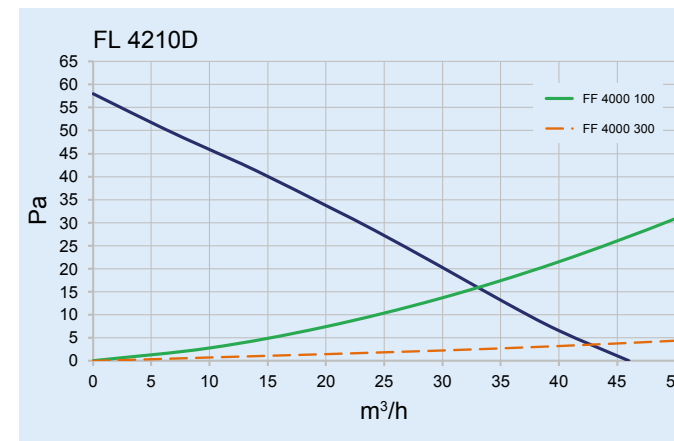
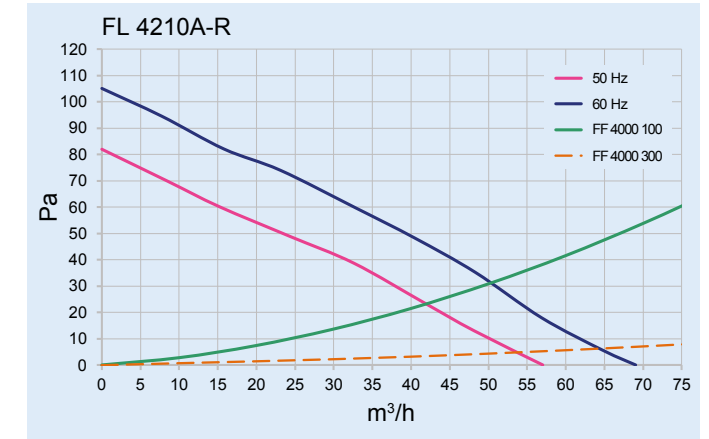
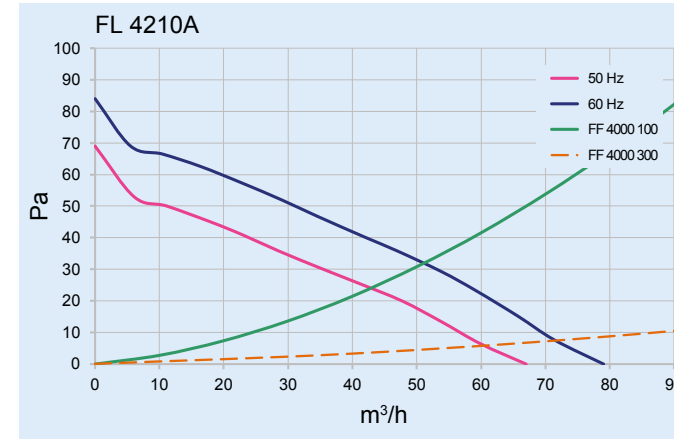



Filter fans

For a constant enclosure climate

FL 4411A - FL 4610D

- ✓ Tool free installation and filter change
- ✓ Standard enclosure cutouts (5 sizes)
- ✓ Prevent the formation of heat pockets inside enclosures



Model	FL 4411A				FL 4610D			
Order number RAL 7035	4411A4000	4411A4100 ¹⁾	4411A3000	4411A3100 ¹⁾	4610D2000	4610D2100 ¹⁾	4610D7000	4610D7100 ¹⁾
Order number RAL 9005	4411A4003	4411A4103 ¹⁾	4411A3003	4411A3103 ¹⁾	4610D2003	4610D2103 ¹⁾	4610D7003	4610D7103 ¹⁾
Order number Type 3R	4411A4033		4411A3033					
Filter class EN 779	G3 (G4 for IP 55, Type 3R)							
Operating temperature range	-10°C - 55°C							
Unimpeded air flow	110 m³/h	110 - 135 m³/h	130 m³/h	135 m³/h	225 m³/h	225 m³/h	225 m³/h	225 m³/h
Static pressure ²⁾	80 / 100 Pa	100 / 120 Pa	100 Pa	120 Pa	99 Pa	140 Pa	99 Pa	140 Pa
Dimensions (A x B x C)	204 x 204 x 95.5 mm				250 x 250 x 124.2 mm			
Cutout dimensions	177 x 177 (+1.5) mm				223 x 223 (+1.5) mm			
Housing material	PC-ABS (Type 3R - PPE+PS)							
Weight	1.2 kg				1.4 kg			
ELECTRICAL DATA								
Voltage / Frequency	230 V ~ 50/60 Hz		120 V ~ 60 Hz		24 V DC		48 V DC	
Rated current ²⁾	0.13 / 0.11 A		0.18 A	0.22 A	0.71 A	0.71 A	0.34 A	0.34 A
Power consumption ²⁾	19 / 17 W	19 / 18 W	15 W	18 W	17 W	17 W	16 W	16 W
Degree of separation	85% - DIN 24185							
Wall thickness	1 - 2.1 mm							
Installation	Elastic clips							
Noise level ²⁾	40 / 44 dB(A)		44 dB(A)		58 dB(A)		60 dB(A)	
IP Ingress protection	IP 54, Type 12 / IP 55, Type 3R							
Certification	CE, cURus, cULus, CSA							

¹⁾ Reversed air flow

²⁾ Values for 50/60 Hz

Protection hoods IP 56 / NEMA 4X for filter fans and exhaust filters on page 160



G3 Filter 400010200



Thermostat 301120



G3 Filter 400010300

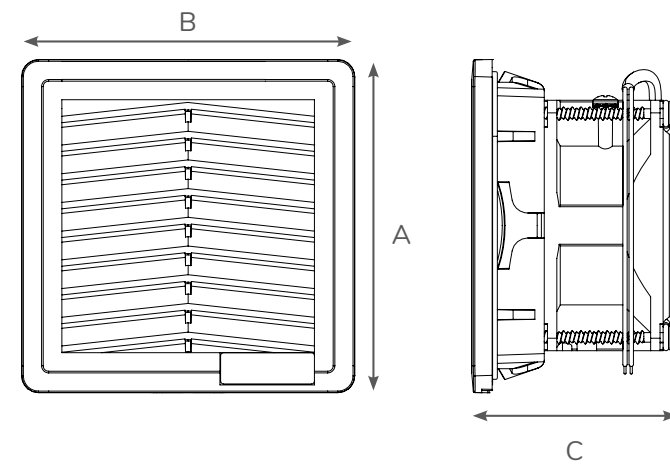
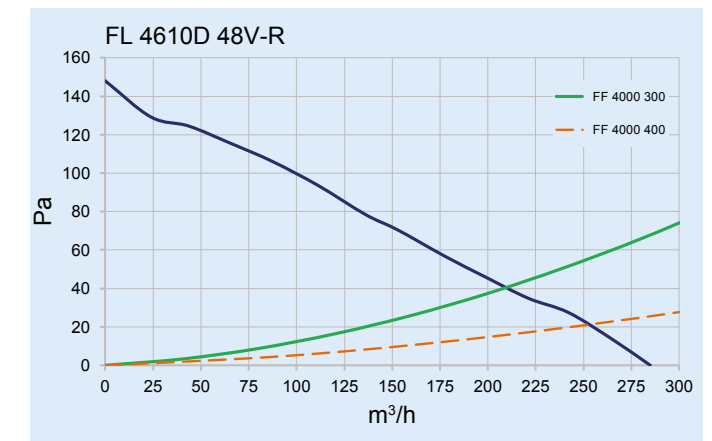
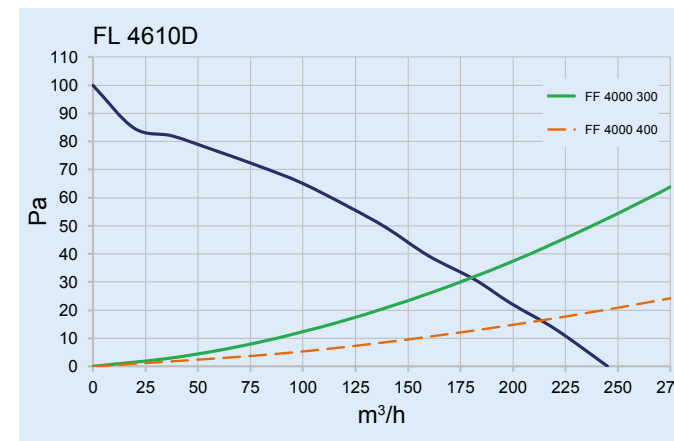
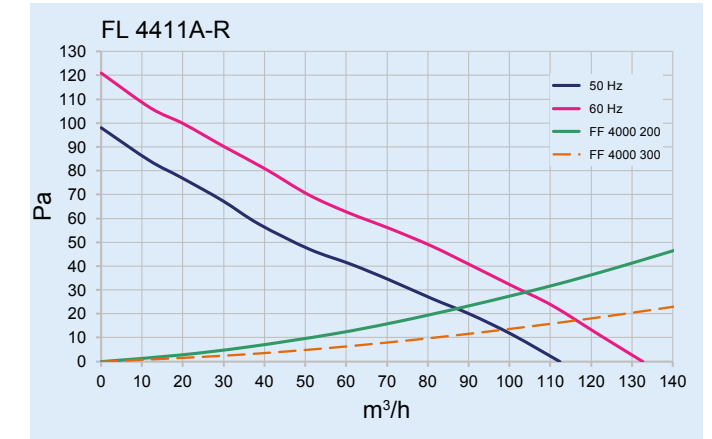
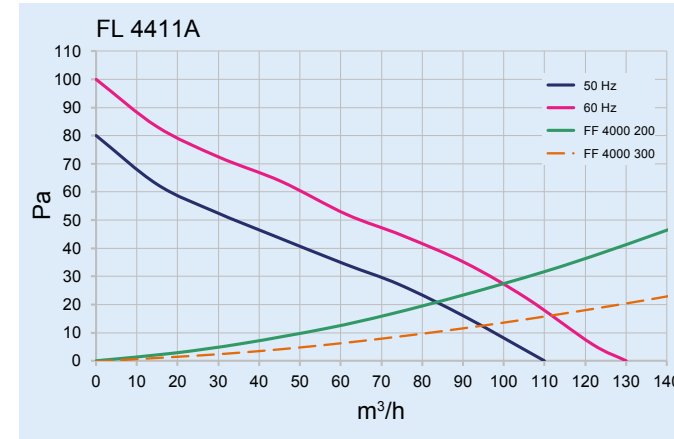



Filter fans

For a constant enclosure climate

FL 4620A - FL 4621A

- ✓ Tool free installation and filter change
- ✓ Standard enclosure cutouts (5 sizes)
- ✓ Prevent the formation of heat pockets inside enclosures

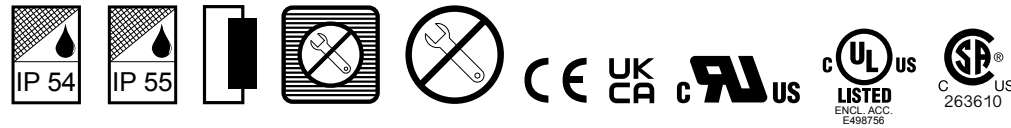

Model	FL 4620A				FL 4621A			
Order number RAL 7035	4620A4000	4620A4100 ¹⁾	4620A3000	4620A3100 ¹⁾	4621A4000	4621A4100 ¹⁾	4621A3000	4621A3100 ¹⁾
Order number RAL 9005	4620A4003	4620A4103 ¹⁾	4620A3003	4620A3103 ¹⁾	4621A4003	4621A4103 ¹⁾	4621A3003	4621A3103 ¹⁾
Order number Type 3R	4620A4033		4620A3033		4621A4033		4621A3033	
Filter class EN 779	G3 (G4 for IP 55, Type 3R)							
Operating temperature range	-10°C - 55°C							
Unimpeded air flow	230 m³/h	245 - 290 m³/h	270 m³/h	290 m³/h	105 m³/h	110 - 120 m³/h	120 m³/h	
Static pressure ²⁾	115 / 155 Pa	165 / 210 Pa	155 Pa	210 Pa	54 / 57 Pa	66 / 70 Pa	57 Pa	70 Pa
Dimensions (A x B x C)	250 x 250 x 124.2 mm				250 x 250 x 111.8 mm			
Cutout dimensions	223 x 223 (+1.5) mm							
Housing material	PC-ABS (Type 3R - PPE+PS)							
Weight	1.5 kg				1.2 kg			
ELECTRICAL DATA								
Voltage / Frequency	230 V ~ 50/60 Hz		120 V ~ 60 Hz		230 V ~ 50/60 Hz		120 V ~ 60 Hz	
Rated current ²⁾	0.135 / 0.16 A		0.27 A	0.26 A	0.11 / 0.10 A		0.21 A	
Power consumption ²⁾	32 / 36 W		31 W		18 / 17 W		16 W	
Degree of separation	85% - DIN 24185							
Wall thickness	1.5 - 2.5 mm							
Installation	Elastic clips							
Noise level ²⁾	50 / 55 dB(A)		55 dB(A)		48 / 54 dB(A)		49 dB(A)	
IP Ingress protection	IP 54, Type 12 / IP 55, Type 3R							
Certification	CE, cURus, cULus, CSA							

¹⁾ Reversed air flow

²⁾ Values for 50/60 Hz

Protection hoods IP 56 / NEMA 4X for filter fans and exhaust filters on page 160



G3 Filter 400010300



Thermostat 301120

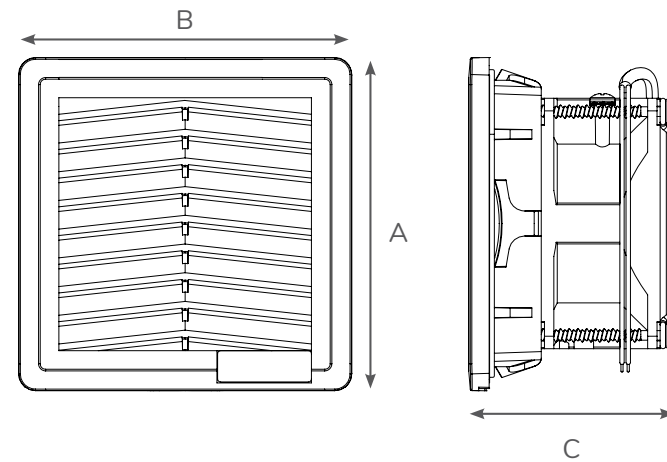
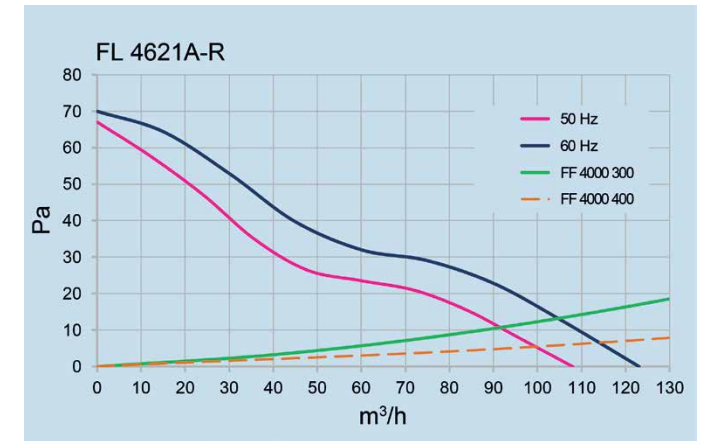
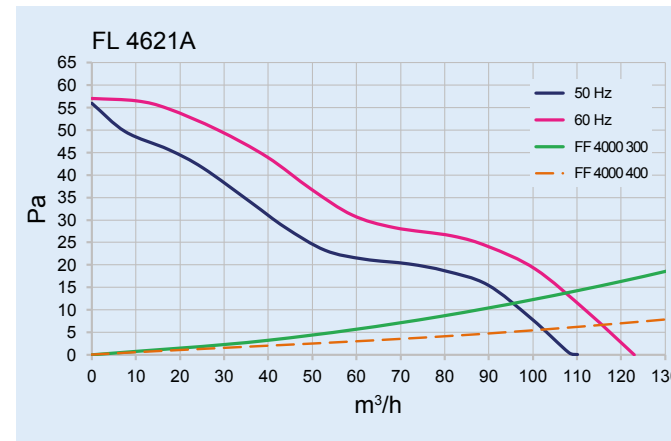
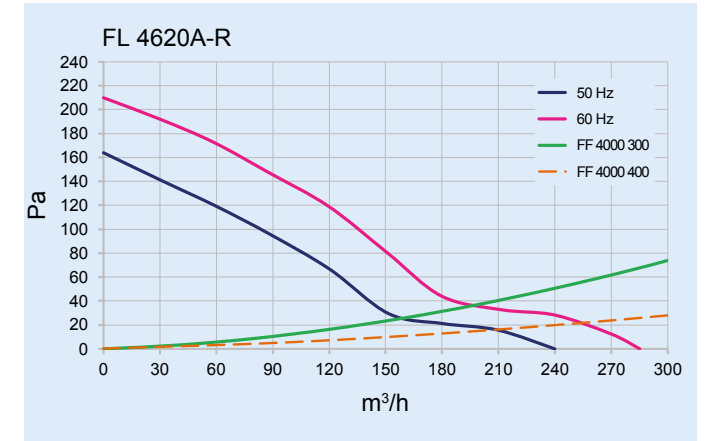
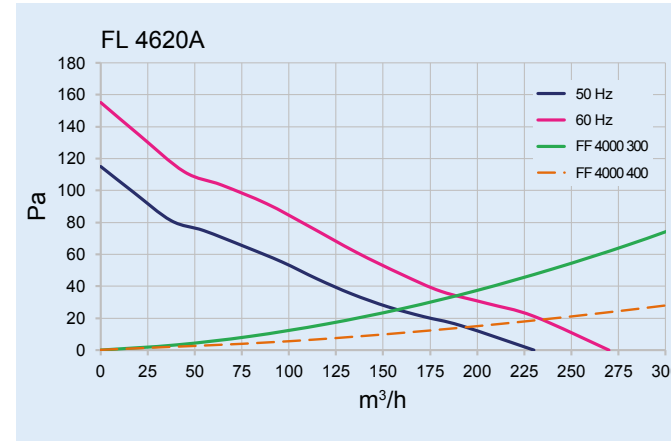



Filter fans

For a constant enclosure climate

FL 4830A - FL 4883A

- ✓ Tool free installation and filter change
- ✓ Standard enclosure cutouts (5 sizes)
- ✓ Prevent the formation of heat pockets inside enclosures

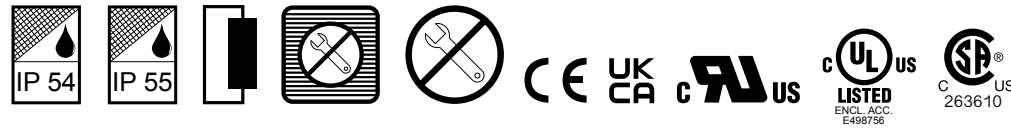

Model	FL 4830					FL 4883A									
Order number RAL 7035	4830A4000	4830A4100 ¹⁾	4830A3000	4830A3100 ¹⁾	4830A9000	4883A4000	4883A4100 ¹⁾	4883A3000	4883A3100 ¹⁾	4883A9000					
Order number RAL 9005	4830A4003	4830A4103 ¹⁾	4830A3003	4830A3103 ¹⁾	4830A9003	4883A4003	4883A4103 ¹⁾	4883A3003	4883A3103 ¹⁾	4883A9003					
Order number Type 3R	4830A4033		4830A3033												
Filter class EN 779	G3 (G4 for IP 55, Type 3R)					G3									
Operating temp. range	-10°C - 55°C					-10°C - 70°C									
Unimpeded air flow	455 m³/h	540 m³/h	485 m³/h	575 m³/h	540 m³/h	820 m³/h	930 m³/h	820 m³/h							
Static pressure ²⁾	134 / 146 Pa	207 / 221 Pa	190 Pa	207 Pa	180 Pa	214 / 219 Pa									
Dimensions (A x B x C)	325 x 325 x 160.2 mm					325 x 325 x 158.5 mm									
Cutout dimensions	291 x 291 (+1.5) mm														
Housing material	PC-ABS (Type 3R - PPE+PS)														
Weight	3.6 kg					3.1 kg					4.25 kg				
ELECTRICAL DATA															
Voltage / Frequency	230 V ~ 50/60 Hz		120 V ~ 60 Hz		380-415V 50 Hz 3~ 400-460V 60 Hz 3~		230 V ~ 50/60 Hz		120 V ~ 60 Hz		400 / 460 V ~ 50/60 Hz				
Rated current ²⁾	0.31 / 0.35 A		0.73 A		0.25 A		0.20 / 0.24 A		0.24 A		1.5 A	0.2 / 0.24 A			
Power consumption ²⁾	70 / 85 W		83 W		169 W		125 / 166 W		172 W		172 W	110 / 145 W			
Degree of separation	85% - DIN 24185														
Wall thickness	1.5 - 2.5 mm														
Installation	Elastic clips														
Noise level ²⁾	65.3 / 68.1 dB(A)		69.2 dB(A)		69.8 / 72.7 dB(A)		66 / 69.2 dB(A)								
IP Ingress protection	IP 54, Type 12 / IP 55, Type 3R					IP 54, Type 12									
Certification	CE, cURus, cULus, CSA					CE, cURus, cULus									

¹⁾ Reversed air flow

²⁾ Values for 50/60 Hz

Protection hoods IP 56 / NEMA 4X for filter fans and exhaust filters on page 160



G3 Filter 400010400



Thermostat 301120

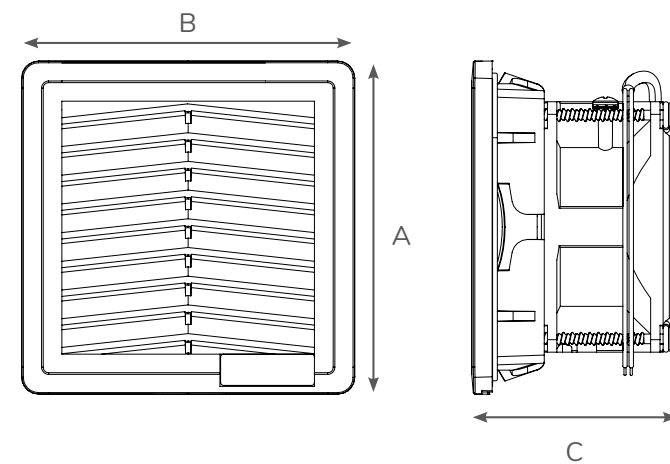
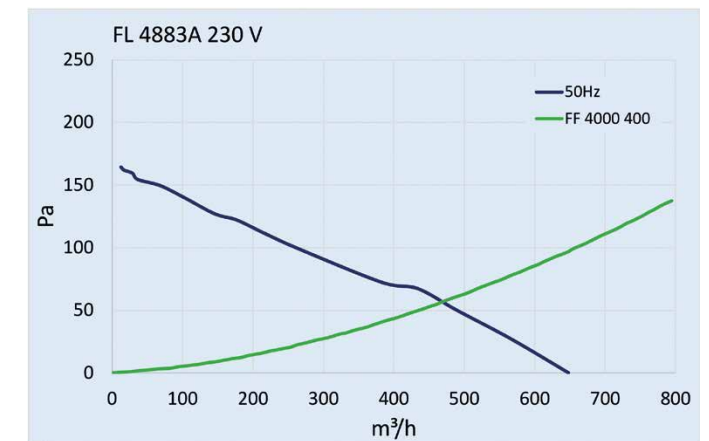
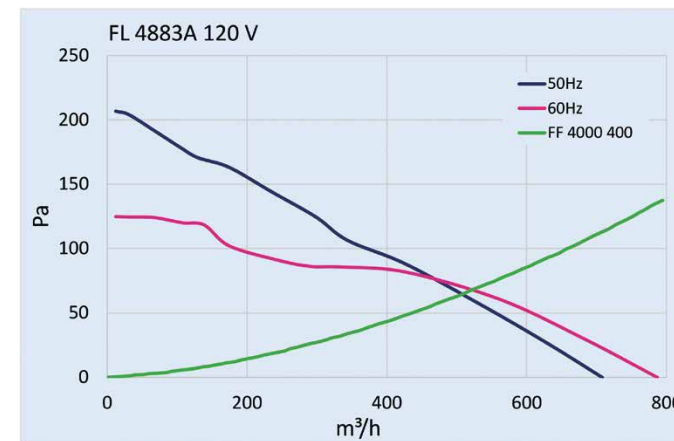
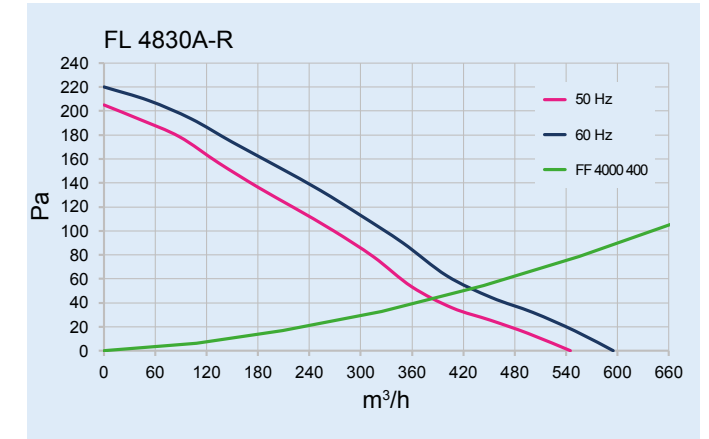
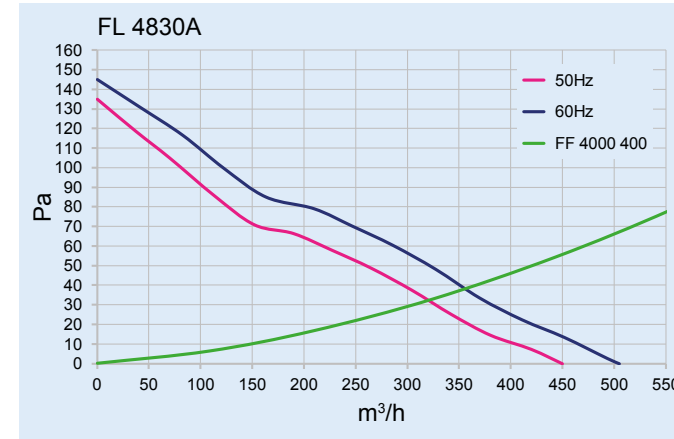

Roof mounted filter fans / exhaust filter

If there is no other space available



FF 6000 - FL 6064A - FL 6065A

- ✓ One cutout for five different air flow volumes
- ✓ Easy installation, filter included
- ✓ Low installation depth
- ✓ Various clip options for thermostats
- ✓ Robust mild steel construction, powder coated
- ✓ Fast & easy maintenance outside the enclosure

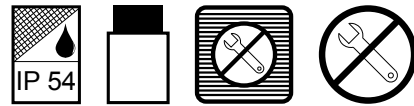

Model	Exhaust filter FF 6000	FL 6064A			FL 6065A		
Order number	600000000	6064A4000	6064A3000	6064D2000	6065A4000	6065A3000	6065A9000
Filter class EN 779	G3	G3 (aluminium filter optional)					
Operating temperature range	-10°C - 55°C	-10°C - 55°C					
Unimpeded air flow	-	275 m³/h		310 m³/h	490 m³/h		
Static pressure ²⁾	-	65 Pa	61 Pa	78 Pa	360 Pa	450 Pa	350 Pa
Dimensions (A x B x C)	147 x 457 x 457 mm	147 x 457 x 457 mm					
Cutout dimensions	291 x 291 mm	291 x 291 mm					
Housing material / colour	ABS plastic	Mild steel powder coated, RAL 7035					
Weight	0,2 kg	7 kg		6.1 kg	6.4 kg	6.1 kg	6.4 kg
ELECTRICAL DATA							
Voltage / Frequency	-	230 V ~ 50/60 Hz	120 V ~ 60 Hz	24 V DC	230 V ~ 50/60 Hz	120 V ~ 60 Hz	400 / 460 V - 50/60 Hz 3~
Rated current ²⁾	-	0.30 A	0.5 A	1 A	0.26 / 0.35 A	0.61 A	0.13 / 0.17 A
Power consumption ²⁾	-	68 W	57 W	24 W	58 / 80 W	70 W	50 / 80 W
Degree of separation	85% - DIN 24185	85% - DIN 24185					
Wall thickness	1,5 - 3,5 mm	1.5 - 3.5 mm					
Installation	-	4 - pole Pushfit connector					
Noise level ²⁾	-	51 dB(A)			70 dB(A)		
IP Ingress protection	IP 54, Type 12, 3R	IP 54, Type 12					
Certification	CE, cURus	CE, cURus, cULus					

²⁾ Values for 50/60 Hz



AC-60XX-BF-1 Washable aluminium filter, 4 pcs.



AC-60XX-O-1 Fibre filter G3, 4 pcs.



Thermostat 301120

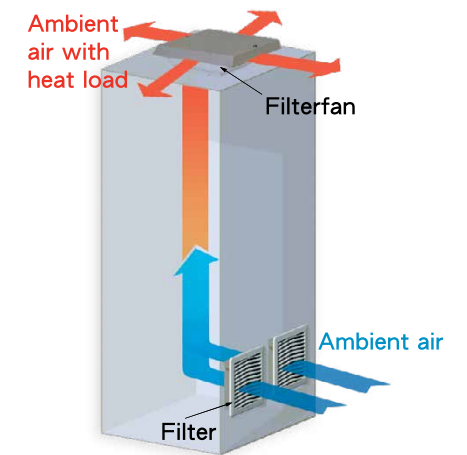
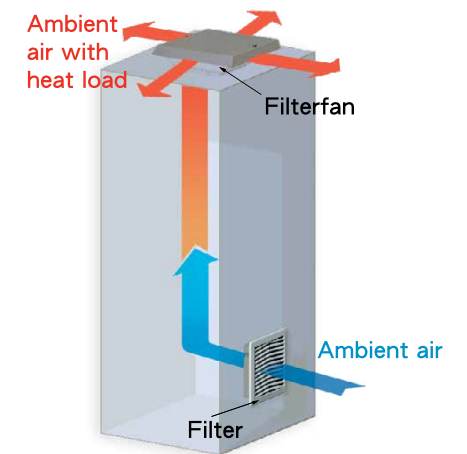
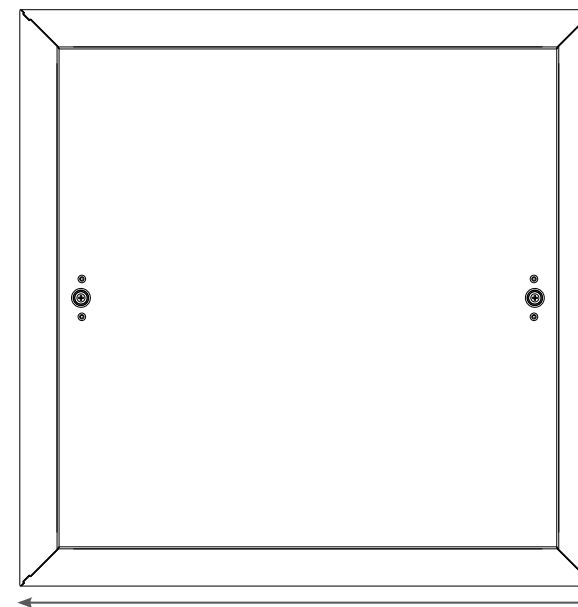
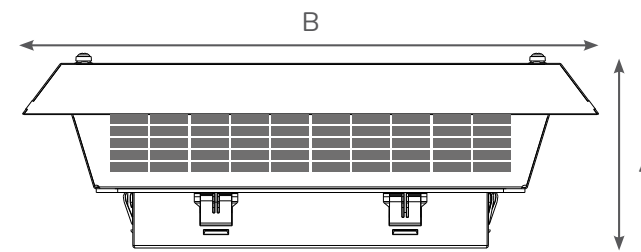
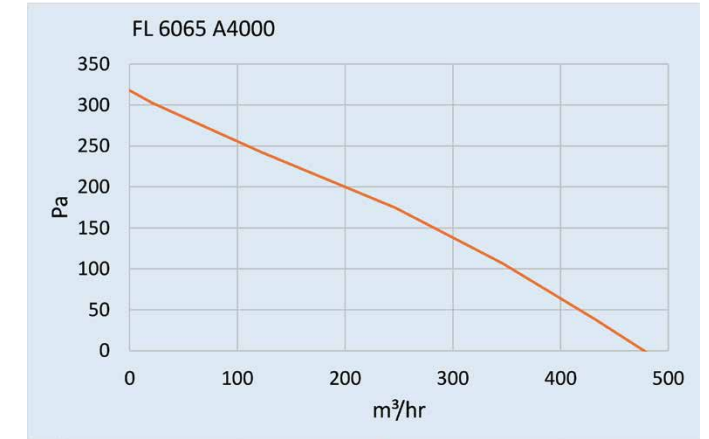
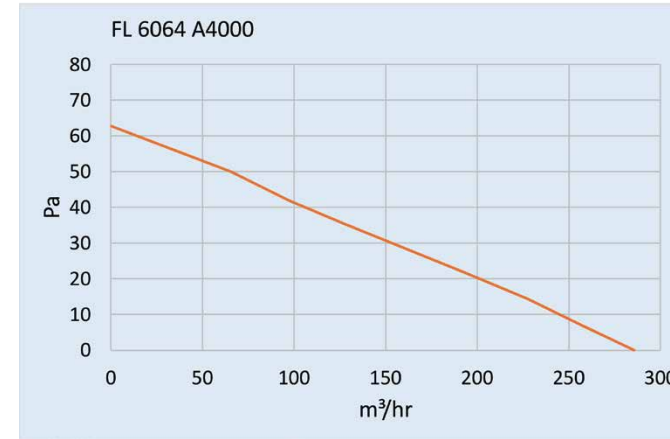

Roof mounted filter fans

If there is no other space available



FL 6085A - FL 6095A

- ✓ One cutout for five different air flow volumes
- ✓ Easy installation, filter included
- ✓ Low installation depth
- ✓ Various clip options for thermostats
- ✓ Robust mild steel construction, powder coated
- ✓ Fast & easy maintenance outside the enclosure

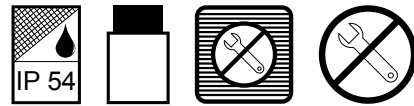

Model	FL 6085A			FL 6095A		
Order number	6085A4000	6085A3000	6085A9000	6095A4000	6095A3000	6095A9000
Filter class EN 779	G3 (aluminium filter optional)					
Operating temperature range	-10°C - 55°C					
Unimpeded air flow	630 m³/h			970 m³/h		
Static pressure ²⁾	360 Pa	470 Pa	570 Pa	750 Pa	550 Pa	
Dimensions (A x B x C)	147 x 457 x 457 mm					
Cutout dimensions	291 x 291 mm					
Housing material / colour	Mild steel powder coated, RAL 7035					
Weight	6.4 kg			7 kg		
ELECTRICAL DATA						
Voltage / Frequency	230 V ~ 50/60 Hz	120 V ~ 60 Hz	400 / 460 V - 50/60 Hz 3~	230 V ~ 50/60 Hz	120 V ~ 60 Hz	400 / 460 V - 50/60 Hz 3~
Rated current ²⁾	0.38 / 0.50 A	0.88 A	0.25 / 0.32 A	0.7 / 1.0 A	1.88 A	0.38 / 0.50 A
Power consumption ²⁾	8 / 116 W	108 W	98 / 145 W	160 / 229 W	225 W	150 / 230 W
Degree of separation	85% - DIN 24185					
Wall thickness	1.5 - 3.5 mm					
Installation	4 - pole Pushfit connector					
Noise level ²⁾	70 dB(A)			76 dB(A)		
IP Ingress protection	IP 54, Type 12					
Certification	CE, cURus, cULus					

¹⁾ Values for 50/60 Hz



AC-60XX-BF-1 Washable aluminium filter, 4 pcs.



AC-60XX-O-1 Fibre filter G3, 4 pcs.



Thermostat 301120

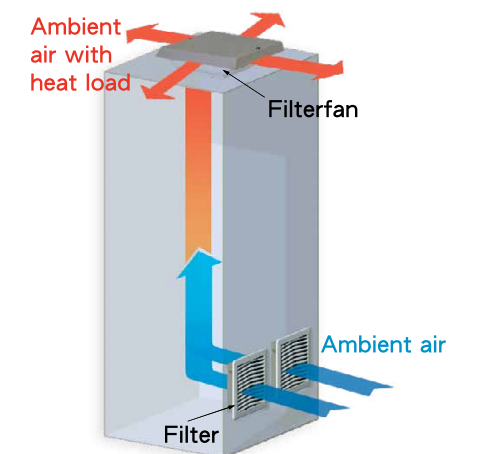
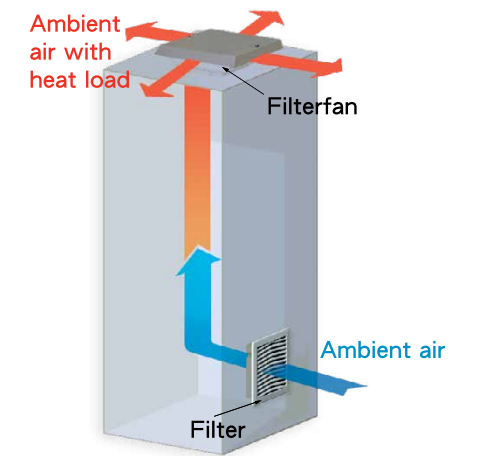
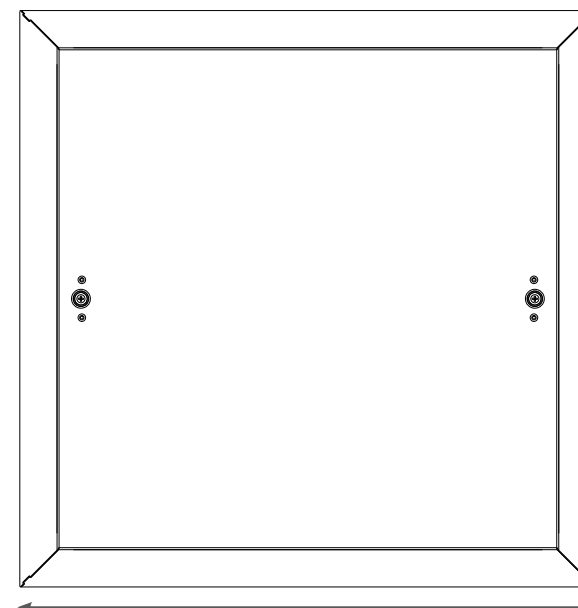
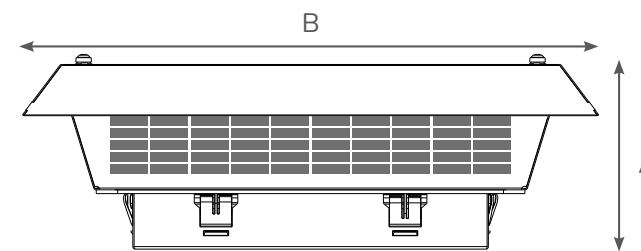
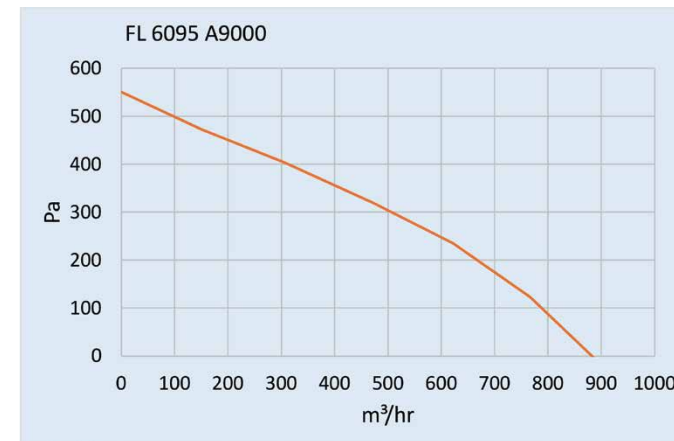
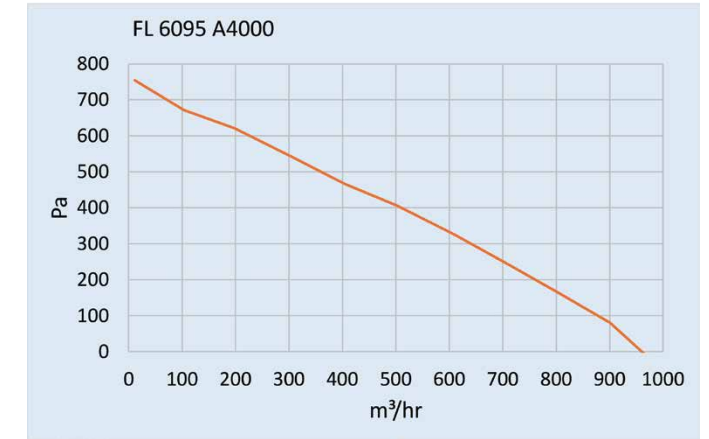
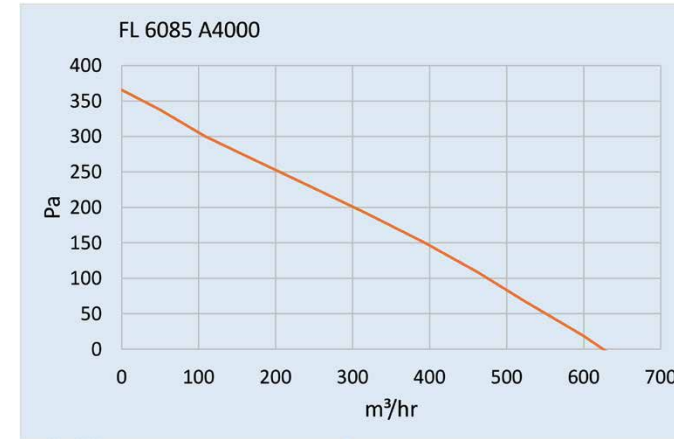

Roof mounted filter fans

If there is no other space available



FL 6995A - FL 6996A

- ✓ One cutout for five different air flow volumes
- ✓ Easy installation, filter included
- ✓ Low installation depth
- ✓ Various clip options for thermostats
- ✓ Robust mild steel construction, powder coated
- ✓ Fast & easy maintenance outside the enclosure
- ✓ Low-noise, suitable for offices and data centers (FL 6996A)

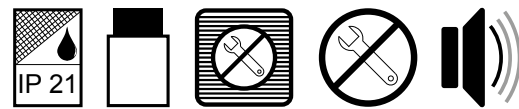

Model	FL 6995A			FL 6996A
Order number	6995A4000	6995A3000	6995A9000	6996A4000
Filter class EN 779	Aluminium filter			
Operating temperature range	-10°C - 50°C			-10°C - 55°C
Unimpeded air flow	1400 m ³ /h			1500 m ³ /h
Static pressure ²⁾	680 Pa	850 Pa	660 Pa	75 Pa
Dimensions (A x B x C)	147 x 457 x 457 mm			241 x 550 x 550 mm
Cutout dimensions	291 x 291 mm			410 x 410 mm
Housing material / colour	Mild steel powder coated, RAL 7035			
Weight	7.8 kg		8.3 kg	7 kg
ELECTRICAL DATA				
Voltage / Frequency	230 V ~ 50/60 Hz	120 V ~ 60 Hz	400 / 460 V - 50/60 Hz 3~	230 V ~ 50/60 Hz
Rated current ²⁾	0.96 / 1.51 A	2.67 A	0.58 / 0.80 A	0.29 / 0.35 A
Power consumption ²⁾	220 / 348 W	320 W	230 / 370 W	65 / 80 W
Degree of separation	85% - DIN 24185			
Wall thickness	1.5 - 3.5 mm			
Installation	4 - pole Pushfit connector			
Noise level ²⁾	82 dB(A)			55 dB(A)
IP Ingress protection	IP 21, Type 1			
Certification	CE			

²⁾ Values for 50/60 Hz



AC-60XX-BF-1 Washable aluminium filter, 4 pcs.
AC-69XX-BF-1 Washable aluminium filter, 4 pcs.



AC-60XX-O-1 Fibre filter G3, 4 pcs.
AC-69XX-O-1 Fibre filter G3, 4 pcs.



Thermostat 301120

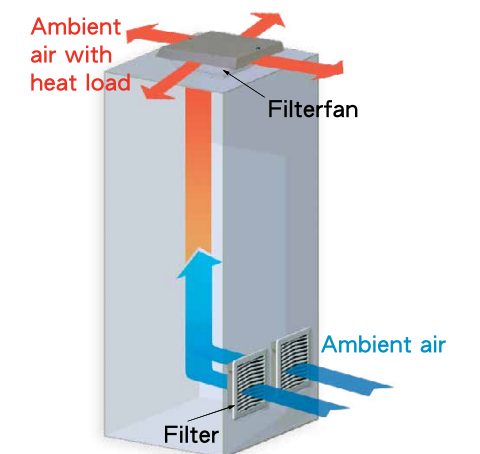
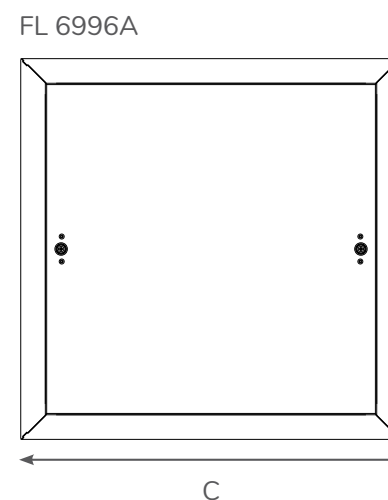
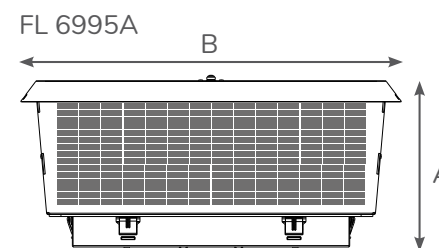
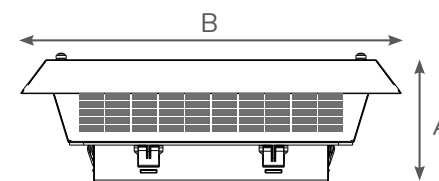
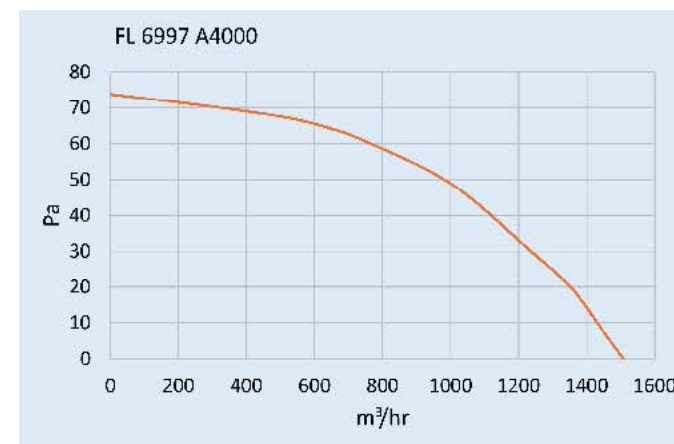
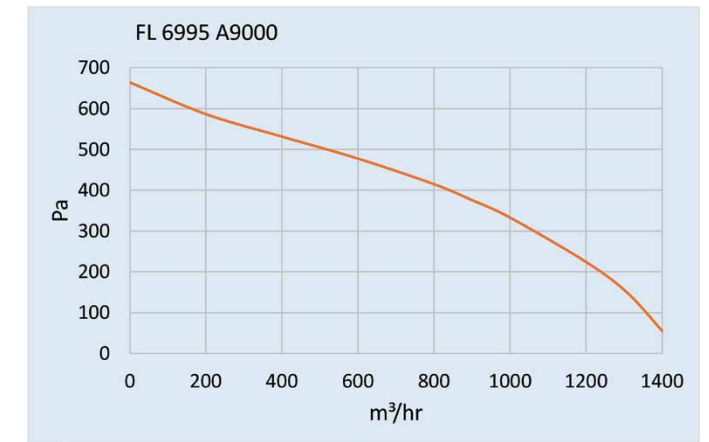
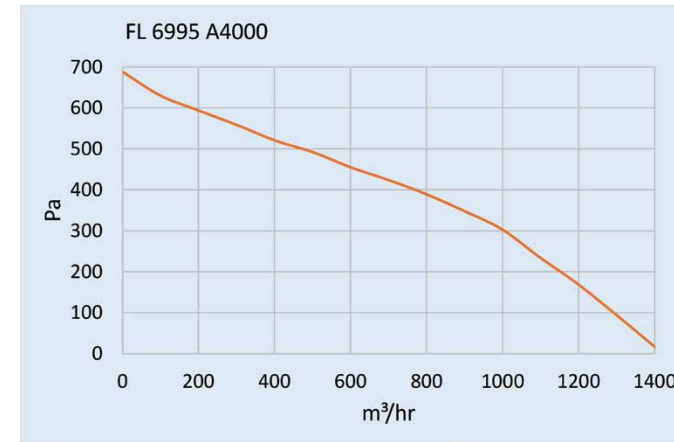



Protection hood

Enhanced protection for filter fans and exhaust filters

FC 4000

- ✓ Protection against water jets
- ✓ UL certified in combination with Seifert filter fans and exhaust filters
- ✓ Models with food safe gasket (blue)
- ✓ Stainless steel version complies to UL Type 4X
- ✓ Screwless mounting and removal of the hood
- ✓ Easy to clean

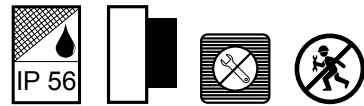

Model	FC 4000 with food safe gasket				
Order number	4000000020	4000100020	4000200020	4000300020	4000400020
Suitable for filter fan / exhaust filter size	106.5 x 106.5 mm	150 x 150 mm	204 x 204 mm	250 x 250 mm	325 x 325 mm
Housing material / gasket colour	Stainless steel AISI 304 (V2A) / blue				
Dimensions (H x W x D)	230 x 150 x 40 mm	245.5 x 176 x 55 mm	330 x 233 x 55 mm	390 x 282 x 85 mm	480 x 350 x 110 mm
Weight	0.65 kg	0.8 kg	1.2 kg	1.7 kg	2.5 kg
Installation	Mounting screws torque: 4.5 Nm				
Protection classes ¹⁾	IP 56 / Type 1, 2, 3, 3X, 3R, 3RX, 3S, 3SX, 4, 4X, 5, 12, 12K, 13				
Certification	CE, cULus, cURus				

¹⁾ When installed according to instruction manual

Model	FC 4000 with standard Silicon gasket				
Order number	4000000200	4000100200	4000200200	4000300200	4000400200
Order number stainless steel AISI 304 (V2A)	4000000220	4000100220	4000200220	4000300220	4000400220
Suitable for filter fan / exhaust filter size	106.5 x 106.5 mm	150 x 150 mm	204 x 204 mm	250 x 250 mm	325 x 325 mm
Housing material / gasket colour	Mild steel powder coated / RAL 7035 / white				
Dimensions (H x W x D)	230 x 150 x 40 mm	245.5 x 176 x 55 mm	330 x 233 x 55 mm	390 x 282 x 85 mm	480 x 350 x 110 mm
Weight	0.65 kg	0.8 kg	1.2 kg	1.7 kg	2.5 kg
Installation	Mounting screws torque: 4.5 Nm				
Protection classes ¹⁾	IP 56 / Type 1, 2, 3, 3R, 3S, 4, 5, 12, 12K, 13				
Certification	CE, cULus, cURus				

¹⁾ When installed according to instruction manual

Stainless steel version

With food safe gasket

- ✓ Increased protection to UL Type 4X
- ✓ Silicon gasket with high consistency suitable for the food industry
- ✓ Simple wall mounting
- ✓ Easily accessible filters simplify replacement
- ✓ Protects filter fans and exhaust filters from wind driven rain and water jets
- ✓ Impact resistant and robust
- ✓ Easy to clean



Mild steel, powder coated version

With standard Silicon gasket

- ✓ Increased protection to UL Type 4
- ✓ Standard Silicon gasket
- ✓ Simple wall mounting
- ✓ Easily accessible filters simplify replacement
- ✓ Protects filter fans and exhaust filters from wind driven rain and water jets
- ✓ Impact resistant and robust
- ✓ Easy to clean



UL TYPE 4X

UL TYPE 4



AVOIDING HUMIDITY AND CONDENSATION IN ENCLOSURES AND CABINETS

SOLIFLEX enclosure heaters



HEAT MANAGEMENT FOR THE ENCLOSURE

Temperature differences in enclosures, mostly in outdoor applications, often result in humidity and condensation which may cause malfunctions and corrosion. The use of the appropriate heating unit will eliminate these problems.

SOLIFLEX fan heaters have a small and compact design, they heat up dynamically and are very quiet in operation. The internal warm air is equally distributed throughout the enclosure.

A major advantage of fan heaters compared to PTC heaters is the much lower starting current. PTC heaters are compact in size, have a wider voltage range and the heating power adjusts in relation to the ambient temperature, resulting in better efficiency.



Enclosure heaters

PTC heater with fan

KH 401

- ✓ Small and compact design
- ✓ Low noise
- ✓ Dynamic heating
- ✓ Energy efficient
- ✓ Various mounting options



Model	KH 401
Order number	401350DCA7C000
Heating power at 10°C	350 W
Operating temperature range	-40°C - 70°C
Fan air flow approx.	17 m³/h
Mounting	Screw and DIN rail clips for G-rail (EN 50035) DIN rail clips 35 mm (EN 50022), DIN rail clips 15 mm (EN 50045)
Dimensions (H x W x D)	79 x 54 x 92 mm
Housing material / colour	PPS / PA66 plastic, black
Weight	150 g
ELECTRICAL DATA	
Voltage / Frequency	100 - 240 V ~ 60 / 60 Hz, Fan 24 V DC, 1.6 W
Rated current ¹⁾	3.0 / 1.6 A Fan 0.13 A
Fuse rating	4 A (T)
Connection	Heater cable 360 mm / fan cable 260 mm
IP protection class	IP 20
Certification	CE, cURus

¹⁾ Values for 120 / 230 V

Accessory: AC / DC power supply, order no. 409005, 0°C - 55 °C, 60 x 39 x 38.9 mm, IN: 85-264 V AC / 100-300 V DC OUT: 24 V DC / 5 W max.

Adjustable thermostat (NC) order no. 301110 on page 173

The delivery includes the DIN rail clips and screws listed below.



DIN rail clip for:



DIN rail 15mm



DIN rail 35mm



G - rail



Side screw connection



Screw fastening from the back



Power supply 409005

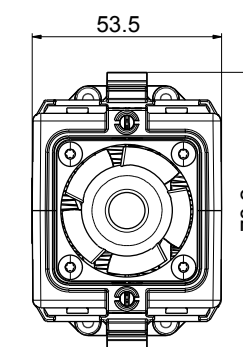
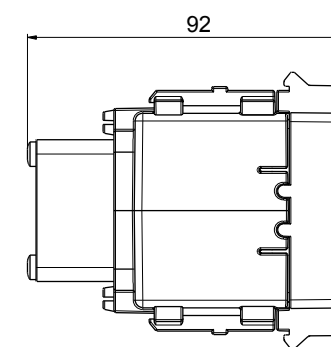
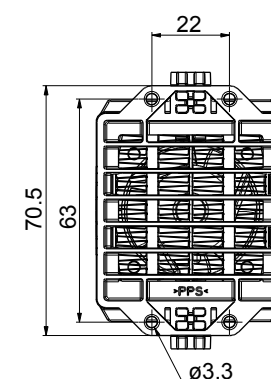



Enclosure heaters

PTC heater

KH 501

- ✓ Wide voltage range
- ✓ Dynamic heating through PTC technology
- ✓ With contact protection
- ✓ Energy efficient and environmentally friendly
- ✓ Compact size for small enclosures

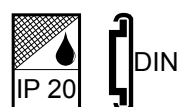

Model	KH 501				
Order number	501025	501050	501075	501100	501150
Heating power at 10°C	25 W	50 W	75 W	100 W	150 W
Operating temperature range	-45°C - 70°C				
Mounting	DIN rail				
Dimensions (H x W x D)	125 x 41 x 41 mm		140 x 70 x 63 mm		220 x 59 x 61 mm
Housing material / colour	PC plastic, black				
Weight	160 g		390 g		660 g
ELECTRICAL DATA					
Voltage / Frequency	110 - 240 V AC / DC				
Max current	2.5 A	3.5 A	4 A	5 A	9.5 A
Connection	2 screw terminal block for standard or rigid wire 2.5 mm ²				
IP protection class	IP 20				
Certification	CE, cURus				

Note: PTC resistor self-regulating

Adjustable thermostat (NC) order no. 301110 on page 173

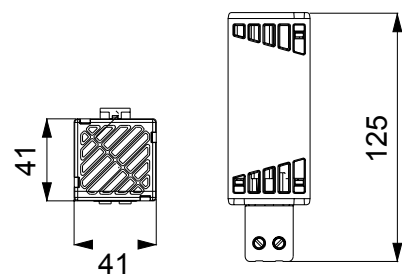

KH 501 25 - 50 W

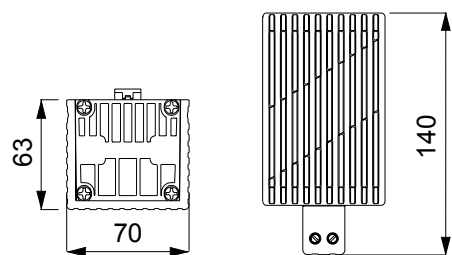

KH 501 75 - 100 W

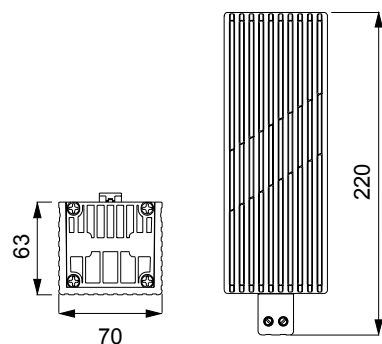

KH 501 150 W



Enclosure heaters

PTC heater with fan

KH 503

- ✓ Dynamic heating through PTC technology
- ✓ Energy efficient and environmentally friendly
- ✓ Compact design
- ✓ Low noise



Model	KH 503							
Order number	503250	503251	503400	503401	503500	503501	503750	503751
Heating power at 10°C	250 W		400 W		500 W		750 W	
Operating temperature range	-25°C - 70°C							
Fan air flow approx.	35 m ³ /h		35 m ³ /h		35 m ³ /h		44 m ³ /h	
Mounting	DIN rail							
Dimensions (H x W x D)	135 x 82 x 112 mm			165 x 82 x 112 mm			225 x 82 x 112 mm	
Housing material / colour	Aluminium / silver							
Weight	0.88 kg			0.97 kg			1.35 kg	
ELECTRICAL DATA								
Voltage / Frequency	230 V ~ 50/60 Hz	120 V ~ 50/60 Hz	230 V ~ 50/60 Hz	120 V ~ 50/60 Hz	230 V ~ 50/60 Hz	120 V ~ 50/60 Hz	230 V ~ 50/60 Hz	120 V ~ 50/60 Hz
Max. current	1.2 A	2.4 A	1.9 A	3.8 A	2.4 A	4.8 A	3.6 A	7.2 A
Connection	3 screw terminal block for standard or rigid wire 2.5 mm ²							
IP protection class	IP 20							
Certification	CE, cURus							

Note: PTC resistor self-regulating

Adjustable thermostat (NC) order no. 301110 on page 173

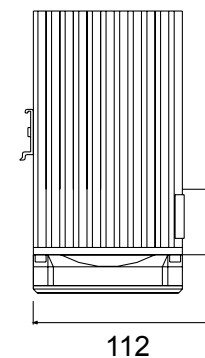
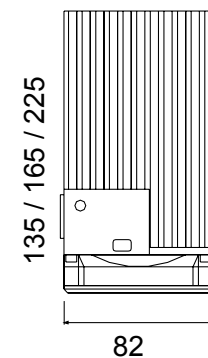



Enclosure heaters

Resistor heater with fan & thermostat

KH 801

- ✓ Adjustable thermostat
- ✓ Status indicator light
- ✓ Fan switch Auto / On
- ✓ Screw or DIN rail mounting

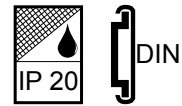

Model	RESISTOR HEATER			
Order number	801125A44001	801125A33001	801200A44001	801200A33001
Heating power at 10°C	125 W		200 W	
Operating temperature range	-20°C - 40°C			
Fan air flow approx.	27 m³/h			
Mounting	DIN rail			
Dimensions (H x W x D)	137 x 111 x 116 mm			
Housing material / colour	Aluminium / silver			
Weight	0.8 kg			
ELECTRICAL DATA				
Voltage / Frequency	230 V ~ 50/60 Hz	120 V ~ 60 Hz	230 V ~ 50/60 Hz	120 V ~ 60 Hz
Rated current	0.6 A	1.2 A	1 A	1.8 A
Fuse rating	2 A (T)		3 A (T)	
Connection	3 - pole pushfit connector			
IP protection class	IP 20			
Certification	CE, cURus			

24 V DC available on request

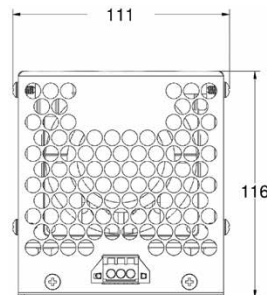
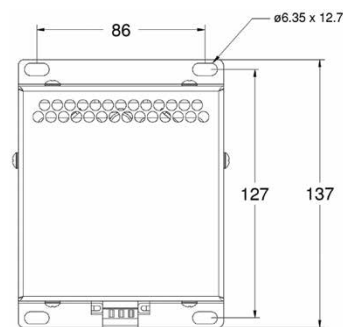

Enclosure heaters

Resistor / PTC heater with fan & thermostat

KH 801

- ✓ Adjustable thermostat
- ✓ Status indicator light
- ✓ Fan switch Auto / On
- ✓ Screw or DIN rail mounting



Model	RESISTOR HEATER				PTC HEATER	
Order number	801400A44001	801400A33001	801125A44001	801125A33001	8011K4A44001	8011K4A33001
Heating power at 10°C	400 W		800 W		1300 W	
Operating temperature range	-20°C - 40°C				-40°C - 70°C	
Fan air flow approx.	44 m³/h				83 m³/h	
Mounting	DIN rail					
Dimensions (H x W x D)	190 x 111 x 116 mm				190 x 126 x 155 mm	
Housing material / colour	Aluminium / silver					
Weight	0.8 kg				1.5 kg	
ELECTRICAL DATA						
Voltage / Frequency	230 V ~ 50/60 Hz	120 V ~ 60 Hz	230 V ~ 50/60 Hz	120 V ~ 60 Hz	230 V ~ 50/60 Hz	120 V ~ 60 Hz
Rated current	1.9 A	3.6 A	3.6 A	7.1 A	5.7 A	10.8 A
Fuse rating	3 A (T)	5 A (T)	5 A (T)	9 A (T)	10 A (T)	16 A (T)
Connection	3 - pole pushfit connector					
IP protection class	IP 20					
Certification	CE, cURus					

400 W and 800 W / 24 V DC available on request

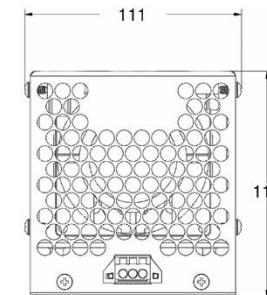
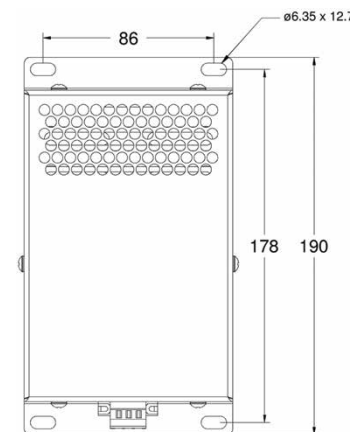

ACCESSORIES FOR MORE SAFETY INSIDE ENCLOSURES

SOLIFLEX thermostats, hygrometers and sensors



FOR TROUBLE FREE OPERATION INSIDE ENCLOSURES

SOLIFLEX thermostats and hygrometers ensure an optimal climate inside your enclosures or cabinets. They are available as normally closed, NC (red disk) or as normally open, NO (blue disk) and are supplied in a mechanical or an electronic version.

NC thermostats are used for regulating heaters or to trigger alarm signals when the enclosure temperature is falling below the preset minimum value. The contact opens when the temperature is rising. NO thermostats are used for regulating filter fans, heat exchangers, and Peltier cooling units or to trigger alarm signals when the preset temperature limit has been exceeded.

Temperature and humidity sensors can be plugged in to additionally monitor the preset parameters to ensure that failures or malfunctioning of equipment are avoided.



Enclosure accessories

Preset thermostats

CC 3010

- ✓ Fixed temperature setting °C or °F
- ✓ Very high switching accuracy
- ✓ Available in NO or NC models
- ✓ Small size
- ✓ Easy DIN rail mounting



Model	PRESET THERMOSTATS CC 3010					
Order number	301005	301010	301020	301030	301040	301050
Setting range	OFF 10°C / 50°F ON 0°C / 32°F	OFF 15°C / 59°F ON 5°C / 41°F	OFF 25°C / 77°F ON 15°C / 59°F	ON 35°C / 95°F OFF 25°C / 77°F	ON 50°C / 122°F OFF 40°C / 104°F	ON 60°C / 140°F OFF 50°C / 122°F
Operating temperature range	-45°C - 120°C					
Mounting	DIN rail 35 mm					
Dimensions (H x W x D)	60 x 39 x 38.9 mm					
Housing material / colour	PC plastic, RAL 7011					
Weight	~ 50 g					
ELECTRICAL DATA						
Voltage / Frequency	max. 250 V AC 16 A(res) / 10 A(ind) max. 72 V DC max. 30 W					
Switching point tolerance	Hyst.10±2K / Sw.Pt.tol ±2K					
Connection	2-pole terminal, clamping torque 0.5 Nm max. solid wire - 2.5 mm² max. stranded wire - 1.5 mm² max.					
IP protection class	IP 20					
Certification	CE, cURus					



Enclosure accessories

Adjustable thermostats

CC 3011

- ✓ Variable temperature setting °C or °F
- ✓ Very high switching accuracy
- ✓ Available in NO or NC models
- ✓ Small size
- ✓ Easy DIN rail mounting



Model	ADJUSTABLE THERMOSTATS CC 3011			
Order number	301110	301111	301120	301121
Setting range	-10°C - 80°C (NC)	14°F - 176°F (NC)	-10°C - 80°C (NO)	14°F - 176°F (NO)
Operating temperature range	-45°C - 120°C			
Mounting	DIN rail 35 mm			
Dimensions (H x W x D)	60 x 39 x 42.4 mm			
Housing material / colour	PC plastic, RAL 7011			
Weight	~ 50 g			
ELECTRICAL DATA				
Voltage / Frequency	max. 250 V AC 16 A(res) / 2 A(ind) max. 72 V DC max. 30 W			
Switching point tolerance	Hyst. 7±3K / Sw.Pt.tol ±4K			
Connection	2-pole terminal, clamping torque 0.5 Nm max. solid wire - 2.5 mm² max. stranded wire - 1.5 mm² max.			
IP protection class	IP 20			
Certification	CE, cURus			



Enclosure accessories

Twin thermostats, changeover thermostat, hygostat

CC 3012 - 3013 - 3014

- ✓ Variable temperature setting °C or °F
- ✓ Very high switching accuracy
- ✓ Available in NO or NC models
- ✓ Adjustable relative humidity
- ✓ Small size
- ✓ Easy DIN rail mounting



Model	ADJUSTABLE TWIN THERMOSTATS CC 3012					
Order number	301210	301211	301220	301221	301230	301231
Setting range	-10°C - 80°C (NCNC)	14°F - 176°F (NCNC)	-10°C - 80°C (NONO)	14°F - 176°F (NONO)	-10°C - 80°C (NCNO)	14°F - 176°F (NCNO)
Operating temperature range	-45°C - 120°C					
Mounting	DIN rail 35 mm					
Dimensions (H x W x D)	60 x 72.3 x 42.4 mm					
Housing material / colour	PC plastic, RAL 7011					
Weight	~ 110 g					
ELECTRICAL DATA						
Voltage / Frequency	max. 250 V AC 16 A(res) / 2 A(ind) max. 72 V DC max. 30 W					
Switching point tolerance	Hyst. 7±3K / Sw.Pt.tol ±4K					
Connection	2-pole terminal, clamping torque 0.5 Nm max. solid wire - 2.5 mm ² max. stranded wire - 1.5 mm ² max.					
IP protection class	IP 20					
Certification	CE, cURus					

Model	CHANGEOVER THERMOSTAT WITH THERMAL FEEDBACK CC 3013	MECHANICAL HYGROSTAT CC 3014	
Order number	301320	301321	301410
Setting range	0°C - 60°C	32°F - 140°F	30% - 90%r.H.
Operating temperature range	0°C - 60°C	32°F - 140°F	0°C - 60°C
Mounting	DIN rail 35 mm		
Dimensions (H x W x D)	60 x 39 x 53,3 mm		60 x 39 x 42,4 mm
Housing material / colour	PC plastic, RAL 7011		
Weight	64 g		
ELECTRICAL DATA			
Voltage / Frequency	AC: 250 V / 10 A(res) / 2 A(ind) DC: 72 V / 30 W UL: max.250 V AC NC/NO: 10 / 5 A(res)		max. 230 V AC 2 A (hum) / 5 A (dehum)
Switching point tolerance	Hyst. 4-7K/1K / Sw.Pt.tol ±3K		Hyst. 5%r.H. / Sw.Pt.tol ±4%
Connection	4-pole terminal, clamping torque 0.5 Nm max. solid wire - 2.5 mm ² max. stranded wire - 1.5 mm ² max.		3-pole terminal, clamping torque 0.5 Nm max. solid wire - 2.5 mm ² max. stranded wire - 1.5 mm ² max.
IP protection class	IP 20		
Certification	CE, cURus		



Enclosure accessories

Electronic thermostat, hygostat, sensors

CC 3015 - 3016

- ✓ Variable temperature setting °C or °F
- ✓ Very high switching accuracy
- ✓ Adjustable relative humidity
- ✓ Small size
- ✓ Easy DIN rail mounting



Model	ELECTRONIC THERMOSTAT CC 3015	SENSOR	
Order number	301510 (301512)	301511	301530
Setting range	0°C - 60°C	32°F - 140°F	-
Operating temperature range	-25°C - 70°C / 95% int. Sensor -25°C - 80°C / 95% ext. Sensor	-13 - 158°F / 95% int. Sensor -13 - 176°F / 95% ext. Sensor	-45°C - 120°C / 95%
Mounting	DIN rail 35 mm		Magnets
Dimensions (H x W x D)	60 x 39 x 53.3 mm		46.3 x 18 x 12.7 mm
Housing material / colour	PC plastic, RAL 7011		White
Weight	56 g		30 g
ELECTRICAL DATA			
Voltage / Frequency	24 V DC / 16 A		-
Switching point tolerance	Hyst. 3K (1K model 301512) / Sw. Pt. tol 3K		-
Connection	4-pole terminal, clamping torque 0.5 Nm max. solid wire - 2.5 mm ² max. stranded wire - 1.5 mm ² max.		Cable 1.8 m
IP protection class	IP 20		
Certification	CE, cURus		CE



Temperature sensor pluggable in Thermostat

Model	ELECTRONIC HYGROSTAT CC 3016	SENSOR	
Order number	301610	301630	
Setting range	30% - 90%r.H.	-	
Operating temperature range	-25°C - 70°C / 95% int. Sensor -25°C - 80°C / 95% ext. Sensor	-40°C - 85°C / 100%	
Mounting	DIN rail 35 mm		Magnets
Dimensions (H x W x D)	60 x 39 x 53,3 mm		46,3 x 18 x 12,7 mm
Housing material / colour	PC plastic, RAL 7011		Orange
Weight	60 g		30 g
ELECTRICAL DATA			
Voltage / Frequency	24 V DC / 16 A		-
Switching point tolerance	Hyst. 5%r.H. / Sw.Pt.tol ±10%		-
Connection	4-pole terminal, clamping torque 0.5 Nm max. solid wire - 2.5 mm ² max. stranded wire - 1.5 mm ² max.		Cable 1.8 m
IP protection class	IP 20		
Certification	CE, cURus		CE



Humidity sensor pluggable in hygostat

SO THAT YOU CAN SEE WHAT IS GOING ON INSIDE YOUR ENCLOSURE

STRIPLITE enclosure lights

MOTION SENSOR

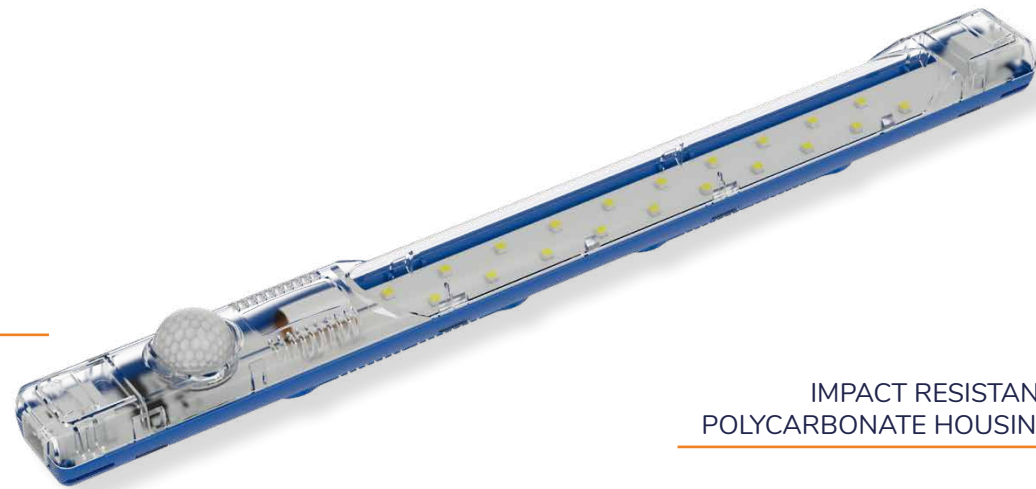

IMPACT RESISTANT
POLYCARBONATE HOUSING

AC / DC WIDE VOLTAGE RANGE
FOR UNIVERSAL USE



ON / OFF SWITCH

MAGNETS OR CLIPS
FOR EASY MOUNTING

PUSHFIT OR
CONNECTOR SYSTEM

ENERGY SAVING ENCLOSURE LIGHTING

STRIPLITE LED enclosure lights have been designed to meet the criteria of illuminating industrial enclosures and cabinets. They are equipped with either an ON / OFF switch or with a motion sensor.

Our 400 Lm version has a wide voltage range (24 - 265 V AC / DC) which allows a universal use with just one model. The more powerful 700 Lm version has a voltage range from 120 - 240 V AC.

Multiple LED lights can be connected in line using daisy chain cables. There are also various connecting options available.

The new SL 4905 LED enclosure light with 1500 Lm and integrated motion sensor has a powder coated mild steel housing and can optionally be supplied with a socket outlet and door contact switch.



STRIPLITE LED enclosure lights

SL 4000 - SL 4007

- ✓ AC/DC wide voltage range for a universal use
- ✓ With motion sensor or ON / OFF switch
- ✓ Light output 400 or 700 Lm
- ✓ Daisy chain cables available to connect multiple lights
- ✓ Connector system or pushfit for fast and easy installation
- ✓ Magnets, clips and DIN rail clip for custom made mounting



Model	SL 4000	SL 4007
Order no. with motion sensor, connector	400000	400076
Order no. with motion sensor, Pushfit	400400	-
Order no. with ON / OFF switch, connector	400100	400176
Order no. with ON / OFF switch, Pushfit	400500	-
Operating temperature range	-30°C -70°C	
Mounting	Magnets / Clips	
Max. number lamps to connect	16 (AC) / 8 (DC) pcs.	12 pcs.
Switch off time (motion sensor)	5 Min.	
Dimensions	357.4 x 32 x 35.5 mm	
Weight	140 g	
Housing material	PC transparent (top), PC blue (base)	PC frosted (top), PC blue (base)
ELECTRICAL DATA		
Voltage / Frequency	24-265 V DC / AC ~ 0 / 50/60 Hz	120-240 V ~ 50/60 Hz
Power consumption	4 Watt	8 Watt
Lamp type	LED, 120°, 7400K	LED, 120°, 6500K
Light output	400 lm	700 lm
Life time	50,000 hrs.@ 20°C	60,000 hrs. @ 20°C
Protection class	II (double insulated)	
IP protection class	IP 20	
Certification	CE, cURus	

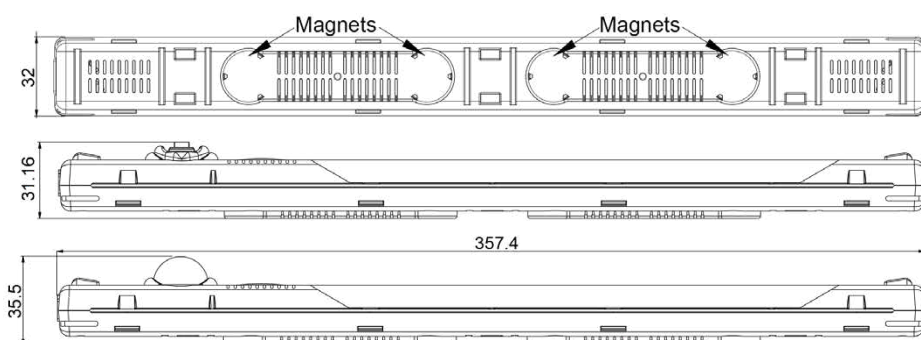

SL 4000 **G**

SL 4007 **F**

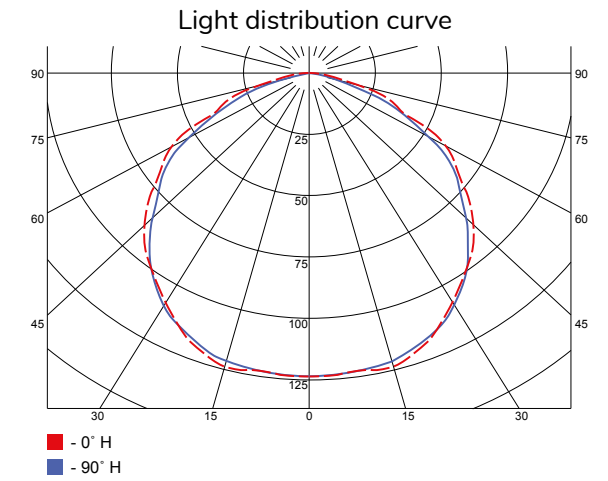
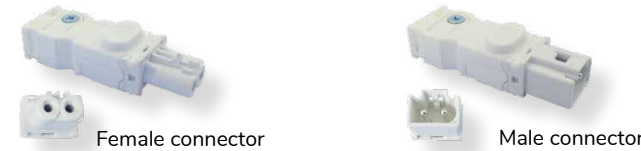
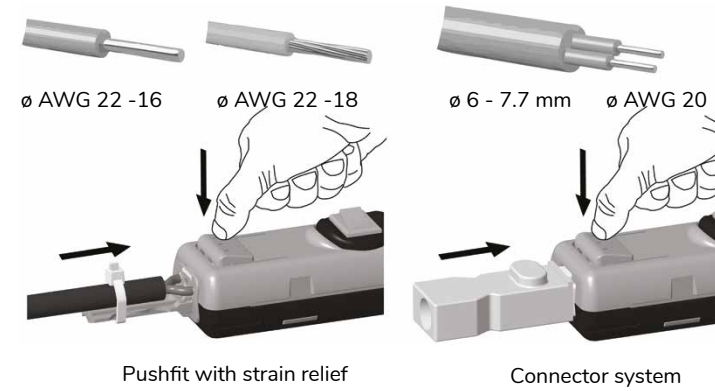

Order number	Description	Colour	Connection	Certification
400702	Female connector for cable Ø 6 - 7.7 mm, AWG 18-22	white	Screw connection	CE, cURus
400703	Male connector for cable Ø 6 - 7.7 mm, AWG 18-22	white	Screw connection	CE, cURus
400711	Power cable 2 x AWG 18, halogen free, female connector, 3 m	white	Plug connection	CE, cURus ¹⁾
400712	Power cable 2 x AWG 18, halogen free, female connector, 3 m	orange	Plug connection	CE, cURus ¹⁾
400721	Daisy chain cable 2 x AWG 18, halogen free, male / female connector, 0,5 m	white	Plug connection	CE, cURus ¹⁾
400722	Daisy chain cable 2 x AWG 18, halogen free, male / female connector, 0,5 m	orange	Plug connection	CE, cURus ¹⁾
400731	Daisy chain cable 2 x AWG 18, halogen free, male / female connector, 1 m	white	Plug connection	CE, cURus ¹⁾
400732	Daisy chain cable 2 x AWG 18, halogen free, male / female connector, 1 m	orange	Plug connection	CE, cURus ¹⁾
400742	Power cable 2 x AWG 18, halogen free, door switch, female connector, 3,5 m	orange	Plug connection	CE, cURus ¹⁾
AC-SL400Clip-CY-1	DIN rail clip, 2 pcs.	transparent	Clip	-

¹⁾ applies only to individual components, connector and cable

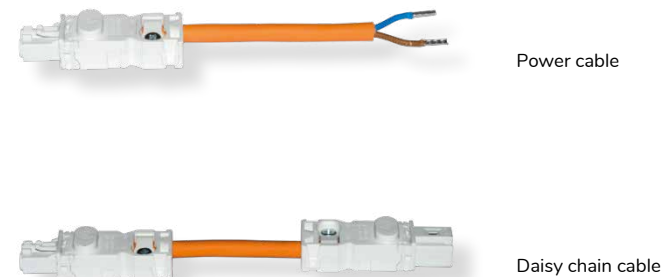

Power cable 2 x AWG 18, halogen free, door contact switch, female connector normally closed (NC) wired, strain relief, mounting plate





STRIPLITE LED enclosure lights

SL 4905

- ✓ Wide voltage range for universal use with a single model
- ✓ With motion sensor and power socket (optional)
- ✓ Light output 1,500 Lm
- ✓ Daisy chain cables available to connect multiple lights
- ✓ Connector system for fast and easy installation
- ✓ Screw mounting
- ✓ Universally positionable door switch as an accessory, overwrites the motion sensor



Model	SL 4905			
Order no. with motion sensor	490540612			490560612
Order no. with motion sensor, SCHUKO plug and Daisy Chain		490502612		
Order no. with motion sensor, SCHUKO plug, Daisy Chain, door switch ready		490504612		
Order no. with motion sensor, NEMA plug and Daisy Chain			490513612	
Order no. with motion sensor, NEMA plug, Daisy Chain, door switch ready			490515612	
Order no. with motion sensor, Daisy Chain				490561612
Order no. with motion sensor, Daisy Chain, door switch ready				490566612
Order no. door switch, cable, connector	490505			
Operating temperature range	-20°C - 50°C			
Mounting	Screw mounting (M5)			
Max. number lamps to be connected	-			10 pcs.
Switch off time motion sensor	5 Min.			
Dimensions (A x B x C)	420 x 90 x 45 (79 with door contact switch) mm			
Weight	2 kg			
Housing material / diffuser	Mild steel powder coated, RAL 9003 / V0 flame retardant clear polycarbonate			
ELECTRICAL DATA				
Voltage / Frequency	115-230 V ~ 50/60 Hz	230 V ~ 50/60 Hz	115 V ~ 60 Hz	24 V DC ¹⁾
Max. power consumption	16 Watt		12 Watt	
Max. current	0.2 A	16.8 A	12.2 A	5 A
Recommended external fuse rating	0.5 A (T)	17 A (T) or C16 MCB		7 A (T)
Connection wire	0.20 mm ² AWG 24	2.5 mm ² AWG 14	1 mm ² AWG 18	
Lamp type	LED, 120°, 5000K			
Light output	1,500 lm			
Life time	60,000 hrs. @ 20°C			
IP protection class	IP 20			
Certification	CE, cURus			

¹⁾ Use only SELV DC power sources. In case of UL applications only listed class 2 power supplies must be used.

Note: Light source used EB 7801, energy efficiency class E

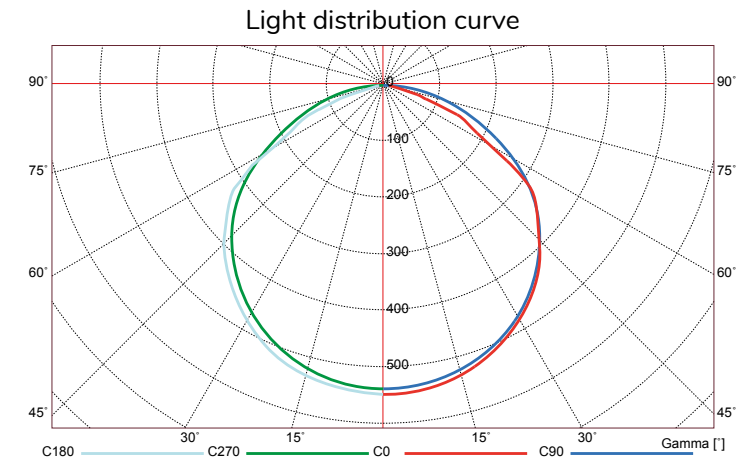

Electrical outlet variations

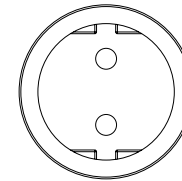

SCHUKO

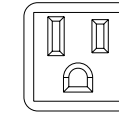

NEMA

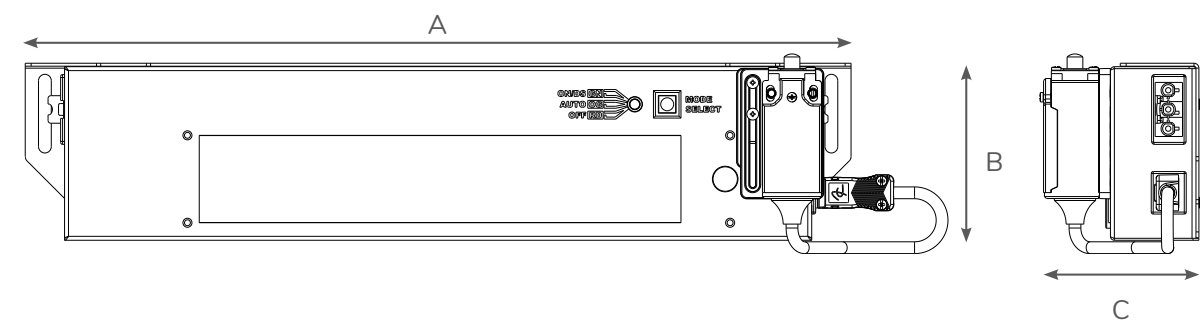
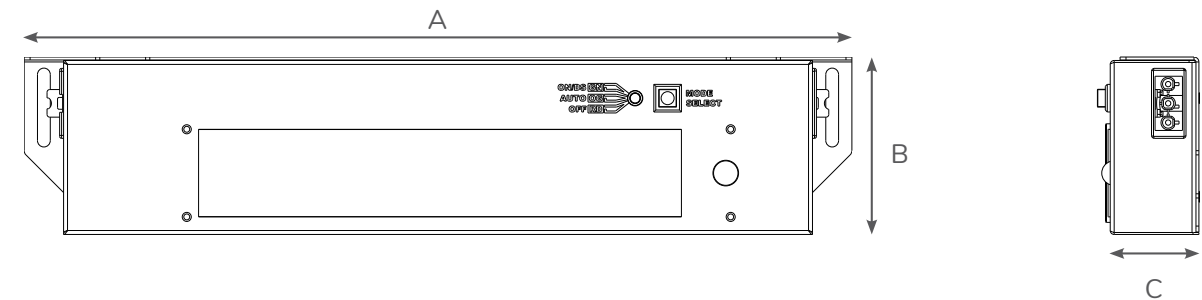

IP protection classes according to EN 60529

The abbreviation "IP" stands for "International Protection" whereby the term "Ingress Protection" is also used. The two digits after "IP" provide information about the influences against which a product is protected. The 1st digit describes the degree of protection of the housing against contact and protection against foreign bodies whilst the 2nd digit represents the protection of the housing against moisture or ingress of water. The following overview table describes the most common IP protection classes.

The degree of protection in the technical data of our products defines the degree of protection required for the enclosure.

1 st Digit ▶	Protection against solid foreign bodies			Protection against dust in damaging quantities	Complete protection against ingress of dust
	Ø ≥ 50 mm	Ø ≥ 2.5 mm	Ø ≥ 1.0 mm	(dust protected)	(dust proof)
No protection against water	IP 20	IP 30	IP 40	IP 50	IP 60
Protection against vertically falling water drops	IP 21	IP 31	IP 41	IP 51	IP 61
Protection against sloping (up to 15°) falling water drops	IP 22	P 32	IP 42	IP 52	IP 62
Protection against spraying water	IP 23	IP 33	IP 43	IP 53	IP 63
Protection against splashing water	IP 24	IP 34	IP 44	IP 54	IP 64
Protection against water jets	IP 25	IP 35	IP 45	IP 55	IP 65
Protection against powerful water jets	IP 26	IP 36	IP 46	IP 56	IP 66
Protection against temporary immersion in water	IP 27	IP 37	IP 47	IP 57	IP 67
Protection against continuous immersion in water	IP 28	IP 38	IP 48	IP 58	IP 68

Classification according to the UL standard (UL 50E) for the safety of enclosures for electrical devices.

Type	Area	Protection	Comparable IP
Type 1	Indoor	Protection against contact with enclosed equipment and against a limited amount of falling dirt.	IP 10
Type 3	Outdoor	Protection against windblown dust and rain. Undamaged by the formation of ice on the enclosure.	IP 54
Type 3R	Outdoor	Protection against falling rain, sleet and snow. Undamaged by the formation of ice on the enclosure.	IP 14
Type 4	Indoor / Outdoor	Protection against falling rain, splashing water, and hose-directed water. Undamaged by the formation of ice on the enclosure.	IP 56
Type 4X	Indoor / Outdoor	Protection against falling rain, splashing water, and hose-directed water. Undamaged by the formation of ice on the enclosure. Provides an increased level of corrosion protection.	-
Type 12	Indoor	Protection against dust, dirt, fiber flyings, dripping water, and external condensation of oil and non-corrosive liquids.	IP 52



The National Electrical Manufacturers Association (NEMA) Standard "Enclosures for Electrical Equipment" (max. 1,000 V) NEMA-250 provides a similar type rating, however it does not require independent testing and leaves compliance up to the manufacturer. UL 50E requires testing, and follow-up inspection of equipment directly by UL.

Note: IP and NEMA / Type protection classes are not directly but only approximately comparable.

CE Marking and European directives

Symbol / Directive	Description
	'CE marking' as defined by Regulation (EC) 765/2008 is a marking by which the manufacturer indicates that the product is in conformity with the applicable requirements set out in Community Harmonisation Legislation providing for its affixing i.e., the products made available on the market have been assessed to meet all the applicable EU requirements namely, the safety, health, and environmental protection requirements.
	The UKCA (UK Conformity Assessed) marking is a new UK product marking that is used for goods being placed on the market in Great Britain (England, Wales and Scotland). It covers most goods which previously required the CE marking.
Machinery Directive 2006/42/EC	Harmonising the health and safety requirements applicable to machinery based on a high level of protection of health and safety, while ensuring the free circulation of machinery on the EU market.
Low Voltage Directive 2014/35/EU	This Directive ensures that electrical equipment operating within certain voltage limits provides a high level of protection. The LVD protects people from health and safety hazards when they use electrical equipment with input or output voltages of 50 to 1,000 V for alternating current and 75 to 1,500 V for direct current. It covers a wide range of consumer and professional electrical equipment, including household appliances, cables, power supply units, laser equipment, and certain components, such as fuses.
EMC Directive 2014/30/EU	This Directive regulates the electromagnetic compatibility of equipment. It aims to ensure the functioning of the internal market by requiring equipment to comply with an adequate level of electromagnetic compatibility.
ROHS Directive 2011/65/EU	This Directive lays down rules on the restriction of the use of hazardous substances in electrical and electronic equipment (EEE) with a view to contributing to the protection of human health and the environment, including the environmentally sound recovery and disposal of waste EEE.
ATEX Directive 2014/34/EU	This Directive covers equipment and protective systems intended for use in potentially explosive atmospheres. The directive defines the essential health and safety requirements and conformity assessment procedures, to be applied before products are placed on the EU market.
Harmonised standards	A harmonised standard is a European standard developed by a recognised European Standards Organisation: CEN, CENELEC, or ETSI. It is created following a request from the European Commission to one of these organisations. Manufacturers, other economic operators, or conformity assessment bodies can use harmonised standards to demonstrate that products, services, or processes comply with relevant EU legislation. The references of harmonised standards must be published in the Official Journal of the European Union.

North American Certification Marks

Symbol	Description
 C: Certified for Canada, US: for US, no additional letters: for US only.	The UL listed mark appears on end products and complete components suitable for factory and field installation. All of the products carrying these marks are covered by the UL Follow-Up Services Program to determine that products continue to be manufactured in compliance with UL's safety requirements.
 C: Certified for Canada, US: for US, no additional letters: for US only.	Components covered by UL's recognised component program are intended to be installed in another device, system or end product. They are to be installed at the factory, not in the field and they may have restricted performance capabilities that limit their use. Guidelines addressing the suitability of a component when used in an end product are noted in UL's test report as conditions of acceptability.
 C: Certified for Canada, US: for US, no additional letters: for Canada only.	The CSA mark shows that the product has been tested against and has met the requirement of the applicable North American standards requirements.
UL categories:	Description
UL - ACVS	Air conditioners, special purpose
UL - FTFA	Ensures that the type rating (protection class) of an enclosure is retained, even if a mounting cutout for installation of a climate control component is applied. No further testing of the enclosure required.

The right product for your applications

With the following information we would like to support our customers in choosing the right product. We provide an overview of the various cooling methods and explain where and when which device is best used.

Why do we need enclosure cooling?

Through the increasing automation of production processes, more and more electro technical components are being used. These components generate a lot of power loss which converts into heat. The increasing temperatures inside the enclosures have a negative influence on the life cycle of the components inside.

Supporting process reliability and keeping service intervals within economic reasons, are the main challenges thermal management of industrial enclosures is facing today. Therefore the choice of the right cooling method is very important.

The most common cooling methods used are:

1. Natural convection

If your application has only a small heat loss, openings in your enclosure with louvers or grills with filters can be effective enough. However in most cases this method does not provide enough cooling for today's electronic components.

Rule of thumb:

- depending on the heat load inside the enclosure and the temperature outside, the enclosure temperature is likely to be higher than the ambient temperature.
- if this is the case, the heat is dissipated via the enclosure surface.
- the application is then maintenance free.
- dirt is just as damaging to electronic components as excessive temperatures. Outlet filters can prevent the ingress of dirt.

2. Forced convection

If your installation is in a clean, non-hazardous environment with an ambient temperature less than the desired enclosure temperature, a simple forced ventilation system utilising the ambient air is usually sufficient. Filter fans combined with exhaust filters can generally meet the heat dissipation needs of modern electronic components.

Rule of thumb:

- calculated rise should be at least +10 Kelvin above ambient temperature
- filter fan combinations can be installed in different positions of the enclosure.
- when selecting the filter fan, the resulting overpressure in the enclosure must be taken into account.

3. Cooling through a closed cooling circuit

If your application is installed in an environment with high ambient temperatures, oil and dust exposure and you have high splash proof requirements (NEMA / IP), then it becomes absolutely necessary to prevent the ambient air from entering the enclosure. A cooling system with closed loop cooling normally consists of 2 circuits; one circuit closes the ambient air off and cools and circulates clean air into the enclosure the second circuit uses the ambient air or water to dissipate the heat. For these kind of applications cooling units and air / water heat exchangers are normally used.

Rule of thumb:

- the only method to reduce enclosure temperature below ambient temperature (using cooling units and air / water heat exchangers)
- suitable for high NEMA / IP requirements
- during planning you need to take the ambient temperature and the generated power loss into consideration. For outdoor applications, please also consider the solar load (check the performance charts of the product you want to use to ensure that your system temperature is properly maintained).

The right selection of a cooling unit / heat exchanger is determined by the following criteria:

- required cooling capacity [W]
- max. ambient air temperature and desired enclosure air temperature
- mounting requirements (wall, recessed or top mount)
- dimensions of cooling unit and enclosure
- mounting environment (indoor, outdoor, shading, etc.)

Use our **CalCoolator** (<https://www.seifertsystems.com/en/calcoolator/>) in order to make sure that your cooling device meets the required parameters.

Furthermore, the following should be noted:

1. the enclosure should be sealed to prevent the inflow of ambient air
2. the NEMA / IP rating of the cooling unit and of the enclosure should be the same
3. use a door contact switch to prevent operation with open doors
4. ensure that the external circuit has a good air inflow and air outflow, so that the heat can be dissipated into the environment
5. it also must be ensured that components with a high level of self-ventilation do not direct the air into the cold air outlet of the cooling device.
6. ensure the enclosure is standing straight.
7. setting the temperature to the lowest is not always the best solution. The preset value of +35°C is a good compromise ensuring long life of electrical components, efficient operation and minimum condensation.

The right use of enclosure cooling units

Cooling units are used when:

- the necessary heat dissipation can no longer take place constantly via the ambient air
- the required temperature inside the enclosure should be the same as or lower than the ambient temperature
- the ambient air is heavily polluted or there is increased humidity

When buying a cooling unit, pay attention to the coefficient of performance (COP)

Enclosure cooling units work like a heat pump and consequently consume electrical energy, which generates expenses. How efficiently a cooling device converts this energy into cooling performance is described by the coefficient of performance (COP). This value defines how economically a cooling unit works; the higher this value, the better.

The correct use of heat exchangers

Air / air heat exchangers are used when cool ambient air is available but should not enter the enclosure because of contamination. Air / air heat exchangers are mainly used in outdoor applications.

Air / water heat exchangers are mainly used when a cold water supply is available and high power losses in small areas need to be dissipated.

The correct use of chillers

The cooling of liquids is a reliable and proven way to dissipate heat from machines, machining centers, server applications and in the medical sector. When choosing a chiller, the most important thing is the cooling medium used. This can consist of oils, an antifrogen / water mixture or deionised water. Depending on the cooling medium, the design of the chiller must be adapted accordingly.

We offer chillers with cooling capacities from 1.5 kW to 12 kW which we adapt if necessary to the respective customer requirement.

The correct use of Peltier cooling units

Peltier cooling units are based on the "Peltier" effect which is derived from name of its inventor. When DC voltage is applied, thermoelectric elements generate a temperature difference which in combination with surface enlarging heat sinks and forced ventilation, cause cooling inside the enclosure. The heat is dissipated into the environment via a separate ambient heat sink.

Peltier cooling units are mainly used to dissipate the heat of smaller power losses (30 - 800 W). They operate without refrigerant, have no compressor and no pressure circuit, thus they can be installed in almost any position. Depending on the mounting situation the condensation management may need to be considered and possibly adjusted. With a protection rating of IP 66 they can be used both for indoor and outdoor applications.

The correct use of filter fans

Filter fans and exhaust filters are used when the desired enclosure temperature may constantly be above the ambient temperature. Combined with thermostats, additional energy can be saved; the fan only runs when actually needed. This results in less consumption of filter mats and less maintenance, extending the service life of the filter fans and improving process reliability.

If you install a combination of filter fan and exhaust filter, the filter fan should always be placed in the lower third of the enclosure and the exhaust filter in the upper part of the enclosure in order to prevent heat pockets.

The correct use of enclosure heaters

Temperature differences in enclosures, mostly in outdoor applications, often result in humidity and condensation which may cause malfunctions and corrosion.

The use of the appropriate heating unit will eliminate these problems. Fan heaters distribute the internal warm air equally throughout the enclosure. PTC heaters are compact in size, have a wider voltage range and the heating power adjusts in relation to the ambient temperature resulting in very good efficiency.

Using enclosure accessories correctly

Thermostats and hygrometers ensure an optimal climate inside your enclosures or cabinets. Thermostats are available either as normally closed NC (red disk) or as normally open NO (blue disk). NC thermostat are used for regulating heaters or for alarm signals when the enclosure temperature is falling below the preset minimum value. The contact opens when the temperature is rising.

NO thermostats are used for regulating filter fans, heat exchangers and Peltier cooling units or for switching alarm signals when the preset temperature limit has been exceeded. In addition our temperature and humidity sensors can monitor the preset parameters to ensure that failures or equipment malfunctioning can be avoided.

Hygrometers are used to limit the humidity inside enclosures. Internal sensors record the moisture content and the room temperature and calculate the optimal humidity for the measured temperature. If this exceeds the preset value, heaters can be switched on.

Pluggable temperature and humidity sensors can additionally monitor the preset parameters to ensure that failures or malfunctioning of equipment can be avoided.

STRIPLITE LED enclosure lights have been designed to meet the criteria of illuminating industrial enclosures and cabinets. They are available either with On / Off switches or with motion sensors. A wide voltage range and the possibility to connect multiple lights together allow the universal use of these enclosure lights.

Explanation of the symbols used in this catalogue

Mounting options



Wall mounted



Recessed



Internal



Roof mounted



19" Rack



DIN rail



Tool free installation

Protection classes according to IEC 60529



IP 20



IP 44



IP 54



IP 55



IP 56



IP 66

The exact explanation of the individual protection classes can be found on page 182.

Other symbols



Large distance between air inlet and air outlet



No filters used



Tool free filter change



Maintenance free



Low noise

THE SEIFERT SYSTEMS GROUP



SEIFERT SYSTEMS GmbH Germany

Albert-Einstein-Str. 3
42477 Radevormwald

+49 2195 68994-0
info.de@seifertsystems.com
www.seifertsystems.com



SEIFERT SYSTEMS Ltd. Malta

HF 09/10, Hal Far Industrial Estate
Birzebbuga BBG 3000

+356 2220 7000
info@seifertsystems.com
www.seifertsystems.com



SEIFERT SYSTEMS GmbH Austria

Bärnthäl 1
4901 Ottnang

+43 7676 207120
info.at@seifertsystems.com
www.seifertsystems.com



SEIFERT SYSTEMS AG Switzerland

Wilerstraße 16
4563 Gerlafingen

+41 32 6753551
info.ch@seifertsystems.com
www.seifertsystems.com



SEIFERT SYSTEMS Ltd. Italy

Sales office
26100 Cremona

+39 349 2594524
info.it@seifertsystems.com
www.seifertsystems.com

SEIFERT SYSTEMS Ltd. Scandinavia / Baltic states

Sales office
25421 Pinneberg

+49 2195 68994-40
info.sk@seifertsystems.com
www.seifertsystems.com



SEIFERT SYSTEMS SA France

Wilerstraße 16
CH - 4563 Gerlafingen

+33 7 65298156
info.fr@seifertsystems.com
www.seifertsystems.com



SEIFERT SYSTEMS Inc. USA

75 Circuit Drive
North Kingstown, RI 02852

+1 401-294-6960
info.us@seifertsystems.com
www.seifertinc.com



C. D. Automation Pvt. Ltd. India

8, Parsee Church Street, 3rd floor
Kolkata - 7000 001

+91 33 2215 7080
ananda.roy@seifertsystems.com
www.cdautomation.co.in



SEIFERT SYSTEMS Pty Ltd. Australia

105 Lewis Road
Wantirna South, Victoria 3152

+61 3 98011906
info@seifertsystems.com.au
www.seifertsystems.com.au



