

Filter fan SF 4711 - 120V



Description

Order Number:	4711122001
Brand Name:	SOLIVENT PRO
Color:	RAL 7035
Housing Material:	PC plastic
Ingress protection to EN 60 529:	IP 54
UL Typ (UL 50E):	12
Approvals:	CE, cURus, cULus
UL File Number:	E498756

Technical data

Air flow unimpeded IP 54:	12.6 / 13.3 CFM
Air flow with exhaust filter IP 54:	6.9 / 7.6 CFM
Air flow with 2 exhaust filters IP 54:	9.8 / 10.5 CFM
Operating temperature range:	14°F - 140°F
Storage temperature range:	-40°F - 158°F
Mounting:	Wall mounted
Dimension H x W x D:	4.55 x 4.55 x 3.17 inches
Weight:	0.66 lbs.
Cut out dimensions:	3.62 x 3.62 inch
Voltage / Frequency:	120 V ~ 50/60 Hz
Rated current:	0.22 / 0.21 A
Power consumption:	3.2 / 3.3 W
Noise level:	32 dB(A)
Fuse:	1 A (T)
Connection:	Spring clamp

Air flow:

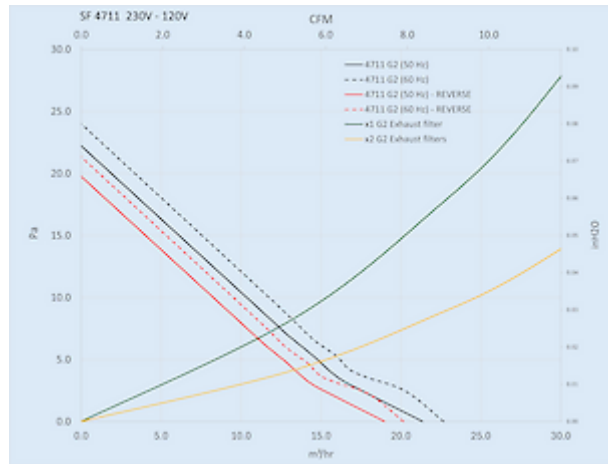

Cooling capacity:

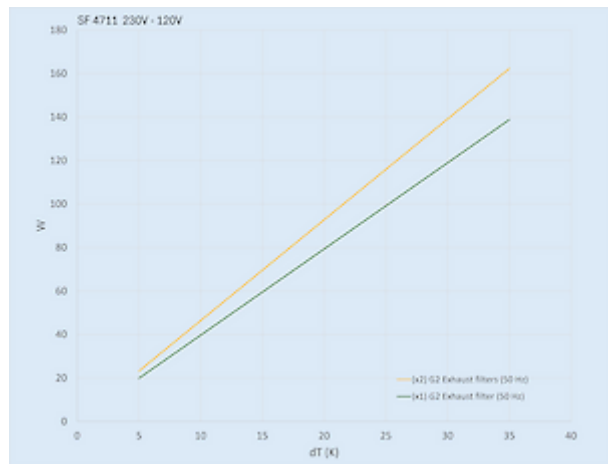

Cut out Dimensions:

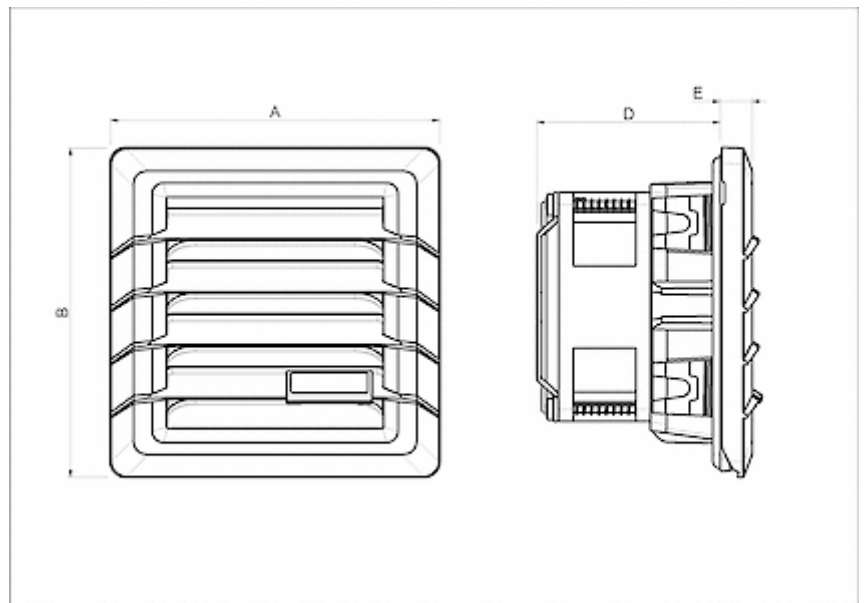

Order Information

Order number	IP rating	UL Type	RAL colour	Flow type ¹⁾	Air flow (m ³ /h) ²⁾	Air flow with exhaust filter (m ³ /h)
4711122001	54	12 / 3R	RAL 7035	B	21 / 23 m ³ /hr	12 / 13 m ³ /hr
4711122003	54	12 / 3R	RAL 9005	B	21 / 23 m ³ /hr	12 / 13 m ³ /hr
471112R2001	54	12 / 3R	RAL 7035	S	19 / 20 m ³ /hr	N/A
471112R2003	54	12 / 3R	RAL 9005	S	19 / 20 m ³ /hr	N/A

¹⁾ B = Blowing - from ambient into the enclosure (standard version)
 S = Suction - from enclosure to ambient (on request)

²⁾ unimpeded 50/60 Hz