

Filter fan SF 4720 - 120V



Description

Order Number:	4720122203
Brand Name:	SOLIVENT PRO
Color:	RAL 9005
Housing Material:	PC plastic
Ingress protection to EN 60 529:	IP 54
UL Typ (UL 50E):	12, 3R
Note:	IP 55 with filter O3 (see manual)
Approvals:	CE, cURus, cULus
UL File Number:	E498756

Technical data

Air flow unimpeded IP 54:	46.4 / 53.3 CFM
Air flow with exhaust filter IP 54:	29.4 / 34.1 CFM
Operating temperature range:	-40°F - 158°F
Storage temperature range:	-40°F - 158 °F
Mounting:	Wall mounted
Dimension H x W x D:	8.05 × 8.05 × 3.89 inches
Weight:	2.43 lbs.
Cut out dimensions:	6.97 x 6.97 inch
Voltage / Frequency:	120 V ~ 50/60 Hz
Rated current:	0.26 / 0.26 A
Power consumption:	21 / 18 W
Wall thickness:	0.039 - 0.118 inch
Noise level:	45 dB(A)
Fuse:	1 A (T)
Connection:	Spring terminal

Air flow:



Cooling capacity:

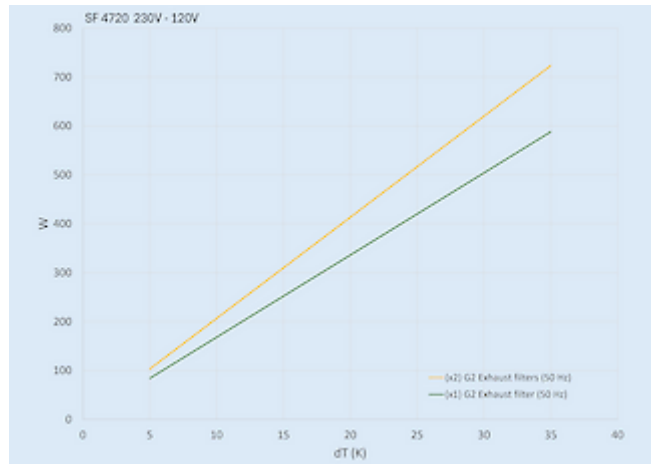

Cut out Dimensions:

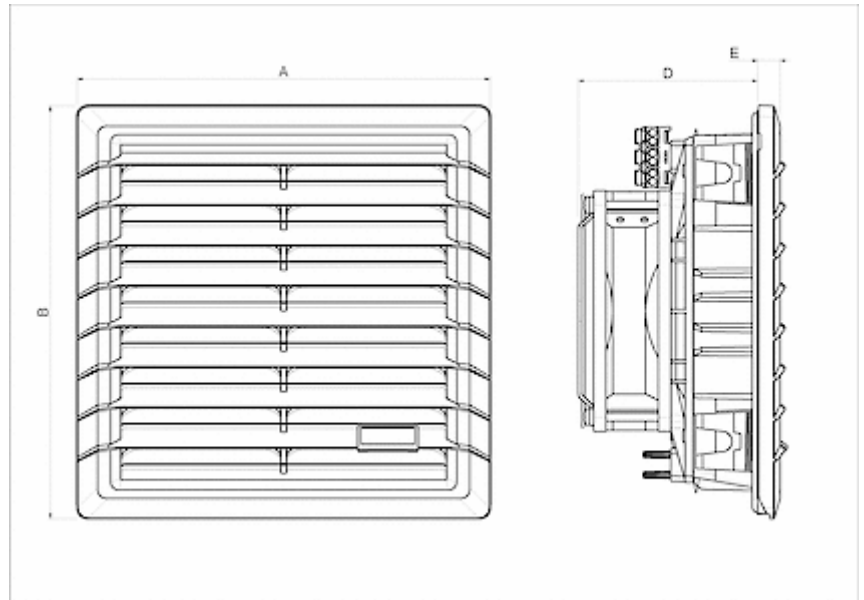

Order Information

Order number	IP rating	UL Type	RAL colour	Flow type ¹⁾	Air flow (m ³ /h) ²⁾	Air flow with exhaust filter (m ³ /h)
4720122201	54	12 / 3R	RAL 7035	B	79 / 91 m ³ /hr	50 / 58 m ³ /hr
4720122203	54	12 / 3R	RAL 9005	B	79 / 91 m ³ /hr	50 / 58 m ³ /hr
4720123201	55	12 / 3R	RAL 7035	B	69 / 84 m ³ /hr	45 / 53 m ³ /hr
4720123203	55	12 / 3R	RAL 9005	B	69 / 84 m ³ /hr	45 / 53 m ³ /hr
472012R2201	54	12 / 3R	RAL 7035	S	N/A	N/A
472012R2203	54	12 / 3R	RAL 9005	S	N/A	N/A
472012R3201	55	12 / 3R	RAL 7035	S	N/A	N/A
472012R3203	55	12 / 3R	RAL 9005	S	N/A	N/A

¹⁾ B = Blowing - from ambient into the enclosure (standard version)
 S = Suction - from enclosure to ambient (on request)

²⁾ unimpeded 50/60 Hz